

CATALOG

SACE Tmax XT

Low voltage molded case circuit-breakers



Break new ground

- Data and connectivity
- Ease of use and installation
- Performance and protection
- Safety and reliability

—
Break new ground.

A cutting-edge molded case circuit-breaker range delivering a brand new product experience, with extreme performance and protection features up to 1600A, maximizing ease of use, integration and connectivity. Built to deliver safety, reliability and quality.

SACE Tmax XT

The complete offering

MAIN
CHARACTERISTICS

01

THE RANGES

02

PROTECTION
TRIP UNITS

03

COMMUNICATION AND
CONNECTIVITY

04

ENERGY
MEASUREMENTS

05

SOLUTIONS

06

ACCESSORIES

07

ORDERING CODES

08

Main characteristics

1/2 SACE Tmax XT overview

1/4 Distinctive features

Products conformity

1/12 Compliance with Standards

1/13 Company quality system

1/13 Environmental Health & Safety Management System,
Social Responsibility and Ethics

1/13 Product Material Compliance

Construction characteristics

1/14 Double insulation

1/14 Positive operation

1/14 Insulation behaviour

1/14 Tropicalization

SACE Tmax XT overview

Break new ground

Break new ground simply means delivering value through the entire customer journey by leaving behind the traditional concept of circuit-breaker. The SACE Tmax XT range offers a unique customer experience that, sharing the same features and logics with the Emax 2 range, for the first time ever overcomes the differences between molded case and air circuit-breakers. The most advanced products designed to maximize data and connectivity, ease of use and installation, performance and protection, safety and reliability.

The SACE Tmax XT range offers higher performance, better protection and more precise metering than equivalent units, and can handle from 160 up to 1600A.

Combined with the world's most precise electronic trip units in the smallest frames, the new range delivers significant time savings and enhances installation quality.

Reliability is further increased, and speed of installation reduced, thanks to Bluetooth and Ekip connectivity for mobile devices.



The SACE Tmax XT family's built-in connectivity links smartphones, tablets and PCs to data analysis tools on the ABB Ability™ cloud platform in real time. The extreme precision of the data measured means users have access to accurate information anywhere and anytime, making it easier to monitor resources and identify savings opportunities. Using the embedded smart power controller can help reduce energy consumption by up to 20 per cent.

Upgrading the breakers is straightforward: for the first time, customers can download new functions from the ABB Ability Marketplace™, choosing from among more than 50 different protection, metering and automation functionalities.



Distinctive features

Data and connectivity



Plant management of the future – SACE Tmax XT sets standards in modern plant and energy management. Access, monitor and control information remotely, anywhere, at any time. Improving efficiency and saving energy.



The SACE Tmax XT is the first molded case circuit-breaker to become an active element inside the electrical plant without using external accessories.

Local connection

Commissioning and device setting have never been so easy thanks to the Bluetooth connectivity and the Ekip Connect software.

Remote communication

All the data of the electrical plant are accessible and the interaction with the breakers from remote is straightforward thanks to the several communication protocols available.

Cloud connectivity

Cloud connection is now possible to exploit the full service of ABB Ability™ EDCS thanks to the Ekip Com HUB.

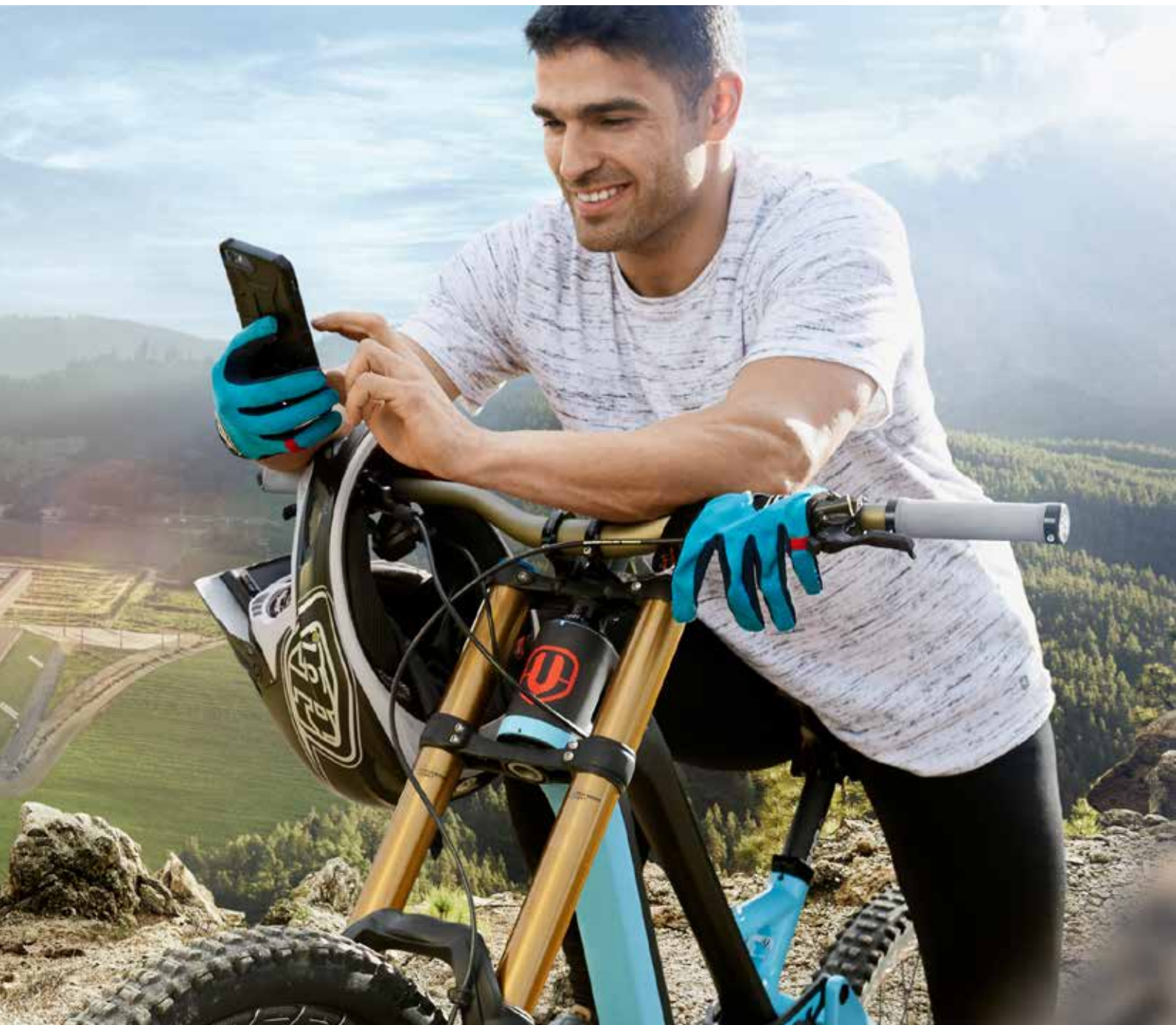

Distinctive features

Ease of use and installation



Maximum flexibility for every application – SACE Tmax XT sets standards for electrical installations. Easy selection, one-fits-all accessories and intuitive design pave the way for fast upgrades and create values through the entire customer journey. Even for the most critical projects.



Ease of selection

The clever organization of the SACE Tmax XT range and the user-friendly software e-Configure allows the customer to easily select and customize the right products for their needs.

One-fits-all accessories

Improving the circuit-breaker from its basic functions

to a more versatile and sophisticated device is made possible thanks to the SACE Tmax XT modular structure and the variety of available accessories.

Upgradability

The Ekip Touch and Hi-Touch trip units can always be upgraded via ABB Ability Marketplace™ and new functionalities shall be always available for an ever ending future.

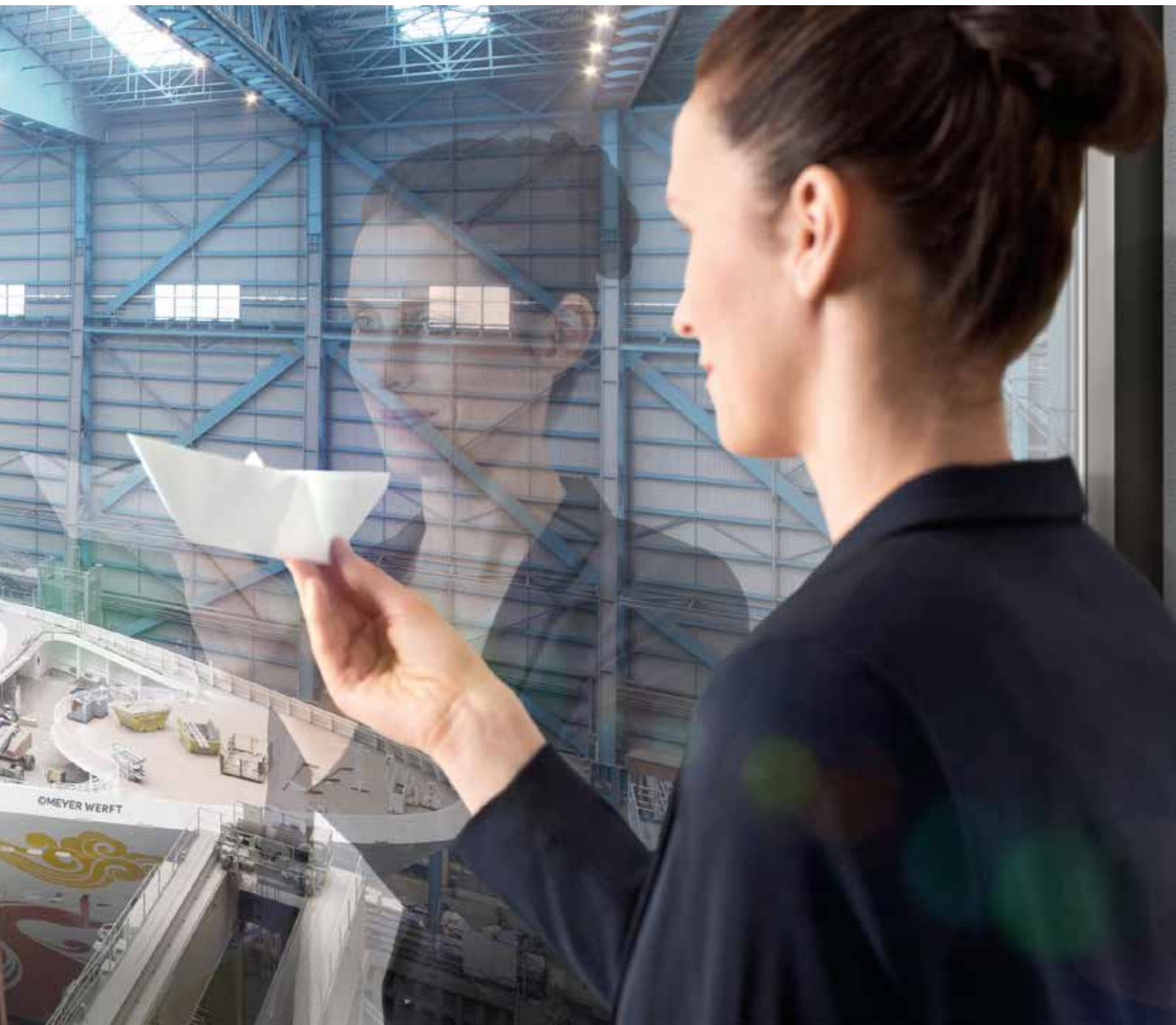

Distinctive features

Performance and protection



Continuity of service and equipment protection – SACE Tmax XT sets standards when extreme breaking capacity is needed. Sharing the same logics, interfaces and features regardless of operating voltage environmental conditions. Embedding the most advanced protections into the smallest of frames.



Electrical performances

SACE Tmax XT is designed and tested to meet any installation requirement, even the most critical ones.

Metering

SACE Tmax XT provides all the tools needed to set up a competent and effective energy management strategy thanks to the trip units able to measure electrical parameters with 1% accuracy certification.

Protections and logics

SACE Tmax XT integrates extra functionalities into the size of a standard molded case circuit-breaker.

The most advanced protection functions and logics are available thanks to its cutting-edge trip units.



Distinctive feature

Safety and reliability



Absolute attention to detail, with style from design to manufacturing SACE Tmax XT sets standards for edge technologies. Half a century of research and experience means top-level products that are ready to face future challenges.

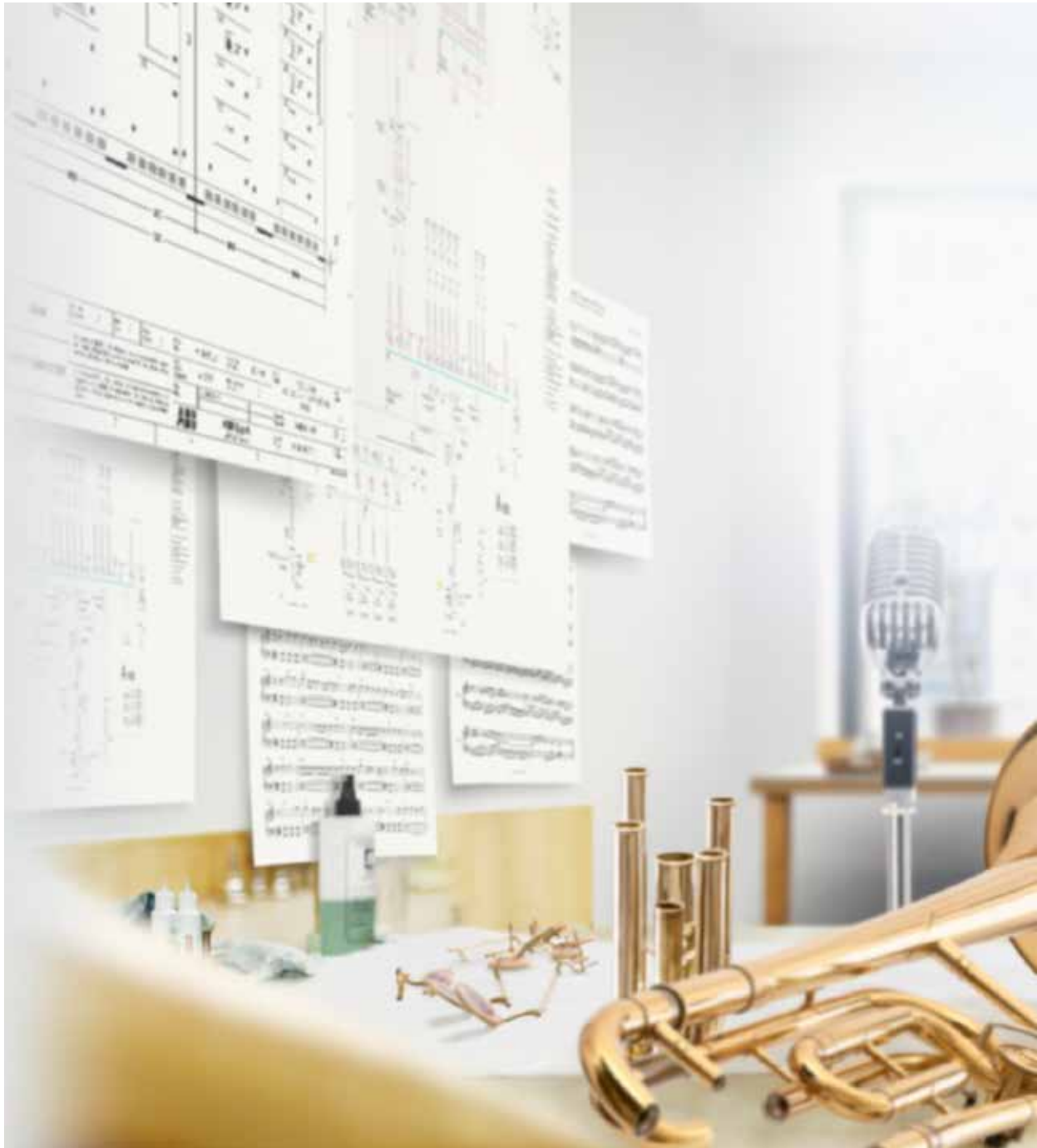

Discover more about SACE Tmax XT



Web page: go.abb/XT



Products conformity

SACE Tmax XT circuit-breakers and their accessories comply with IEC 60947, EN 60947 international Standards

Compliance with Standards

Tmax XT circuit-breakers and their accessories are constructed in compliance with:

- Standard:
 - IEC 60947-2;
- Directives:
 - EC “Low Voltage Directive” (LVD) N° 2014/35/EC;
 - EC “Electromagnetic Compatibility Directive” (EMC) 2014/30/EC;

Shipping Registers:

- Lloyd’s Register of Shipping, Germanischer Lloyd, Bureau Veritas, Rina, Det Norske Veritas, Russian Maritime Register of Shipping, ABS.

Certification of conformity with product Standards is carried out at the ABB SACE test laboratory (accredited by SINAL) in compliance with the EN 45011 European Standard, by the Italian certification body ACAE, member of the European LOVAG organization and by the Swedish certification body SEMKO recognized by the international IECCE organization.



CCC



JIS



KC



Registro Italiano Navale (RINA):
Italy



Lloyd’s Register of Shipping (LR):
United Kingdom



American Bureau Shipping (ABS):
United States of America



LOVAG low voltage agreement
group



Germanischer Lloyd (GL):
Germany



Bureau Veritas (BV):
France



Det Norske Veritas (DNV):
Norway



Russian Maritime Register of Shipping (RMRS):
Russia



Nippon Kaiji Kyokai (NKK):
Japan



Gost - Eac

For more information about circuit-breakers, certified ratings and their corresponding validity, please contact ABB SACE.



Company Quality System

The ABB SACE Quality System complies with the following Standards:

- ISO 9001 International Standard;
- EN ISO 9001 (equivalent) European Standards;
- UNI EN ISO 9001 (equivalent) Italian Standards;
- IRIS International Railway Industry Standards.

The ABB SACE Quality System attained its first certification by the RINA certification body in 1990.

Environmental Health & Safety Management System, Social Responsibility and Ethics

Special care for the environment is a priority commitment for ABB SACE. This is confirmed through the company's Environmental Management System which is certified by the RINA (ABB SACE was the first industry in the electromechanical sector in Italy to obtain this recognition) in conformity with the International ISO14001 Standard. In 1999 the Environmental Management System was integrated with the Occupational Health and Safety Management System according to the OHSAS 18001 Standard and later, in 2005, with the SA 8000 (Social Accountability 8000) Standard. All this amounts to solid evidence of ABB's commitment to respecting business ethics and promoting a safe and healthy working environment.

ISO 14001, OHSAS 18001 and SA8000 recognitions together with ISO 9001 made it possible to obtain RINA BEST⁴ (Business Excellence Sustainable Task) certification.

In addition to this, the following markings and certifications have been achieved :

- GISA 01.02A03;
- LCA (Life Cycle Assessment).

Product Material Compliance

The XT family complies with the following international regulations:

- RoHS II, Directive 2011/65/EC;
- China RoHS;
- REACH, 2006/1907/EC, Registration, Evaluation, Authorisation and Restriction of Chemicals;
- WEEE 2012/19/EU -Waste Electrical & Electronic Equipment;
- Conflict Minerals - Dodd-Frank Consumer Protection Act. Section 1502.



Construction characteristics

All the SACE Tmax XT molded case circuit-breakers are built in accordance with the following constructional characteristics.

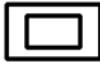

Double insulation

The Tmax XT circuit-breaker has double insulation between the live power parts (excluding the terminals) and the front parts of the apparatus where the operator works during normal operation. The seat of each electrical accessory is completely segregated from the power circuit, preventing any risk of contact with live parts. The operating mechanism especially is completely insulated from the powered circuits. Furthermore, the circuit-breaker has oversized insulation, both between the live internal parts and near the connection terminals. Furthermore, the distances exceed those required by the IEC Standards and fully comply with the prescriptions of the UL 489 Standard.



Positive operation

The operating lever always indicates the precise position of the moving contacts of the circuit-breaker, thereby guaranteeing safe and reliable signals, in compliance with IEC 60073 and IEC 60417-2 Standards (I = Closed; O = Open; yellow-green line = open due to protection trip). The circuit-breaker operating mechanism has a free release regardless of the pressure on the lever and the speed of operation. Protection tripping automatically opens the moving contacts: to close them again, the operating mechanism must first be reset by pushing the operating lever from the intermediate position to the lowest open position.

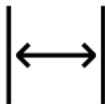

Insulation behaviour

In the open position, the circuit-breaker guarantees insulation distances in compliance with the IEC 60947-2 Standard, thus preventing leakage currents to flow between the input and output terminals.



Tropicalization

Circuit-breakers and accessories in the Tmax XT series are tested in compliance with the IEC 60068-2-30 Standard, carrying out 2 cycles at 55 °C with the "variant 1" method (clause 7.3.3).

The suitability of the Tmax XT series under the most severe environmental conditions is further ensured with the hot-humid climate according to climatograph 8 in the IEC 60721-2-1 Standards thanks to:

- molded insulating cases made of synthetic resins reinforced with glass fibers;
- anti-corrosion treatment of the main metallic parts;
- Fe/Zn 12 zinc-plating (ISO 2081) protected by a conversion layer, free from hexavalent chromium (ROHS-compliant), with the same corrosion resistance guaranteed by ISO 4520 class 2C;
- application of anti-condensation protection for electronic overcurrent releases and relative accessories.

The ranges

- 2/2 SACE Tmax XT automatic circuit-breakers for alternating current (AC) distribution**
- 2/6 SACE Tmax XT automatic circuit-breakers for direct current (DC) distribution**
- 2/10 SACE Tmax XT switch-disconnectors**

SACE Tmax XT automatic circuit-breakers for alternating current (AC) distribution



Size	XT1					
Rated uninterrupted current	[A]	160				
Poles	[No.]	3, 4				
Rated service voltage, Ue	(AC) 50-60Hz [V]	690				
Rated insulation voltage, Ui	[V]	800				
Rated impulse withstand voltage, Uimp	[kV]	8				
Versions	Fixed, Plug-in ⁽¹⁾					
Breaking capacities according to IEC 60947-2		B	C	N	S	H
Rated ultimate short-circuit breaking capacity, Icu						
Icu @ 220-230-240V 50-60Hz (AC)	[kA]	25	40	65	85	100
Icu @ 380V 50-60Hz (AC)	[kA]	18	25	36	50	70
Icu @ 415V 50-60Hz (AC)	[kA]	18	25	36	50	70
Icu @ 440V 50-60Hz (AC)	[kA]	15	25	36	50	65
Icu @ 500V 50-60Hz (AC)	[kA]	8	18	30	36	50
Icu @ 525V 50-60Hz (AC)	[kA]	6	8	22	35	35
Icu @ 690V 50-60Hz (AC)	[kA]	3	4	6	8	10
Rated service short-circuit breaking capacity, Ics						
Ics @ 220-230-240V 50-60Hz (AC)	[kA]	100%	100%	75% (50)	75%	75%
Ics @ 380V 50-60Hz (AC)	[kA]	100%	100%	100%	100%	75%
Ics @ 415V 50-60Hz (AC)	[kA]	100%	100%	100%	75%	50% (37.5)
Ics @ 440V 50-60Hz (AC)	[kA]	75%	50%	50%	50%	50%
Ics @ 500V 50-60Hz (AC)	[kA]	100%	50%	50%	50%	50%
Ics @ 525V 50-60Hz (AC)	[kA]	100%	100%	50%	50%	50%
Ics @ 690V 50-60Hz (AC)	[kA]	100%	100%	75% (5)	50% (5)	50%
Breaking capacities according to NEMA-AB1						
@ 240V 50-60Hz (AC)	[kA]	25	40	65	85	100
@ 480V 50-60Hz (AC)	[kA]	8	18	30	36	65
Utilization Category (IEC 60947-2)		A				
Icw	[kA]	-				
Reference Standard		IEC 60947-2				
Insulation behaviour		✓				
Mounted on DIN rail		DIN EN 50022				
Mechanical life	[No. Operations]	25,000				
	[No. Hourly operations]	240				
Electrical life @ 415 V (AC)	[No. Operations]	8,000				
	[No. Hourly operations]	120				
Dimensions						
Fixed	3 poles	[mm]	76.2 x 70 x 130			
(Width x Depth x Height)	4 poles	[mm]	101.6 x 70 x 130			
Trip units for power distribution						
TMD/TMA						
TMD/TFM						■
Ekip Dip						
Ekip Touch						
Trip units for motor protection						
MF/MA						
Ekip Dip						
Ekip Touch						
Trip units for generator protection						
TMG						
Ekip Dip						
Ekip Touch						
Interchangeable trip units						
Weight						
Fixed	3/4 poles	[kg]	1.1 / 1.4			
Plug in (EF terminals)	3/4 poles	[kg]	2.21 / 2.82			
Withdrawable (EF terminals)	3/4 poles	[kg]				

(1) XT1 plug-in In max=125A

(2) Ics=100% Icu up to 250 A with EF, ES and Rear terminal. When any other terminals are used and I1 >200A Icu=25%



XT2					XT3		XT4					
160					250		160 / 250					
3, 4					3, 4		3, 4					
690					690		690					
1000					800		1000					
8					8		8					
Fixed, Withdrawable, Plug-in					Fixed, Plug-in		Fixed, Withdrawable, Plug-in					
N	S	H	L	V	N	S	N	S	H	L	V	X
65	85	100	150	200	50	85	65	85	100	150	200	200
36	50	70	120	150	36	50	36	50	70	120	150	200
36	50	70	120	150	36	50	36	50	70	120	150	200
36	50	65	100	150	25	40	36	50	65	100	150	200
30	36	50	60	70	20	30	30	36	50	60	70	100
20	25	30	36	50	13	20	20	25	45	50	50	100
10	12	15	18	20	5	6	10	12	15	20	25	100
100%	100%	100%	100%	100%	75%	50%	100%	100%	100%	100%	100%	100%
100%	100%	100%	100%	100%	75%	50% (27)	100%	100%	100%	100%	100%	100%
100%	100%	100%	100%	100%	75%	50% (27)	100%	100%	100%	100%	100%	100%
100%	100%	100%	100%	100%	75%	50%	100%	100%	100%	100%	100%	100%
100%	100%	100%	100%	100%	75%	50%	100%	100%	100%	100%	100%	100%
100%	100%	100%	75% (15)	75%	75%	50%	100%	100%	100%	100%	100%	100% ⁽²⁾
65	85	100	150	200	50	85	65	85	100	150	200	200
30	36	65	100	150	25	35	30	36	65	100	150	100
A					A		A					
-					-		-					
IEC 60947-2					IEC 60947-2		IEC 60947-2					
✓					✓		✓					
DIN EN 50022					DIN EN 50022		DIN EN 50022					
25,000					25,000		25,000					
240					240		240					
8,000					8,000		8,000		10,000			
120					120		120					
90 x 82.5 x 130					105 x 70 x 150		105 x 82.5 x 160					
120 x 82.5 x 130					140 x 70 x 150		140 x 82.5 x 160					
■					■		■					
■					■		■					
■					■		■					
■					■		■					
■					■		■					
■					■		■					
■					■		■					
■					■		■					
■					■		■					
✓					✓		✓					
1.2 / 1.6					1.7 / 2.1		2.5 / 3.5					
2.54 / 3.27					3.24 / 4.1		4.19 / 5.52					
3.32 / 4.04							5 / 6.76					

SACE Tmax XT automatic circuit-breakers for alternating current (AC) distribution



Size		XT5					
Rated uninterrupted current	[A]	400 / 630					
Poles	[No.]	3, 4					
Rated service voltage, U _e	(AC) 50-60Hz [V]	690					
Rated insulation voltage, U _i	[V]	1000					
Rated impulse withstand voltage, U _{imp}	[kV]	8					
Versions		Fixed, Withdrawable, Plug-in ⁽⁵⁾					
Breaking capacities according to IEC 60947-2		N	S	H	L	V	X
Rated ultimate short-circuit breaking capacity, I_{cu}							
I _{cu} @ 220-230-240V 50-60Hz (AC)	[kA]	70	85	100	150	200	200
I _{cu} @ 380V 50-60Hz (AC)	[kA]	36	50	70	120	200	200
I _{cu} @ 415V 50-60Hz (AC)	[kA]	36	50	70	120	200	200
I _{cu} @ 440V 50-60Hz (AC)	[kA]	36	50	65	100	180	200
I _{cu} @ 500V 50-60Hz (AC)	[kA]	25	30	50	85	150	150
I _{cu} @ 525V 50-60Hz (AC)	[kA]	25	30	50	85	100	120
I _{cu} @ 690V 50-60Hz (AC)	[kA]	20	25	40	70	80	100
Rated service short-circuit breaking capacity, I_{cs}							
I _{cs} @ 220-230-240V 50-60Hz (AC)	[kA]	100%	100%	100%	100%	100%	100%
I _{cs} @ 380V 50-60Hz (AC)	[kA]	100%	100%	100%	100%	100%	100%
I _{cs} @ 415V 50-60Hz (AC)	[kA]	100%	100%	100%	100%	100%	100%
I _{cs} @ 440V 50-60Hz (AC)	[kA]	100%	100%	100%	100%	100%	100%
I _{cs} @ 500V 50-60Hz (AC)	[kA]	100%	100%	100%	100%	100%	100%
I _{cs} @ 525V 50-60Hz (AC)	[kA]	100%	100%	100%	100%	100%	100%
I _{cs} @ 690V 50-60Hz (AC)	[kA]	100%	100%	100% ⁽²⁾	100% ⁽³⁾	100% ⁽³⁾	100% ⁽³⁾
Breaking capacities according to NEMA-AB1							
@ 240V 50-60Hz (AC)	[kA]						
@ 480V 50-60Hz (AC)	[kA]						
Utilization Category (IEC 60947-2)		A (up to 630A), B (up to 500A) ⁽⁴⁾					
I _{cw} (1 sec)	[kA]	6					
Reference Standard		IEC 60947-2					
Insulation behaviour		✓					
Mounted on DIN rail		-					
Mechanical life	[No. operations]	20,000					
	[No. hourly operations]	240					
Electrical life @ 415 V (AC)	[No. operations]	7.000 (400A) - 5.000 (630A)					
	[No. hourly operations]	120					
Dimensions							
Fixed	3 poles	[mm]	140 x 103 x 205				
(Width x Depth x Height)	4 poles	[mm]	186 x 103 x 205				
Trip units for power distribution							
TMD/TMA		■					
TMD/TMF		■					
Ekip Dip		■					
Ekip Touch		■					
Trip units for motor protection							
MF/MA		■					
Ekip Dip		■					
Ekip Touch		■					
Trip units for generator protection							
TMG		■					
Ekip Dip		■					
Ekip Touch		■					
Interchangeable trip units							
		✓					
Weight							
Fixed	3/4 poles	[kg]	3.25 / 4.15				
Plug in (EF terminals)	3/4 poles	[kg]	5.15 / 6.65				
Withdrawable (EF terminals)	3/4 poles	[kg]	5.4 / 6.9				

(1) Not suitable for IT distribution Systems

(2) I_{cs} = 75% I_n > 500A(3) I_{cs} = 50% I_n > 500A

(4) Category B: only when equipped with an electronic trip unit

(5) Plug-in and Withdrawable: max I_n at 40°C=600A



XT6⁽⁴⁾			XT7			XT7 M		
800 / 1000 (only F)			800 / 1000 / 1250 / 1600			800 / 1000 / 1250 / 1600		
3, 4			3, 4			3, 4		
690			690			690		
1000			1000			1000		
8			8			8		
Fixed, Withdrawable			Fixed, Withdrawable			Fixed, Withdrawable		
N	S	H	S	H	L	S	H	L
70	85	100	85	100	200	85	100	200
36	50	70	50	70	120	50	70	120
36	50	70	50	70	120	50	70	120
30	45	50	50	65	100	50	65	100
25	35	50	45	50	85	45	50	85
25	35	50	45	50	65	45	50	65
20	22	25	30	42	50	30	42	50
100%	100%	100%	100%	100%	100%	100%	100%	100%
100%	100%	100%	100%	100%	100%	100%	100%	100%
100%	100%	100%	100%	100%	100%	100%	100%	100%
100%	100%	100%	100%	100%	100%	100%	100%	100%
100%	100%	100%	100%	100%	100%	100%	100%	100%
100%	100%	100%	100%	100%	100%	100%	100%	100%
100%	100%	100%	100%	100%	100%	100%	100%	100%
A (up to 1000A) - B (800A) ⁽⁴⁾			B			B		
10			20			20		
IEC 60947-2			IEC 60947-2			IEC 60947-2		
✓			✓			✓		
-			-			-		
20,000			10,000			20,000		
240			240			240		
5,000			3,000			3,000		
120			120			120		
210 x 103.5 x 268			210 x 166 x 268			210 x 178 x 268		
280 x 103.5 x 268			280 x 166 x 268			280 x 178 x 268		
■								
■			■			■		
			■			■		
■			■			■		
			■			■		
■			■			■		
			■			■		
✓			✓			✓		
9.5 / 12			9.7 / 12.5			11 / 14		
12.1 / 15.1			29.7 / 39.6			32 / 42.6		

SACE Tmax XT automatic circuit-breakers for direct current (DC) distribution



Size		XT1				
Rated uninterrupted current	[A]	160				
Poles	[No.]	3, 4				
Rated service voltage, U_e	(DC) [V]	500				
Rated insulation voltage, U_i	(DC) [V]	800				
Rated impulse withstand voltage, U_{imp}	[kV]	8				
Versions		Fixed, Plug-in ⁽²⁾				
Breaking capacities according to IEC 60947-2		B	C	N	S	H
Rated ultimate short-circuit breaking capacity, I_{cu}						
I _{cu} @ 250V (DC) 2-pole in series	[kA]	18	25	36	50	70
I _{cu} @ 500V (DC) 2-pole in series	[kA]	–	–	–	–	–
I _{cu} @ 500V (DC) 3-pole in series ⁽¹⁾	[kA]	18	25	36	50	70
I _{cu} @ 750V (DC) 3-pole in series	[kA]	–	–	–	–	–
Rated service short-circuit breaking capacity, I_{cs}						
I _{cs} @ 250V (DC) 2-pole in series	[kA]	100%	100%	100%	100%	75%
I _{cs} @ 500V (DC) 2-pole in series	[kA]	–	–	–	–	–
I _{cs} @ 500V (DC) 3-pole in series ⁽¹⁾	[kA]	100%	100%	100%	100%	75%
I _{cs} @ 750V (DC) 3-pole in series ⁽¹⁾	[kA]	–	–	–	–	–
Utilization Category (IEC 60947-2)		A				
Reference Standard		IEC 60947-2				
Insulation behaviour		✓				
Mounted on DIN rail		DIN EN 50022				
Mechanical life	[No. Operations]	25,000				
	[No. Hourly operations]	240				
Dimensions						
Fixed	3 poles	[mm]	76.2 x 70 x 130			
(Width x Depth x Height)	4 poles	[mm]	101.6 x 70 x 130			
Trip units for power distribution						
TMD/TMA						
TMD/TMF						■
Trip units with low magnetic (TMG)						
TMG						
Interchangeable trip units						
Weight						
Fixed	3/4 poles	[kg]	1.1 / 1.4			
Plug in (EF terminals)	3/4 poles	[kg]	2.21 / 2.82			
Withdrawable (EF terminals)	3/4 poles	[kg]				

(1) XT1: a 4 poles in series connection is required to be used in 500 V DC installations.

(2) XT1 plug-in In max=125A



Fixed, Withdrawable, Plug-in					Fixed, Plug-in		
N	S	H	L	V	N	S	
36	50	70	85	100	36	50	
-	-	-	-	-	-	-	
36	50	70	85	100	36	50	
-	-	-	-	-	-	-	
100%	100%	100%	100%	100%	100%	75%	
-	-	-	-	-	-	-	
100%	100%	100%	100%	100%	100%	75%	
-	-	-	-	-	-	-	
A					A		
IEC 60947-2					IEC 60947-2		
✓					✓		
DIN EN 50022					DIN EN 50022		
25,000					25,000		
240					240		
90 x 82.5 x 130					105 x 70 x 150		
120 x 82.5 x 130					140 x 70 x 150		
■					■		
■					■		
✓					■		
1.2 / 1.6					1.7 / 2.1		
2.54 / 3.27					3.24 / 4.1		
3.32 / 4.04							

SACE Tmax XT automatic circuit-breakers for direct current (DC) distribution



Size		XT4					
Rated uninterrupted current	[A]	160 / 250					
Poles	[No.]	3, 4					
Rated service voltage, Ue	(DC) [V]	750					
Rated insulation voltage, Ui	(DC) [V]	1000					
Rated impulse withstand voltage, Uimp	[kV]	8					
Versions		Fixed, Withdrawable, Plug-in					
Breaking capacities according to IEC 60947-2		N	S	H	L	V	X
Rated ultimate short-circuit breaking capacity, Icu							
Icu @ 250V (DC) 2 poles in series	[kA]	36	50	70	85	100	100
Icu @ 500V (DC) 2 poles in series	[kA]	36	50	70	85	100	100
Icu @ 500V (DC) 3 poles in series	[kA]	36	50	70	85	100	100
Icu @ 750V (DC) 3p in series	[kA]	-	-	-	-	-	70
Rated service short-circuit breaking capacity, Ics							
Ics @ 250V (DC) 2 poles in series	[kA]	100%	100%	100%	100%	100%	100%
Ics @ 500V (DC) 2 poles in series	[kA]	100%	100%	100%	100%	100%	100%
Ics @ 500V (DC) 3 poles in series	[kA]	100%	100%	100%	100%	100%	100%
Ics @ 750V (DC) 3 poles in series	[kA]	-	-	-	-	-	100%
Utilization Category (IEC 60947-2)		A					
Reference Standard		IEC 60947-2					
Insulation behaviour		✓					
Mounted on DIN rail		DIN EN 50022					
Mechanical life	[No. Operations]	25,000					
	[No. Hourly operations]	240					
Dimensions							
Fixed	3 poles	[mm]	105 x 82.5 x 160				
(Width x Depth x Height)	4 poles	[mm]	140 x 82.5 x 160				
Trip units							
TMD/TMA		■					
TMD/TMF							
Trip units with low magnetic (TMG)							
TMG							
Interchangeable trip units							✓
Weight							
Fixed	3/4 poles	[kg]	2.5 / 3.5				
Plug in (EF terminals)	3/4 poles	[kg]	4.19 / 5.52				
Withdrawable (EF terminals)	3/4 poles	[kg]	5 / 6.76				

(1) Power supply only from the top

(2) Ics=25% In>400A



Fixed, Withdrawable, Plug-in						Fixed, Withdrawable		
N	S	H	L	V	X	N	S	H
25	30	40	50	85	100	36	50	70
25	30	40	50	85	100	20	35	50
-	-	-	-	-	-	-	-	-
-	-	-	-	50 ⁽¹⁾	70 ⁽¹⁾	16	20	36
100% ⁽²⁾	100% ⁽²⁾	100% ⁽²⁾	100% ⁽²⁾	50%	50%	50%	50%	50%
100% ⁽²⁾	100% ⁽²⁾	100% ⁽²⁾	100% ⁽²⁾	50%	50%	50%	50%	50%
-	-	-	-	-	-	50%	50%	50%
-	-	-	-	50%	50%	50%	50%	50%
A						A		
IEC 60947-2						IEC 60947-2		
✓						✓		
-						-		
20,000						20,000		
240						240		
140 x 103 x 205						210 x 103.5 x 268		
186 x 103 x 205						280 x 103.5 x 268		
■						■		
■						■		
✓						✓		
3.25 / 4.15						9.5 / 12		
5.15 / 6.65						-		
5.4 / 6.9						12.1 / 15.1		

Protection

Each switch-disconnector must be protected on the supply side by a coordinated device which safeguards it against short-circuits.

The section "Coordination" in the table below shows the correspondence between each switch-disconnector and the relevant circuit-breaker.

Making capacity

The making capacity I_{cm} is highly important since a switch-disconnector must be able to withstand the dynamic, thermal and current stresses which can occur during closing operations without being destroyed, right up to short-circuit closing conditions.

XT5D		XT6D		XT7D		XT7D M	
400	630	630 - 800 - 1000		1000 - 1250 - 1600		1000 - 1250 - 1600	
3, 4	3, 4	3, 4		3, 4		3, 4	
Fixed, Plug-in, Withdrawable		Fixed, Withdrawable ⁽¹⁾		Fixed, Withdrawable		Fixed, Withdrawable	
690	690	690		690		690	
750	750	750		750		750	
800	800	1,000		1,000		1,000	
8	8	8		8		8	
7,65	12,3	30		40		40	
440	440	220		252		252	
5	7,6	15		20		20	
400		630		630 - 800 - 1000		1000 - 1250 - 1600	
400		630		630 - 800		1000 - 1250 - 1600	
400		630		630 - 800 - 1000		1000 - 1250 - 1600	
400		630		630 - 800		1000 - 1250 - 1600	
400 2p in series		630 2p in series		630 - 800 - 1000 - 2p in series		1000 - 1250 - 1600 - 2p in series	
400 2p in series		630 2p in series		630 - 800 - 2p in series		1000 - 1250 - 1600 - 2p in series	
400 2p in series		630 2p in series		630 - 800 - 1000 - 2p in series		1000 - 1250 - 1600 - 3p in series	
400 2p in series		630 2p in series		630 - 800 - 2p in series		1000 - 1250 - 3p in series	
400 3p in series		630 3p in series		630 - 800 - 1000 - 3p in serie		1000 - 1250 - 1600 - 4 p in series	
400 3p in series		630 3p in series		630 - 800 - 3p in serie		1000 - 1250 - 4 p in series	
5,000		3,000		3,500		2,500	
20,000		20,000		20,000		20,000	

XT5 630					XT6800			XT6 1000			XT7 1000			XT7 1200			XT71600			XT7 M 1000			XT7 M 1200			XT7 M 1600					
N	S	H	L	V	N	S	H	N	S	H	S	H	L	S	H	L	S	H	L	S	H	L	S	H	L	S	H	L			
36	50	70	120	200	36	50	70	36	50	70	50	70	120	50	70	120	50	70	120	50	70	120	50	70	120	50	70	120	50	70	120
-	-	-	-	-	-	-	-	-	-	-	-	-	-	-	-	-	-	-	-	-	-	-	-	-	-	-	-	-	-	-	-
-	-	-	-	-	-	-	-	-	-	-	-	-	-	-	-	-	-	-	-	-	-	-	-	-	-	-	-	-	-	-	-
-	-	-	-	-	-	-	-	-	-	-	-	-	-	-	-	-	-	-	-	-	-	-	-	-	-	-	-	-	-	-	-
36	50	70	120	200	-	-	-	-	-	-	-	-	-	-	-	-	-	-	-	-	-	-	-	-	-	-	-	-	-	-	-
36	50	70	-	-	-	-	-	-	-	-	-	-	-	-	-	-	-	-	-	-	-	-	-	-	-	-	-	-	-	-	-
-	-	-	-	-	36	50	70	-	-	-	-	-	-	-	-	-	-	-	-	-	-	-	-	-	-	-	-	-	-	-	-
-	-	-	-	-	-	-	-	36	50	70	-	-	-	-	-	-	-	-	-	-	-	-	-	-	-	-	-	-	-	-	-
-	-	-	-	-	-	-	-	-	-	-	50	70	120	-	-	-	-	-	-	50	70	120	-	-	-	-	-	-	-	-	-
-	-	-	-	-	-	-	-	-	-	-	-	-	-	50	70	120	-	-	-	-	-	-	50	70	120	-	-	-	-	-	-
-	-	-	-	-	-	-	-	-	-	-	-	-	-	-	-	-	50	70	120	-	-	-	-	-	-	50	70	120	-	-	-

Protection trip units

3/2	Introduction
3/4	New digital experience
3/14	Offer
	Thermal-magnetic trip unit
3/18	Overview
3/20	Protection settings
	Ekip Dip
3/22	Overview
3/24	Protection settings
3/26	Tolerances
	Ekip Touch/Hi-Touch
3/28	Overview
3/34	Protection functions
3/48	Additional functions
3/50	Protection settings
3/54	Tolerances
3/56	Measurement functions and data

Introduction

SACE Tmax XT trip units break new ground: they represent a new benchmark for the molded case circuit-breakers as they are able to satisfy any performance requirement.

The Tmax XT trip units are designed to be used in a wide range of applications. This complete, flexible protection trip unit can be adapted to the actual level of protection required, independently of the complexity of the system.

The range is available for three levels of performances, to meet any requirement, from simple to advanced applications.

- **TM, thermal-magnetic trip unit**
- **Ekip Dip, electronic trip unit**
- **Ekip Touch/Hi-Touch, electronic trip units**





Thermal-magnetic trip units

Used in both AC and DC networks, these are a solution for protection against overloads and short-circuits. Overload protection is ensured thanks to ABB thermal device based on a temperature dependent bimetal heated by the current. Protection against short-circuiting is realized with a magnetic device.

The Ekip Dip trip units

The first level of electronic trip units, used for the protection of AC network: these are based on microprocessor technologies and guarantee high reliability and tripping precision. They provide protection against overloads, selective short-circuits, short-circuits and earth faults. The power required for their operation is provided directly from the current sensors.

The Ekip Touch/Hi-Touch trip units

These represent the state of the art in terms of technology for AC network protection with advanced protection and system management functions. Diverse communication protocols enable the reading of measurement parameters and circuit-breaker control remotely. Class 1 active energy measurement in compliance with the IEC 61557-12 Standard permits highly demanding requirements of energy efficiency to be satisfied. The integrated display makes interaction with the Ekip Touch an easy and intuitive experience for the user and the embedded Bluetooth functionality allows fast interaction via EPiC (Electrification products intuitive Configurator). The Ekip Touch trip unit guarantees maximum flexibility. In fact, by selecting among the numerous software solutions available, it is possible to customize the functionality of the device at will. On the other side, the Ekip Hi-Touch trip unit includes all functions by default, representing the top-of-the-line in the SACE Tmax XT offer.

New digital experience

With the new Ekip Touch and Hi-Touch trip units, it is always possible to select and install the desired functions on the device. The functions can be selected when ordering the circuit-breaker or downloaded directly from the ABB Ability Marketplace™, even from a smart phone or tablet, thus reducing installation time to zero.

New digital experience

Ekip Touch/Hi-Touch trip units can be now customized with the functions required.

Ekip Touch/Hi-Touch always allow the user to enter in a new product experience thanks to the possibility to build up his own tailor-made trip unit by selecting the set of protections, measurements and logics.

Circuit-breakers' customization has never been so easy.

With the new Ekip Touch and Hi-Touch trip units, the most advanced functionalities can be enabled following two different purchasing processes:

- **1 ABB Ability Marketplace™**

Users can download digital upgrades via web and enable them directly on the trip unit, without removing the circuit-breaker from the installation point, with zero shipping time and no installation costs. This process allows additional functions to be selected after the trip unit has been already received on site and installed. Moreover, stock can be optimized by keeping in the warehouse few types of trip units and customizing them according to the customer's specific needs. Once purchased, each function can be easily activated by using a smartphone or tablet via EPiC and embedded Bluetooth connectivity, or a laptop with Ekip Connect 3 and an Ekip T&P.

- **2 Traditional ordering**

This option represents the standard way to order ABB devices. The traditional process allows the users to select and directly install the desired functions when ordering the circuit-breaker. Once received and installed, SACE Tmax XT always offers the possibility to add new functionalities via ABB Ability Marketplace™.

The new Ekip digital offering includes:

- **Packages**

The software packages offer the possibility to customize the circuit-breaker by selecting additional protection functions and measurements. The device can be personalized to create tailor-made solutions according to the specific application. Maximum flexibility is guaranteed by offering specific technical features that can be combined in the Ekip Touch/Hi-Touch during the product life cycle.

- **Bundles**

Simplify the selection of advanced functions and logics with group of packages able to satisfy requirements by market segments and applications.

Bundles shall require additional plug and play hardware modules.

- **Solutions**

The SACE Tmax XT circuit-breaker is no more intended as a simply stand-alone protection device, but it has become an active player in the electrical system, able to exchange data and trigger actions managing the behavior of other connected devices. Thanks to the new electronic trip units, it is possible to implement transfer logics, load shedding and peak shaving strategies. Such solutions require additional plug and play hardware modules and other smart devices.

SACE Tmax XT allows to easily upgrade and customize the Ekip Touch and Hi-Touch trip units, guaranteeing maximum flexibility for any application, delivering value throughout the entire customer journey.

1. Design



Build the circuit-breaker according to specific project requirements.

Key drivers

- Ease of doing business
- Technical specifications
- Application and function

Benefits

- Flexibility of choice
- Customization by application

2. Commissioning



Customize the device thanks to the digital offering. Manage last minute changes through digital upgrades.

Key drivers

- Ease of doing business
- Management of components
- Time to market

Benefits

- Stock optimization
- Zero lead time and installation effort

3. Service



Unlock the full potential of your circuit-breaker at any time, minimizing downtime and installation changes.

Key drivers

- Manage installed base
- Simplify diagnostics
- Simplify the hardware re-design

Benefits

- Zero lead time and installation effort
- Avoid downtime

New digital experience

Packages

Each package includes a set of protection functions or measurements that can be enabled in the trip unit.

Six packages relate to protection functions: Voltage Protections, Frequency Protections, Power Protections, Advanced Voltage Protections, RO-COF Protections and Adaptive Protections.



Voltage Protections

Set of protections included: UV - Undervoltage, OV - Overvoltage, UV2 - 2nd Undervoltage, OV2 - 2nd Overvoltage, PS - Phase Sequence, VU - Voltage unbalance.

How to order: via ABB Ability Marketplace™ or traditional ordering channels.

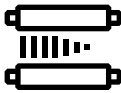

Frequency Protections

Set of protections included: UF - Underfrequency, OF - Overfrequency, UF2 - 2nd Underfrequency, OF2 - 2nd Overfrequency.

How to order: via ABB Ability Marketplace™ or traditional ordering channels.



Power Protections

Set of protections included: RP - Reverse active power, Cos Φ - Power factor, D - Directional overcurrent, RQ - Loss of field or reverse reactive power, OQ - Reactive overpower, OP - Active overpower, UP - Active underpower, RQ - 2nd Loss of field or Reverse reactive power.

How to order: via ABB Ability Marketplace™ or traditional ordering channels.



Advanced Voltage Protections

Set of protections included: S(V) - Voltage controlled overcurrent, S(V)2 - 2nd Voltage controlled overcurrent, R - Residual voltage.

How to order: via ABB Ability Marketplace™ or traditional ordering channels.

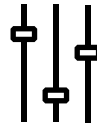

ROCOF Protections

Set of protections included: ROCOF - Rate of change of frequency.

How to order: via ABB Ability Marketplace™ or traditional ordering channels.



Adaptive Protections

Set of protections included: Dual Setting - Set A-B.

How to order: via ABB Ability Marketplace™ or traditional ordering channels.



Measuring Package

To monitor the plant through several measurements: Phase-to-phase voltage, Phase-to-neutral voltage, Phase sequence, Frequency, Active power, Reactive power, Apparent power, Power factor, Peak factor.

How to order: via ABB Ability Marketplace™ or traditional ordering channels.

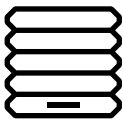

Data Logger

To record data about events in the plant: Currents, Voltages, Sampling rate, Maximum recording duration, Recording stop delay, Number of registers.

How to order: via ABB Ability Marketplace™ or traditional ordering channels.

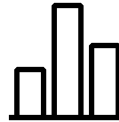

Network Analyzer

To monitor the power quality of the network through: Harmonic analysis, Hourly average voltage value, Short voltage interruption, Short voltage spikes, Slow-voltage sags and swells, Voltage unbalance.

How to order: via ABB Ability Marketplace™ or traditional ordering channels.













When a package is purchased via ABB Ability Marketplace™, it must be activated through:

- Ekip Connect 3 installed on a PC using Ekip T&P to scan the trip unit
- EPiC installed on a mobile device, by directly using the embedded Bluetooth connection available in the new Ekip trip units.

New digital experience Packages

Thanks to the maximum flexibility guaranteed by these packages, the new Ekip trip units are now completely customizable. Depending on the specific trip unit version, different packages are available by default, but all of them can be added to the trip unit.









Default functionalities and upgradability of the trip units:

												
	Standard Protection	Standard Measures	Measuring Package	Voltage Protections	Frequency Protections	Power Protections	Adaptive Protections	Adaptive Protections	Network Analyzer	Advanced Voltage Protections	ROCOF Protections	Power Controller
Ekip Touch	●	●	↑	↑	↑	↑	↑	↑	↑	↑	↑	↑
Ekip Touch Measuring	●	●	●	↑	↑	↑	↑	↑	↑	↑	↑	↑
Ekip G Touch	●	●	●	↑	↑	↑	↑	●	↑	↑	↑	↑
Ekip M Touch	●	●	●	●	●	↑	●	↑	↑	↑	↑	↑
Ekip Hi-Touch	●	●	●	●	●	↑	●	●	●	↑	↑	↑
Ekip G Hi-Touch	●	●	●	●	●	●	●	●	●	●	●	↑

● Available by default
 ↑ Updraggable
 ↑ Some functions available. Updraggable with the full package.

The flexibility offered by the packages allows also the selection of the proper functions that can be required by the different segments and applications, purchasing only the needed functionalities.

Suggested packages by segment:

Packages									
	Wind	Solar	Data Center	Building Infrastructure	GenSet	Mining	Marine	Industries	Utilities
Voltage Protections	●	●		●	●		●		
Advanced Voltage Protections	●	●			●				
Frequency Protections	●	●			●	●		●	●
Power Protections			●	●		●		●	●
ROCOF Protections	●	●			●				
Adaptive Protections	●	●		●		●			
Measuring Package	●	●	●	●	●	●	●	●	●
Data Logger	●	●	●	●	●		●	●	
Network Analyzer	●	●	●	●	●	●	●		●
Power Controller			●	●		●			●

New digital experience

Bundles

Each bundle includes a set of packages that can be enabled on the trip unit. Five bundles are available to satisfy different needs: Intelligent Grid Edge, Power Management, Grid Connection, Diagnostics and Measure Advanced.

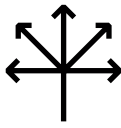

Intelligent Grid Edge

Make your grid smart.

Thanks to this bundle, the circuit-breaker becomes the main player of the smart interconnection of power distribution and loads for demand-supply coordination. Packages included: Measuring Package, Adaptive Protections, Power Protections, Voltage Protections and Ekip Power Controller.

How to order: via ABB Ability Marketplace™ or traditional ordering channels.

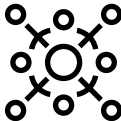

Power Management

Embedded demand management.

Thanks to this bundle, the circuit-breaker is ready for demand management to ensure service continuity and reduce energy costs. Packages included: Measuring Package, Adaptive Protections, Power Protections and Voltage Protections. How to order: via ABB Ability Marketplace™ or traditional ordering channels.

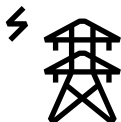

Grid Connection

Optimize renewable power generation.

No more external and additional relays are needed with this bundle. It enhances tracking and improved energy harvesting. Packages included: Measuring Package, Adaptive Protections, Power Protections and Ekip Power Controller.

How to order: via ABB Ability Marketplace™ or traditional ordering channels.



Diagnostics

Comprehensive data for root-cause analysis and preventive maintenance.

This bundle gives full diagnostics of the system to guarantee a full control of the plant status.

Packages included: Measuring Package, Network Analyzer and Data Logger.

How to order: via ABB Ability Marketplace™ or traditional ordering channels.

Available for Tmax XT5 and XT7 only.

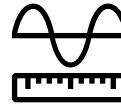

Measure Advanced

Embedded advanced metering and power quality information.

This bundle gives the possibility to preserve the loads, by avoiding equipment malfunctioning and optimizing energy consumption thanks to additional measurements and full power quality analysis. Packages included: Measuring Package, Network Analyzer.

How to order: via ABB Ability Marketplace™ or traditional ordering channels.

Available for Tmax XT5 and XT7 only.

When a bundle is purchased via ABB Ability Marketplace™, it must be activated through:









- Ekip Connect 3 installed on a PC using Ekip T&P to scan the trip unit
- EPiC installed on a mobile device, by directly using the embedded Bluetooth connection available in the new Ekip trip units.

New digital experience

Bundles

The flexibility offered by the bundles allows also the selection of the proper functions that can be required by different segments and applications, purchasing only the needed functionalities.

Suggested bundles by segment:

Bundle	 Wind	 Solar	 Data Center	 Building Infrastructure	 GenSet	 Mining	 Marine	 Industries	 Utilities
Intelligent Grid Edge			●	●	●				●
Power Management			●	●				●	●
Grid Connection	●	●						●	
Diagnostics	●	●	●	●	●	●	●		
Measure Advanced	●	●	●	●	●	●			

New digital experience

Solutions

Five solutions are available to fully exploit the potential of the Ekip architecture: Interface Protection System, Synchro Reclosing, Embedded ATS, Adaptive Load Shedding and Ekip Power Controller.

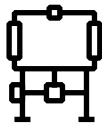

Interface Protection System

This solution is used to disconnect the generating units from the grid when voltage and frequency values are out of the ranges prescribed by the Standard. This disconnection is usually carried out through an Interface Device and an Interface Protection System. Thanks to the Ekip Touch/Hi-Touch trip units, this function is integrated in one single circuit-breaker.

How to order: via ABB Ability Marketplace™ or traditional ordering channels.

The hardware accessories must be ordered via traditional ordering channels.



Synchro Reclosing

Thanks to the Synchro Reclosing solution, the circuit-breaker is able to island the Microgrid in case of disturbances due to faults or power quality events, and reconnect it to the distribution network when the proper conditions are guaranteed again. This last feature allows an islanded microgrid to be reconnected to the main grid, after the synchronism for automatic re-closure has been verified.

How to order: via ABB Ability Marketplace™ or traditional ordering channels.

The hardware accessories must be ordered via traditional ordering channels.

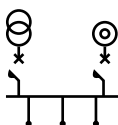

Embedded ATS

This function enables the activation of auxiliary generation sources (e.g. generators) and transfers the feed of the loads from the distribution

network to such auxiliary sources, thus ensuring a secure transfer to maintain service continuity and reliability of the system.

How to order: via ABB Ability Marketplace™ or traditional ordering channels.

The hardware accessories must be ordered via traditional ordering channels.

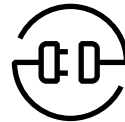

Adaptive Load Shedding

Thanks to this solution, the circuit-breaker enables islanding transition to avoid blackouts.

It actively controls the power consumption based on the priorities set by the user.

How to order: via ABB Ability Marketplace™ or traditional ordering channels.

The hardware accessories must be ordered via traditional ordering channels.



Ekip Power Controller

This function is the ideal solution for load management and represents an optimum compromise between reliability, simplicity and cost-effectiveness. Based on a patented calculation algorithm, Ekip Power Controller allows a list of loads to be controlled from remote according to the priorities defined by the user.

How to order: via ABB Ability Marketplace™ or traditional ordering channels. The hardware accessories must be ordered via traditional ordering channels.

When a solution is purchased via ABB Ability Marketplace™, it must be activated through Ekip Connect 3 installed on a PC using Ekip T&P to scan the trip unit.

These solutions require the installation of hardware components that have to be ordered through the traditional ordering channels. For further information, please refer to the specific documentation available on ABB Library (www.abb.com/abblibrary/DownloadCenter/).

New digital experience

Solutions

	Functions included	Hardware accessories
PACKAGES		
Voltage Protections	UV - Undervoltage OV - Overvoltage UV2 – 2nd Undervoltage OV2 – 2nd Overvoltage PS – Phase sequence VU – Voltage unbalance	-
Frequency Protections	UF - Underfrequency OF - Overfrequency UF2 – 2nd Underfrequency OF2 - 2nd Overfrequency	-
Power Protections	RP – Reverse active power Cos Φ - Power factor D – Directional current RQ – Loss of field or Reverse reactive power OQ – Reactive overpower OP – Active overpower UP – Active underpower 2RQ – 2nd Loss of field or Reverse reactive power	-
Advanced Voltage Protections	S(V) – Voltage controlled overcurrent S(V)2 – 2nd Voltage controlled overcurrent R – Residual voltage	-
ROCOF Protections	ROCOF	-
Adaptive Protections	Dual setting	Ekip Signalling
Measuring Package	Phase-to-phase voltage Phase-to-neutral voltage Phase sequence Frequency Active power Reactive power Apparent power Power factor Peak factor	-
Data Logger	Currents Voltages Sampling rate Maximum recording duration Recording stop delay Number of registers	-
Network Analyzer	Hourly average voltage value Short voltage interruptions Short voltage spikes Slow voltage sags and swells Voltage unbalance Harmonic analysis	-

	Functions included	Hardware accessories
BUNDLES		
Intelligent Grid Edge	Measuring Package	Ekip Link, Ekip Signalling, motor operators and coils
	Adaptive Protections	
	Power Protections	
	Voltage Protections	
	Ekip Power Controller	
Power Management	Measuring Package	Ekip Signalling
	Adaptive Protections	
	Power Protections	
	Voltage Protections	
Grid Connection	Measuring Package	Ekip Link, Ekip Signalling, motor operators and coils
	Adaptive Protections	
	Power Protections	
	Ekip Power Controller	
Diagnostics	Measuring Package	-
	Network Analyzer	
	Data Logger	
Measure Advanced	Measuring Package	-
	Network Analyzer	
SOLUTIONS		
Interface Protection System	-	Ekip Link, Ekip Signalling, motor operators and coils
Synchro Reclosing	-	Ekip Link, Ekip Signalling, motor operators and coils
Embedded ATS	-	Ekip Link, Ekip Signalling, motor operators and coils
Adaptive Load Shedding	-	Ekip Link, Ekip Signalling, motor operators and coils
Ekip Power Controller	-	Ekip Link, Ekip Signalling, motor operators and coils

Offer

SACE Tmax XT trip units offer a solution for any installation requirement, from the building sector to industry, from marine purposes to datacenters any need is always satisfied.

The complete, flexible protection trip unit is classified in three different fields of applications as follows:

Power distribution protection

Tmax XT is the ideal solution for all distribution levels, from main low voltage switchboards to sub-switchboards, and also for transformers and drives. The field of application is very broad and ranges from residential and commercial buildings, infrastructure, microgrids, but also industrial environments, oil and gas installations, mining facilities, data centers, marine applications, wind and solar farms. Depending on the complexity of the system, it is possible to select between different performance levels. Thus, when higher protection accuracy is required, or advanced control systems are needed, it is always possible to choose the appropriate version.

Motor protection

Motors are used in several industrial sectors, like food and beverage, chemicals, metallurgic, paper, water and extractive industries. When a motor system needs to be protected, the safety and reliability of the solution are important aspects that must be considered when choosing and manufacturing the system for motor starting and monitoring.

Start-up is a particularly critical phase for the motor itself and for the system powering it. When it comes to direct starting, the SACE Tmax XT range proposes different solutions, from magnetic only protection to a very advanced protection system.

Generator protection

Tmax XT has been designed to provide a solution for the protection of small generators and networks where distribution is realized through very long cables. In addition, it also provides protection for generators without using external devices that require dedicated relays and wiring. This solution minimizes the time needed for implementation and commissioning of the system, and ensures the high levels of accuracy and reliability required for running generators in applications such as naval, GenSet or cogeneration.

	Field of application	Current protection	Remote Control	Measurement and protection of current, frequency, voltage power, energy	Embedded software functions
TMD/TMA	Power Distribution	●	●		
Ekip Dip		●	●		
Ekip Touch		●	●	●	●
MA	Motor	●	●		
Ekip M Dip		●	●		
Ekip M Touch		●	●	●	●
TMG	Generator	●	●		
Ekip G Dip		●	●		
Ekip G Touch		●	●	●	●





Offer

The Tmax XT trip units represent the ideal solution for any application up to 1600A.

The Tmax XT molded case circuit-breaker family complies with numerous installation requirements. Circuit-breakers are available with trip units dedicated to three different application groups. The table below shows the trip units for each circuit-breaker frame and the related rated interrupted current ranges.

The power distribution and generator protection application trip units are available in both 3 and 4-pole versions. With the XT2, XT4, XT5, XT6, XT7 and XT7 M versions the trip units are interchangeable, in order to make a performance upgrade of the system easier.



Rated uninterrupted current ranges [A]	XT1	XT2	XT3
Power Distribution Protection			
Thermal-magnetic			
TMD	16...160 ⁽¹⁾	1,6...32	63...250
TMA		40...160	
Ekip Dip			
Ekip Dip LS/I		10...160	
Ekip Dip LIG		10...160	
Ekip Dip LSI		10...160	
Ekip Dip LSIG		10...160	
Ekip Touch			
Ekip Touch LSI		40...160	
Ekip Touch LSIG		40...160	
Ekip Touch Measuring LSI		40...160	
Ekip Touch Measuring LSIG		40...160	
Ekip Hi-Touch LSI		40...160	
Ekip Hi-Touch LSIG		40...160	
Motor Protection			
Magnetic			
MF/MA	3.2...125	1...160	100...200
Ekip Dip			
Ekip M Dip I		10...160	
Ekip M Dip LIU		25...160	
Ekip Touch			
Ekip M Touch LRIU		40...100	
Generator Protection			
Thermal-magnetic			
TMG		16...160	63...250
Ekip Dip			
Ekip G Dip LS/I		10...160	
Ekip Touch			
Ekip G Touch LSIG			
Ekip G Hi-Touch LSIG			

1) 16A and 20A for N, S, H have the TMF trip unit

Maximum flexibility is guaranteed for customers: on the XT5, XT7 and XT7 M, with Ekip Touch trip units, the interchangeable rating plug enables the rated current to be changed according to system requirements.



XT4	XT5	XT6	XT7	XT7 M
16...32				
40...250	320...630	630		
40...250	250...630	630...1000	630...1600	630...1600
40...250	250...630	630...1000	630...1600	630...1600
40...250	250...630	630...1000	630...1600	630...1600
40...250	250...630	630...1000	630...1600	630...1600
100...250	250...630		630...1600	630...1600
100...250	250...630		630...1600	630...1600
100...250	250...630		630...1600	630...1600
100...250	250...630		630...1600	630...1600
100...250	250...630		630...1600	630...1600
100...250	250...630		630...1600	630...1600
10...200	320...500			
40...250	250...630	630...1000	630...1600	630...1600
40...160	250...500	630		
100...200	250...500		630...1600	630...1600
	320...630			
40...250	250...630	630...1000	630...1600	630...1600
	250...630		630...1600	630...1600
	250...630		630...1600	630...1600

Thermal-magnetic trip unit

Overview

The thermal-magnetic trip units are used for the protection of AC and DC networks. They are a solution for systems where only protection against overloads and short-circuits are needed.

Power Distribution Protection

- TMD
- TMA

Motor Protection

- MA

Generator Protection

- TMG

- Key:
1. Current threshold for short-circuit protection;
 2. Rotary switch for short-circuit protection;
 3. Current threshold for overload protection;
 4. Rotary switch for overload threshold setting.



Rotary switch

Depending on the version it is possible to set the desired thresholds for protection by turning the front rotary switch.

Field of application	Trip Unit	L - Overload Protection		I - Short-circuit Protection	
		Current Threshold	Trip Time	Current Threshold	Trip Time
Power Distribution Protection	TMD	Adjustable	Fixed	Fixed	Fixed instantaneous
	TMA	Adjustable	Fixed	Adjustable	Fixed instantaneous
Motor Protection	MA	-	-	Adjustable	Fixed instantaneous
Generator Protection	TMG	Adjustable	Fixed	Adjustable	Fixed instantaneous

Power Distribution Protection

TMD

In [A]	1.6	2	2.5	3.2	4	5	6.3	8	10	12.5	16	20	25	32	40	50	63	80	125	160	200	250
XT1											●	●	●	●	●	●	●	●	●	●		
XT2	●	●	●	●	●	●	●	●	●	●	●	●	●	●								
XT3																	●	●	●	●	●	●
XT4											●	●	●	●								

Note: the XT1 with In = 16A or 20A and with N, S and H breaking capacity have the TMF trip unit only

TMA

In [A]	40	50	63	80	100	125	160	200	225	250	320	400	500	630	800
XT2	●	●	●	●	●	●	●								
XT4	●	●	●	●	●	●	●	●	●	●					
XT5											●	●	●	●	
XT6															●

Motor Protection

MA

In [A]	1	2	3.2	4	6.3	8.5	10	12.5	16	20	32	52	63	80	100	125	160	200	320	400	500	630
XT1			●		●				●		●	●	●	●	●	●						
XT2	●	●		●	●		●		●	●	●		●	●	●		●					
XT3															●	●	●	●				
XT4							●	●		●	●	●		●	●	●	●	●				
XT5																			●	●	●	●

Note: the XT2 and XT4 up to 12.5A are available only as complete circuit-breakers
 the XT4 V and X versions up to 52A are available only as complete circuit-breakers with the Icu value at 690V AC = 5kA
 the XT2 up to 12.5A have the MF trip unit with fixed short-circuit protection

Generator Protection

TMG

In [A]	16	20	25	32	40	50	63	80	100	125	160	200	250	320	400	500	630
XT2	●	●	●	●	●	●	●	●	●	●	●						
XT3							●	●	●	●	●	●	●				
XT5														●	●	●	●

Note: the XT2 up to 63A are available only as complete circuit-breakers

Thermal-magnetic trip unit

Protection settings

Available settings for TMD and TMA trip units:

Circuit Breaker	Trip Unit	In [A]	L - Overload					I - Short-circuit						
			I1 [A]			Neutral [A]		I3 [A]			Neutral [A]			
			MIN	MED	MAX	100%	50%	MIN	MED	MAX	100%	50%		
XT1	TMD	16			16	16	-	450			450	-		
		20			20	20	-	450			450	-		
		25	17.5	21.25	25	25	-	450			450	-		
		32	22.4	27.2	32	32	-	450			450	-		
		40	28	34	40	40	-	450			450	-		
		50	35	42.5	50	50	-	500			500	-		
		63	44.1	53.55	63	63	-	630			630	-		
		80	56	68	80	80	-	800			800	-		
		100	70	85	100	100	-	1000			1000	-		
		125	87.5	106.25	125	125	80	1250			1250	800		
160	112	136	160	160	100	1600			1600	1000				
XT2	TMD	1.6	1.1	1.3	1.6	1.6	-	16			16			
		2	1.4	1.7	2	2	-	20			20			
		2.5	1.7	2.1	2.5	2.5	-	25			25			
		3.2	2.2	2.7	3.2	3.2	-	32			32			
		4	2.8	3.4	4	4	-	40			40			
		5	3.5	4.2	5	5	-	50			50			
		6.3	4.4	5.3	6.3	6.3	-	63			63			
		8	5.6	6.8	8	8	-	80			80			
		10	7	8.5	10	10	-	100			100			
		12.5	8.7	10.6	12.5	12.5	-	125			125			
		16	11 (11.2)	14 (13.6)	16	16	-	300			300			
		20	14	17	20	20	-	300			300			
		25	18 (17.5)	21 (21.2)	25	25	-	300			300			
	32	22 (22.4)	27 (27.2)	32	32	-	320			320				
	TMA	40	28	34	40	40	-	300	350 (360)	400	300...400	-		
		50	35	43 (42.5)	50	50	-	300	400	500	300...500	-		
		63	44 (44.1)	54 (53.5)	63	63	-	300	465	630	300...630	-		
		80	56	68	80	80	-	400	600	800	400...800	-		
		100	70	85	100	100	-	500	750	1000	500...1000	-		
		125	88 (87.5)	106 (106.2)	125	125	80	625	940	1250	625...1250	400...800		
160		112	136	160	160	100	800	1200	1600	800...1600	500...1000			
200		140	170	200	200	125	2000			2000	1250			
XT3	TMD	63	44.1	53.55	63	63	-	630			630	-		
		80	56	68	80	80	-	800			800	-		
		100	70	85	100	100	-	1000			1000	-		
		125	87.5	106.25	125	125	80	1250			1250	800		
		160	112	136	160	160	100	1600			1600	1000		
		200	140	170	200	200	125	2000			2000	1250		
		250	175	212.5	250	250	160	2500			2500	1600		
		XT4	TMD	16	11	14 (13.6)	16	16	-	300			300	-
				20	14	17	20	20	-	300			300	-
				25	18 (17.5)	21 (21.2)	25	25	-	300			300	-
32	22 (22.4)			27 (27.2)	32	32	-	320			320	-		
TMA	40			28	34	40	40	-	300	350	400	300...400	-	
	50		35	43 (42.5)	50	50	-	300	400	500	300...500	-		
	63		44 (44.1)	54 (53.5)	63	63	-	315	473 (472.5)	630	315...630	-		
	80		56	68	80	80	-	400	600	800	400...800	-		
	100		70	85	100	100	-	500	750	1000	500...1000	-		
125	88 (87.5)		106 (106.2)	125	125	80	625	938 (937.5)	1250	625...1250	315...630			
160	112	136	160	160	100	800	1200	1600	800...1600	500...1000				
200	140	170	200	200	125	2000	1500	2000	1000...2000	625...1250				
225	158 (157.5)	191 (191.2)	225	225	125	1125	1688 (1667.5)	2250	1125...2250	625...1250				
250	175	213 (212.5)	250	250	160	1250	1875	2500	1250...2500	500...1000				
XT5	TMA	320	224	272	320	320	200	1600	2400	3200	1600...3200	1000...2000		
		400	280	340	400	400	250	2000	3000	4000	2000...4000	1250...2500		
		500	350	425	500	500	320	2500	3750	5000	2500...5000	1600...3200		
		630	441	535.5	630	630	400	3150	4725	6300	3150...6300	2000...4000		
XT6	TMA	800	560	680	800	800	500	4000	6000	8000	4000...8000	2500...5000		

Available settings for MA and TMG trip units:

Circuit Breaker	Trip Unit	In [A]	L - Overload			I - Short-circuit						
			I1 [A]			Neutral [A]		I3 [A]			Neutral [A]	
			MIN	MED	MAX	100%	50%	MIN	MED	MAX	100%	50%
XT1	MA	3.2						13	24	35		
		6.3						25	47	69		
		16						48	112	176		
		32						96	224	352		
		52						156	364	572		
		63						189	441	693		
		80						240	560	880		
		100						300	700	1100		
		125					375	875	1375			
XT2	MF	1								14		
		2								28		
		4									56	
		8.5									120	
		12.5									175	
	MA	20						120	200	280		
		32						192	320	448		
		52						314	520	728		
		80						480	800	1120		
		100						600	1000	1400		
		160					960	1600	2240			
XT3	MA	100						600	900	1200		
		125						750	1125	1500		
		160						960	1440	1920		
		200						1200	1800	2400		
XT4	MA	10						50	75	100		
		12.5						62.5	93.7	125		
		20						100	150	200		
		32						160	240	320		
		52						260	390	520		
		80						400	600	800		
		100						500	750	1000		
		125						625	937.5	1250		
		160						800	1200	1600		
		200					1000	1500	2000			
XT5	MA	320						2240	3200	4160		
		400						2800	4000	5200		
		500						3500	5000	6500		
XT2	TMG	16	11	14	16	16				16		16
		20	14	17	20	20				20		20
		25	18	21	25	25				25		25
		32	22	27	32	32				32		32
		40	28	34	40	40				40		40
		50	35	43	50	50				50		50
		63	44	54	63	63				63		63
		80	56	68	80	80				80		80
		100	70	85	100	100				100		100
		125	88	106	125	125				125		125
	160	112	136	160	160				300		300	
XT3	TMG	63	44	54	63	63				400		400
		80	56	68	80	80				400		400
		100	70	85	100	100				400		400
		125	88	106	125	125				400		400
		160	112	136	160	160				480		480
		200	140	170	200	200				600		600
XT5	TMG	250	175	213	250	250				750		750
		320	224	272	320	320			800	1200	1600	1600
		400	280	340	400	400			1000	1500	2000	2000
		500	350	425	500	500			1250	1875	2500	2500
	630	441	536	630	630			1575	2363	3150	3150	

Ekip Dip Overview

The Ekip Dip is a first level of electronic trip unit, used for the protection of AC networks.

Power Distribution Protection

- Ekip Dip LS/I
- Ekip Dip LIG
- Ekip Dip LSI
- Ekip Dip LSIG

Motor Protection

- Ekip M Dip I
- Ekip M Dip LIU

Generator Protection

- Ekip G Dip LS/I

- Key:
1. Dip switches for an overload protection setting.
 2. Dip switches for short-circuit and time delayed short-circuit protection settings.
 3. Slot for lead seal.
 4. Test connector.
 5. Power-on LED.



Dip switches

The dip switches on the front of the trip unit allow manual settings also when the trip unit is off.

LEDs

The LEDs on the front indicate the status of the release (on/off) and provide information about the protection tripped when the Ekip TT accessory is connected.

Front connector

The connector on the front of the unit allows the connection of:

- Ekip TT for trip testing; LED-test and signaling of the most recent trip.
- Ekip T&P, for connection to a laptop with the Ekip Connect program (thus measurement reading, as well as trip and protection function tests are made available for the user).

Thermal memory

All the Ekip Dip trip units include a thermal memory function. The trip unit records the trips which have occurred in the last few minutes. Since the trip causes overheating, in order to protect the cables and let them cool down, the trip unit imposes a shorter delay tripping time in case of a fault. This way, the system is protected against damage due to cumulative overheating. This can be disabled, if needed, by using the Ekip T&P.

External neutral

Ekip Dip trip units are available in both 3 and 4 poles. The 3-pole version with earth fault protection (G) can be equipped with an external sensor for the neutral phase. In this way, the external neutral phase is protected and uninterrupted.

Communication

- Using the dedicated Ekip Com module, XT2 and XT4 can communicate with Modbus RTU when they are equipped with the following trip units:
 - Ekip LSI
 - Ekip LSIG.

Characteristics of electronic Ekip Dip trip units

Operating temperature	-25°C...+70°C
Relative humidity	98%
Self-supplied	0.2xIn (single phase)*
Auxiliary supply (where applicable)	24V DC ± 20%
Operating Frequency	45...66Hz
Electromagnetic compatibility	IEC 60947-2 Annex F

*For 10A: 0,4xIn

Field of application	Trip Unit	L - Overload Protection		S - Selective Short-circuit Protection		I - Short-circuit Protection		
		Current Threshold	Trip Time	Current Threshold	Trip Time	Current Threshold	Trip Time	
Power Distribution Protection	Ekip Dip	LS/I	Adjustable	Adjustable	Adjustable	Adjustable	Adjustable	Fixed
		LIG	Adjustable	Adjustable	-	-	Adjustable	Fixed
		LSI	Adjustable	Adjustable	Adjustable	Adjustable	Adjustable	Fixed
		LSIG	Adjustable	Adjustable	Adjustable	Adjustable	Adjustable	Fixed
Motor Protection	Ekip M Dip I	I	-	-	-	-	Adjustable	Fixed
		LIU	Adjustable	Adjustable	-	-	Adjustable	Fixed
Generator Protection	Ekip G Dip	LS/I	Adjustable	Adjustable	Adjustable	Adjustable	Adjustable	Fixed

Power Distribution Protection

Ekip Dip LS/I

Ekip Dip LIG

Ekip Dip LSI

Ekip Dip LSIG

In [A]	10	25	40	63	100	160	250	320	400	630	800	1000	1250	1600
XT2	●	●		●	●	●								
XT4			●	●	●	●	●							
XT5							●	●	●	●				
XT6											●	●		
XT7											●	●	●	●

Motor Protection

Ekip M Dip I

In [A]	10	25	40	63	100	160	250	320	400	630	800	1000	1250	1600
XT2	●	●		●	●	●								
XT4			●	●	●	●	●							
XT5							●	●	●	●				
XT6											●	●		
XT7											●	●	●	●

Ekip M Dip LIU

In [A]	10	25	40	63	100	160	250	320	400	500	800	1000	1250	1600
XT2		●		●	●	●								
XT4			●	●	●	●								
XT5							●	●	●	●				
XT6											●			

Generator Protection

Ekip G Dip LS/I

In [A]	10	25	40	63	100	160	250	320	400	630	800	1000	1250	1600
XT2	●	●		●	●	●								
XT4			●	●	●	●	●							
XT5							●	●	●	●				
XT6											●	●		
XT7											●	●	●	●

Ekip Dip

Protection settings

Available settings for Ekip Dip trip units:

Ekip DIP LS/I & Ekip DIP LIG

ABB code	Protection Function	Threshold	Trip Time	Trip Curve
L	Overload	I1 = 0.4...1 x In with steps of 0.04	t1 at 3 x I1 = 12 - 36s 12 - 48s for XT7	t=k/I ²
S	Selective short-circuit	I2 = Off - 1 - 1.5 - 2 - 2.5 - 3 - 3.5 - 4.5 - 5.5 - 6.5 - 7 - 7.5 - 8 - 8.5 - 9 - 10 x In	t2 = 0.1 - 0.2s at 10 x In when t = k/I ²	t=k t = k or t = k/I ² for XT7
I	Short-circuit	I3 = Off - 1 - 1.5 - 2 - 2.5 - 3 - 3.5 - 4.5 - 5.5 - 6.5 - 7 - 7.5 - 8 - 8.5 - 9 - 10 x In	t3 ≤ 20ms t3 ≤ 30ms for XT7	t=k
G	Earth fault	I4 = Off - 0.20 - 0.25 - 0.45 - 0.55 - 0.75 - 0.80 - 1 x In I4 = Off - 0.2 - 0.3 - 0.4 - 0.6 - 0.8 - 0.9 - 1.0 x In for XT7	t4 = 0.1 - 0.2 - 0.4 - 0.8s at 3 x In when t = k/I ²	t=k t = k or t = k/I ² for XT7

Ekip DIP LSI & Ekip DIP LSIG

ABB code	Protection Function	Threshold	Trip Time	Trip Curve
L	Overload	I1 = 0.4...1 x In with steps of 0.02 I1 = 0.4 - 0.42 - 0.45 - 0.47 - 0.5 - 0.52 - 0.55 - 0.57 - 0.6 - 0.62 - 0.65 - 0.67 - 0.7 - 0.72 - 0.75 - 0.77 - 0.8 - 0.82 - 0.85 - 0.87 - 0.9 - 0.92 - 0.95 - 0.97 - 1 x In for XT7	t1 at 3xI1 = 3 - 12 - 36 - 60s at 3xI1 for XT2-XT4 3 - 12 - 36 - 48s for XT5 3 - 12 - 36 - MAX for XT6 3 - 12 - 24 - 36 - 48 - 72 - 108 - 144s for XT7	t=k/I ²
S	Selective short-circuit	I2 = Off - 1 - 1.5 - 2 - 2.5 - 3 - 3.5 - 4.5 - 5.5 - 6.5 - 7 - 7.5 - 8 - 8.5 - 9 - 10 x In I2 = Off - 0.6 - 0.8 - 1 - 1.5 - 2 - 2.5 - 3 - 3.5 - 4 - 5 - 6 - 7 - 8 - 9 - 10 for XT7	t2 = 0.05 - 0.1 - 0.2 - 0.4 for XT2-XT4-XT5-XT6 t2 = 0.1 - 0.2 - 0.3 - 0.4 - 0.5 - 0.6 - 0.7 - 0.8 for XT7 at 10xIn when t = k/I ²	t = k or t = k/I ²
I	Short-circuit	I3 = Off - 1 - 1.5 - 2 - 2.5 - 3 - 3.5 - 4.5 - 5.5 - 6.5 - 7 - 7.5 - 8 - 8.5 - 9 - 10 x In I3 = Off - 1.5 - 2 - 3 - 4 - 5 - 6 - 7 - 8 - 9 - 10 - 11 - 12 - 13 - 14 - 15 for XT7	t3 ≤ 20ms t3 ≤ 30ms for XT7	t=k
G	Earth fault	I4 = Off - 0.20 - 0.25 - 0.45 - 0.55 - 0.75 - 0.80 - 1 x In I4 = Off - 0.2 - 0.3 - 0.4 - 0.6 - 0.8 - 0.9 - 1.0 x In for XT7	t4 = 0.1 - 0.2 - 0.4 - 0.8s at 3 x In when t = k/I ²	t=k t = k or t = k/I ² for XT7

Note: t1 MAX for XT6: 42s for XT6 1000 and 72s for XT6 800

Ekip M DIP I

ABB code	Protection Function	Threshold	Trip Time	Trip Curve
I	Short-circuit	I ₃ = Off - 1 - 1.5 - 2 - 2.5 - 3 - 3.5 - 4.5 - 5.5 - 6.5 - 7 - 7.5 - 8 - 8.5 - 9 - 10 x I _n	t ₃ ≤ 15ms for XT5-XT4 t ₃ ≤ 20ms for XT5-XT4 t ₃ ≤ 30ms for XT7	t=k

Ekip M DIP LIU

ABB code	Protection Function	Threshold	Trip Time	Trip Curve
L	Overload	I ₁ = 0.4...1 x I _n with steps of 0.04	Operating Class for XT2-XT4: 3E - 5E - 10E - 20E Operating Class for XT5-XT6: 5E - 10E - 20E - 30E	t=k/I ²
I	Short-circuit	I ₃ = 6 - 7 - 8 - 9 - 10 - 11 - 12 - 13 x I _n	t ₃ ≤ 15ms for XT5-XT4 t ₃ ≤ 20ms for XT5-XT4 t ₃ ≤ 30ms for XT7	t=k
U	Phase loss (IEC 60947-4-1)	ON/OFF	When ON. t ₆ = 2s	t=k

Ekip G DIP LS/I

ABB code	Protection Function	Threshold	Trip Time	Trip Curve
L	Overload	I ₁ = 0.4...1 x I _n with steps of 0.04	t ₁ at 3 x I ₁ = 3 - 6s	t=k/I ²
S	Selective short-circuit	I ₂ = Off - 1 - 1.5 - 2 - 2.5 - 3 - 3.5 - 4.5 - 5.5 - 6.5 - 7 - 7.5 - 8 - 8.5 - 9 - 10 x I _n	t ₂ = 0.05 - 0.075 - 0.1 - 0.2 at 10 x I _n when t = k/I ₂	t=k t = k or t = k / I ² for XT7
I	Short-circuit	I ₃ = Off - 1 - 1.5 - 2 - 2.5 - 3 - 3.5 - 4.5 - 5.5 - 6.5 - 7 - 7.5 - 8 - 8.5 - 9 - 10 x I _n	t ₃ ≤ 20ms t ₃ ≤ 30ms for XT7	t=k

Ekip Dip

Tolerances

Tolerances in case of:

- Self-powered trip unit at full power
- 2 or 3 phase supply

Trip Unit	Protection	Trip Threshold	Trip Time
Ekip DIP LS/I Ekip DIP LIG Ekip G Dip LS/I	L	trip between 1,05...1,3 x I _l according IEC 60947-2	±10% up to 4xI _n ±20% from 4xI _n
	S	±10%	XT2-XT4-XT5-XT6: 15% ⁽²⁾ XT7: t=k: ±10% t=k/I ² : ±15% up to 4xI _n ±20% from 4xI _n
	I	±10%	-
	G ⁽¹⁾	±10%	XT2-XT4-XT5-XT6: ±20% XT7: ±15%
Ekip DIP LSI Ekip DIP LSIG	L	trip between 1,05...1,3 x I _l according IEC 60947-2	XT2-XT4-XT5-XT6: ±10% up to 4xI _n ±20% from 4xI _n XT7: ±10% up to 6xI _n ±20% from 6xI _n
	S	±10%	XT2-XT4-XT5-XT6: t=k: ±10% up to 4xI _n ±20% from 4xI _n t=k/I ² : ±15% t ₂ >100ms ±20ms t ₂ ≤100ms XT7: t=k the better of the two data: ±10% or ± 40ms t=k/I ² : ±15% up to 6xI _n ±20% from 6xI _n
	I	±10%	-
	G ⁽¹⁾	XT2-XT4-XT5-XT6: ±10% XT7: ±7%	XT2-XT4-XT5-XT6: ±15% XT7: t=k the better of the two data: ±10% or ± 40ms t=k/I ² : ±15% up to 6xI _n ±20% from 6xI _n
Ekip M Dip I Ekip M Dip LIU	L	trip between 1,05...1,2xI _l	±10% up to 4xI _n ±20% up to 4xI _n
	I	±10%	-
	U	±10%	±10%

Note: When the trip unit is used at 400Hz the tripping time tolerance is +/- 25%

(1) G protection is inhibited for currents higher than: - 2xI_n with XT2 and XT4
- 4xI_n with XT5 and XT6

(2) for G Dip LS/I: - ±10% t₂ > 100ms
- ±20% t₂ ≤ 100ms

Tolerances in other conditions:

Trip Unit	Protection	Trip Threshold	Trip Time
Ekip DIP LS/I	L	trip between 1,05...1,3 x I _l according IEC 60947-2	±20%
Ekip DIP LIG	S	±10%	±20%
Ekip G Dip LS/I	I	±15%	≤60ms
	G	± 30% For I _n =10A I _{fault} min=4A For I _n =25A I _{fault} min=9A	± 20% For I _n =10A,25A: ±30%
Ekip DIP LSI	L	trip between 1,05...1,3 x I _l according IEC 60947-2	±20%
Ekip DIP LSIG	S	±10%	±20%
	I	±15%	≤60ms
	G	XT2-XT4-XT5-XT6 ± 30% For I _n =10A I _{fault} min=4A For I _n =25A I _{fault} min=9A XT7 ± 7%	XT2-XT4-XT5-XT6 ± 20% For I _n =10A,25A: ±30% XT7 t=k the better of the two data: ±10% or ±40ms t=k/I ² : ± 15%
Ekip M Dip I	L	trip between 1.05...1.2xI _l	±20%
Ekip M Dip LIU	I	±15%	≤60ms
	U	±20%	±20%

Ekip Touch/Hi-Touch

Overview

The Ekip Touch/Hi-Touch provide a complete series of protections and high accuracy measurements of all electrical parameters and can be integrated perfectly with the most common automation and supervision systems.

Power Distribution Protection

- Ekip Touch LSI
- Ekip Touch LSIG
- Ekip Touch Measuring LSI
- Ekip Touch Measuring LSIG
- Ekip Hi-Touch LSI
- Ekip Hi-Touch LSIG

Motor Protection

- Ekip M Touch LRIU

Generator Protection

- Ekip G Touch LSIG
- Ekip G Hi-Touch LSIG

Key:

1. Power-on LED; pre-alarm LED; alarm LED
2. Test and programming connector
3. Display
4. Home push-button to return to homepage;
5. Push-button for testing and tripping information



Communication & Connectivity

The Ekip Touch/Hi-Touch trip units can be integrated perfectly into all automation and energy management systems to improve productivity and energy consumption and for remote control. The circuit-breakers can be equipped with communication modules for Modbus, Profibus, and DeviceNet™ protocols as well as Modbus TCP, Profinet and EtherNet/IP™. The modules can be easily installed even at a later date.

A solution with integrated modules is useful when the space in the switchboard is limited, but also a solution with external Ekip Cartridge modules is highly suitable for when an advanced control and communication system is required.

Furthermore, the IEC61850 communication module enables connection to automation systems widely used in medium voltage power distribution to create intelligent networks (Smart Grids). All circuit-breaker functions are also accessible via the Internet, in complete safety, through the Ekip Link switchgear supervision system and the Ekip Control Panel. Furthermore, with an easy connection thanks to the Ekip Com Hub module, the circuit-breakers allow the system to be monitored via ABB Ability™ EDCS.

Efficiency and measurements

Achieving maximum efficiency of an electrical installation requires intelligent management of power supplies and energy use. For this reason, the new technologies used in the Ekip Touch/Hi-Touch trip units allow the productivity and reliability of installations to be optimized while reducing consumption and fully respecting the environment. These advanced functionalities, together with the protection and communication functions contribute to making Tmax XT with Ekip Touch/Hi-Touch the circuit-breaker that maximizes efficiency in all low-voltage electrical installations.

With 1% accuracy on power and energy measurements, the trip units are certified according to the IEC 61557-12 Standard. Ekip Touch/Hi-Touch trip units are no longer simply protection devices, but integrate multimeter and network analyzer functionality, thus guaranteeing a top level energy management system.

Digital Upgrade

Ekip Touch/Hi-Touch trip units are available in different versions, to enable a wide range of functions: from the Ekip Touch to the Ekip Hi-Touch, it is always possible to customize any device thanks to the additional digital modules.

All functions are available on the ABB Ability Marketplace™ and can be added both when ordering the trip unit as well as after the installation of the circuit-breaker. Ekip Connect efficiently provides desired functions, and EPiC makes the operation even faster, directly from a Smartphone.

Several packages are available to download, and all of them are designed to save time, costs, and space, since no external devices are needed.

Interface

It is possible to interact with the trip unit in several ways via:

- **The front display**

An LCD display with a push button ensures easy navigation on the XT2 and XT4, while a color touch screen is available for intuitive and quick navigation on the XT5 and XT7, together with the possibility of viewing the waveform for different parameters.

- **Smartphone via Bluetooth**

Thanks to the integrated Bluetooth functionality, it is possible to set and check all the measurements and information directly from a smartphone thanks to the EPiC app. Even when the cabinet door is closed, it is always possible to carry out maintenance in a safer way.

- **PC with Ekip Connect**

It is also easy to interact with the trip unit with a PC. Thanks to the Ekip T&P cable the trip unit can be easily connected to a USB PC port and using the Ekip Connect program it is possible to fully interact with the trip unit.

Ekip Touch/Hi-Touch

Overview

Supply

The Ekip Touch/Hi-Touch protection trip unit is self-supplied through the current sensors and does not require an external supply for the basic protection functions or for the alarm indication functions. The trip units for all the circuit-breakers start to power on from a minimum of $0.2 \times I_n^*$ and activate the indication functions, ammeter and the display. All protection settings are stored in a non-volatile memory that maintains the information, even without a power supply. An auxiliary supply can also be easily connected. In fact, the trip unit can be supplied by means of a galvanically isolated 24V DC auxiliary voltage with the following characteristics:

Parameter	Operation limits
Voltage	24V DC galvanically isolated*
Tolerance	±10%
Maximum wave	±5%
Maximum surge current @24V	10A for 5ms
Maximum rated power @24V	4W
Connecting cable	Insulated with ground cable (characteristics equal to or greater than Belden 3105A/B)

The insulation characteristics must refer to the IEC 60950 (UL 1950) or their equivalent

The Ekip Supply module can be connected to both DC and AC current power supplies to activate additional functions such as:

- using the unit with circuit-breaker open;
- using additional modules such as Ekip Signalling and Ekip Com;
- connection to external devices such as Ekip Multimeter and Ekip Control Panel;
- recording the number of operations;
- G protection with values below 100A or below $0.2 \times I_n^*$;
- zone selectivity;
- Gext and MCR protection functions.

Supply	Ekip Supply	
Nominal voltage	24-48 V DC	110-240 V AC/DC
Voltage range	21.5-53 V DC	105-265 V AC/DC
Rated power (including modules)	10W max.	10W max.
Inrush current	~10A for 5 ms	~10A for 5 ms

The Ekip Touch/Hi-Touch is also supplied with a battery that enables the cause of the fault to be indicated after a trip. In addition, the battery enables the date and time to be updated, thus ensuring the chronology of events. When the Ekip Touch/Hi-Touch is operating, it uses an internal control circuit to automatically indicate that the battery is flat. Furthermore, when the unit is switched off a battery test can be run by simply pressing the iTest key.

* for XT2 with $I_n=40A$: $0.3 \times I_n$; for XT2 & XT4 with $I_n=100A$: $0.25 \times I_n$

Rating Plug

The XT5 and XT7 trip units allow the rated current to be modified by simply changing the front rating plug. Thus, an upgrade of the circuit-breaker, whenever needed, can be carried out without replacing the circuit-breaker.

Commissioning

The setting, testing and downloading of reports can be carried out directly from a smartphone, tablet or PC. In addition, the commissioning stage can be further accelerated, minimizing the possibility of errors, by directly configuring the protection trip unit with the DOC design software settings.

Test function

The test port and the iTest key on the front of the protection unit can be used to carry out circuit-breaker tests by connecting one of the following devices:

- The Ekip TT, which allows trip tests, LED tests and checks for the absence of alarms detected by the watchdog function;
- The Ekip T&P, which permits not only trip tests and LED tests but also testing of the individual protection functions and the saving of the relative report;
- The iTest key, to run a battery test when the circuit-breaker is disconnected.

The following table shows the main features for each version of the trip unit. The additional features can be added to the trip unit at the time of purchase or after via the ABB Ability Marketplace™.

Trip Unit	Current measurement & protection	Voltage, power, energy measurements	Voltage, power, energy protections	Embedded functions*
Ekip Touch LSI	●	○	○	○
Ekip Touch LSIG	●	○	○	○
Ekip Touch Measuring LSI	●	●	○	○
Ekip Touch Measuring LSIG	●	●	○	○
Ekip Hi-Touch LSI	●	●	●	●
Ekip Hi-Touch LSIG	●	●	●	●
Ekip M Touch LRIU	●	●	●	●
Ekip G Touch LSIG	●	●	●	●
Ekip G Hi-Touch LSIG	●	●	●	●

● Default available

○ Additionable features

* See the following pages for more details

Ekip Touch/Hi-Touch

Overview

Watchdog

All the Ekip Touch/Hi-Touch trip units for the Tmax XT ensure high reliability thanks to an electronic circuit that periodically checks the continuity of the internal connections, such as the trip coil, rating plug and each current sensor (ANSI 74). In the event of an alarm, a message is shown on the display, and if it is set during the installation phase, the trip unit can command the opening of the circuit-breaker. If a protection function intervenes, Ekip Touch/Hi-Touch always checks that the circuit-breaker has been opened by auxiliary contacts that indicate the position of the main contacts. Otherwise, Ekip Touch/Hi-Touch indicates an alarm (ANSI BF code Breaker Failure) to command the opening of the circuit-breaker upstream.

Ekip Touch/Hi-Touch also features self-protection, which ensures the correct operation of the unit in overtemperatures (OT) inside the protection trip unit.

The following indications or controls are available:

- “Warning” LED for temperature below -20 °C or above +70 °C, at which point the trip unit operates correctly with the display switched off.
- “Alarm” LED for temperature outside the operating range, at which point the trip unit commands the opening of the circuit-breaker (if set during the configuration phase).

Power Distribution Protection

- Ekip Touch LSI
- Ekip Touch LSIG
- Ekip Touch Measuring LSI
- Ekip Touch Measuring LSIG
- Ekip Hi-Touch LSI
- Ekip Hi-Touch LSIG

In [A]	40	63	100	160	250	320	400	630	800	1000	1250	1600
XT2	●	●	●	●								
XT4			●	●	●							
XT5					●	●	●	●				
XT7									●	●	●	●

Motor Protection

- Ekip M Touch LRIU

In [A]	40	63	100	160	200	250	320	400	500	800	1000	1250
XT2	●	●	●	●								
XT4			●	●	●							
XT5						●	●	●	●			
XT7										●	●	●

Generator Protection

- Ekip G Touch LSIG
- Ekip G Hi-Touch LSIG

In [A]	250	320	400	630	800	1000	1250	1600
XT5	●	●	●	●				
XT7					●	●	●	●

Ekip Touch/Hi-Touch

Protection functions

The Ekip Touch/Hi-Touch enables all the protection functions to be set with a few simple steps.

Thanks to the ABB Ability Marketplace™, it is always possible to customize the Ekip Touch/Hi-Touch trip units when ordering and also when the circuit-breaker is already installed by using the Ekip Connect App.

Each trip unit has a default protection set, as shown in the table below. Adding other functional packages to this set is always possible, either directly when ordering the circuit-breaker, or via ABB Ability Marketplace™ at a later time.

The following protection software packages are available to be added to any version of Ekip Touch/Hi-Touch trip units:

- Voltage Protection
- Voltage Protection Advanced
- Frequency Protection
- Power Protection
- ROCOF Protection
- Adaptive Protection

ABB Code	ANSI Code	Function	Ekip Touch LSI	Ekip Touch LSIG	Ekip Touch Measuring LSI
Default Protection					
L	49	Overload	●	●	●
S	50 TD / 68 / 51	Selective short circuit	●	●	●
I	50	Instantaneous short-circuit	●	●	●
G	50N/50N TD/68/51N	Earth Fault		●	
N		Neutral	●	●	●
2I	50	2nd instantaneous short-circuit	●	●	●
MCR		Closing on short-circuit	●	●	●
linst		Instantaneous high intensity short-circuit protection	●	●	●
IU	46	Current unbalance	●	●	●
Harmonic Distortion					
T		Temperature	●	●	●
Hardware trip					
Current Thresholds					
S2	50 TD/68	2nd Time delayed overcurrent	●	●	●
Voltage Protection package					
Phase Sequence	47	Cyclical direction of the phases	○	○	○
UV	27	Undervoltage	○	○	○
OV	59	Overvoltage	○	○	○
UV2	27	2nd Undervoltage	○	○	○
OV2	59	2nd Overvoltage	○	○	○
VU	47	Voltage unbalance	○	○	○
Voltage Protection Advanced package					
S(V)	51V	Voltage controlled overcurrent	○	○	○
S(V) 2nd	51V	2nd Voltage controlled overcurrent	○	○	○
RV	59N	Residual overvoltage	○	○	○

● Available as standard

○ Available as software package to be ordered via ABB Marketplace™ or during the circuit-breaker ordering phase. To add this function, the Measuring package must be installed first.

Ekip Touch Measuring LSIG	Ekip Hi-Touch LSI	Ekip Hi-Touch LSIG	Ekip M Touch LRIU	Ekip G Touch LSIG	Ekip G Hi-Touch LSIG
●	●	●		●	●
●	●	●	●	●	●
●	●	●	●	●	●
●		●	●	●	●
●	●	●		●	●
●	●	●	●	●	●
●	●	●	●	●	●
●	●	●	●	●	●
●	●	●	●	●	●
●	●	●	●	●	●
●	●	●	●	●	●
●	●	●	●	●	●
●	●	●	●	●	●
●	●	●	●	●	●
●	●	●	●	●	●
○	●	●	●	●	●
○	●	●	●	●	●
○	●	●	●	●	●
○	●	●	●	○	●
○	●	●	●	○	●
○	●	●	●	●	●
○	○	○	○	●	●
○	○	○	○	○	●
○	○	○	○	●	●

Ekip Touch/Hi-Touch

Protection functions

ABB Code	ANSI Code	Function	Ekip Touch LSI	Ekip Touch LSI G	Ekip Touch Measuring LSI
Frequency Protection package					
UF	81L	Underfrequency	○	○	○
OF	81H	Overfrequency	○	○	○
UF2	81L	2nd Underfrequency	○	○	○
OF2	81H	2nd Overfrequency	○	○	○
Power Protection package					
RP	32R	Reverse active power	○	○	○
Cos φ	78	Power Factor	○	○	○
D	67	Directional overcurrent	○	○	○
RQ	40/32R	Loss of field or reverse reactive power	○	○	○
OQ	320F	Reactive overpower	○	○	○
OP	320F	Active overpower	○	○	○
UP	32LF	Active underpower	○	○	○
ROCOF Protection package					
ROCOF	81R	Rate of change of frequency	○	○	○
Adaptive Protection package					
Set A-B		Dual Setting	○	○	○
Motor Protection					
L		Motor protection overload			
R	51LR	Rotor blockage			
U	46	Phase lackand/or unbalance			
Un		Phase unbalance			
Uc	37	Undercurrent			
Protection with additional modules					
SC	25	Synchrocheck	●	●	●
Ekip CI		Motor contactor interface protection			
PTC		PTC for temperature			
G ext	50G TD/86/51G	Earth fault	● ⁽¹⁾	● ⁽¹⁾	● ⁽¹⁾
Rc	64 50N TD 87N	Residual current / Differential ground fault	● ⁽¹⁾	● ⁽¹⁾	● ⁽¹⁾

● Available

○ Available as software package to be ordered via ABB Ability Marketplace™ or during the circuit-breaker ordering phase. To add this function, the Measuring package must be installed first.

Note:

1) Available with additional module for XT7 and XT7 M only

When an Ekip Touch LSI or LSI G trip unit is upgraded with one of the following packages:

- Voltage Protection
- Voltage Protection Advanced
- Frequency Protection
- Power Protection
- ROCOF Protection

it is mandatory to add first the Measuring package described on the following pages.

Ekip Touch/Hi-Touch

Protection functions

The Ekip Touch/Hi-Touch can be customized with the protection functions required.

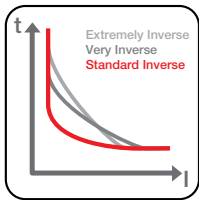

L – Overload (L - ANSI 49)

This function is used for protection against overloads. It allows the setting of the trip threshold, trip time and pre-alarm threshold. Three different types of trip curves are available:

1. $t = k/I^2$ with an inverse long time;
2. IDMT in accordance with IEC 60255-151 for coordination with medium voltage protection, available according to Standard Inverse (SI), Very Inverse (VI) and Extremely Inverse (EI) curves;
3. With a $t = k/I^4$ curve for better coordination with upstream circuit-breakers or fuses.

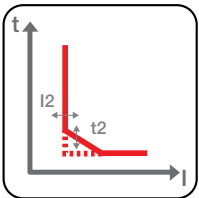

S – Time-delayed overcurrent (S - ANSI 51 & 50TD)

This function is used to protect against selective short-circuits. If necessary, it can be disabled, or if needed, only the trip can be excluded keeping the alarm indication, to be used in installations where continuity of service is required. With a constant trip time ($t = k$), or constant specific let through energy ($t = k/I^2$).

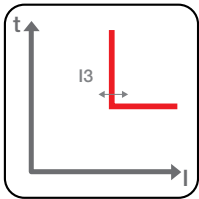

I – Short-circuit

This function is used for instantaneous protection against short-circuits. The trip threshold is adjustable and, if needed, the protection can be disabled.

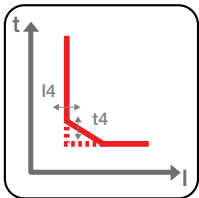

G - Ground fault

This function protects against earth faults. The trip threshold and trip time are adjustable. When needed, the protection can be disabled.

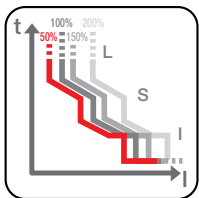

Neutral protection

This function is used to adjust the setting provided from protections L, S and I on the Neutral pole with a control factor which is different from the other phases. It is available with values at 50%, 100%, 150% or 200% of the phase currents. It can be disabled if necessary.

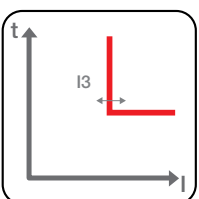

2I - Second protection against instantaneous overcurrent

This function protects against the instantaneous short-circuit (e.g. I protection) and it is enabled with an activation event (or command), that can be programmed by the user. It can be activated for different uses in three ways:

- locally, directly on the Ekip display unit
- locally, with a smartphone with the EPiC app via Bluetooth
- locally, with a PC with the Ekip Connect program
- remotely, via any Ekip Com module connected to the circuit-breaker
- remotely, via a switch wired through an Ekip Signalling module.

When active, the Ekip display unit will show a confirmation of the activation and a red LED alarm will flash on the diagnosis bar.

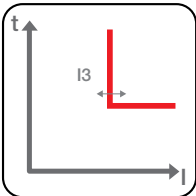

MCR – Closing on Short-circuit

This protection uses the same algorithm as the I protection, limiting the operation to a settable time window starting from the closing of the circuit-breaker. The protection can be disabled, when needed. The function is active with an auxiliary supply.

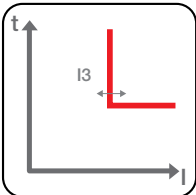

Iinst

This guarantees the integrity of the circuit-breaker and installation in the case of particularly high current values requiring shorter reaction times than those provided by the instantaneous short-circuit protection. The protection cannot be disabled, and the tripping threshold and time are defined by ABB.

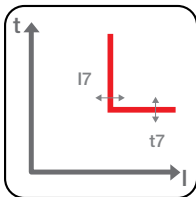

IU - Current unbalance (ANSI 46)

This function protects against an unbalance between the currents of the single phases protected by the circuit-breaker.

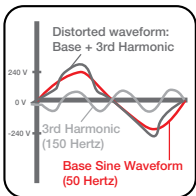

Harmonic distortion

This allows a control alarm to be activated for a distorted waveform. If enabled, an alarm is activated for waveform factors higher than 2.1.

T - Temperature

This protects the circuit-breaker against abnormal temperatures recorded by the unit. It is always active, and has two states, according to the temperature:

- Warning: $-25 < t < -20$ or $70 < t < 85$ Display off; Warning LED on @ 0.5Hz.
- Alarm: $t < -25$ or $t > 85$ Display off; Alarm and Warning LEDs on @2Hz; Circuit-breaker opening command.

Hardware Trip

This protects against internal disconnections of the circuit-breaker. If enabled, a fault is signaled and an opening command is sent if one or more of the following events are detected:

- Current sensors disconnected (phase or external if enabled)
- Rating plug disconnected (only for XT5 and XT7)
- Trip coil disconnected (only signaling)
- Incompatibility between protection release and mainboard (only for XT7)
- Internal problems with the release.

Current thresholds

This function enables the realization of four independent thresholds to be indicated to enable corrective actions before the overload L protection trips the circuit-breaker. For example, by disconnecting the loads controlled by an Ekip Signalling device positioned downstream of the circuit-breaker.

Ekip Touch/Hi-Touch

Protection functions

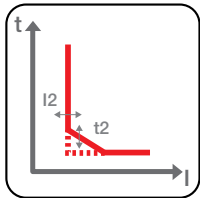

S2 - Second time-delayed overcurrent protection

In addition to the Standard S protection, a second (excludible) time-constant protection is available that enables two independent thresholds to be set to ensure precise selectivity, especially under highly critical conditions.

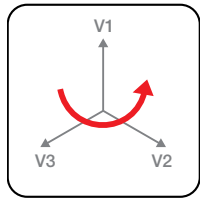

Phase sequence

This trips in case of an inversion of the phase sequence.

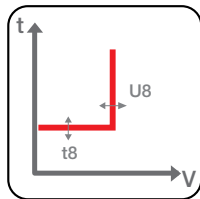

UV - Undervoltage (UV - ANSI 27)

With a constant trip time ($t = k$), this trips when the phase voltage falls below the set threshold.

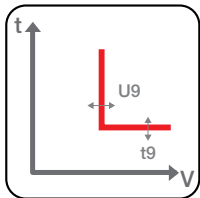

OV - Overvoltage (OV - ANSI 59)

With a constant trip time ($t = k$), this trips when the phase voltage exceeds the set threshold.

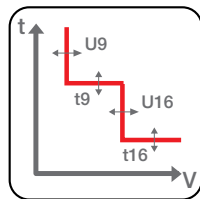

UV2 & OV2 - Second protection against undervoltage and overvoltage (ANSI 27 and 59)

This enables two minimum and maximum voltage thresholds to be set with different delays to discriminate, for example, between voltage dip transients due to the start-up of a motor and an actual fault.

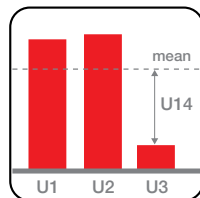

VU - Voltage unbalance (VU - ANSI 47)

With a constant trip time ($t = k$), this protects against an unbalance between the voltages of the single phases that are protected by the circuit-breaker.

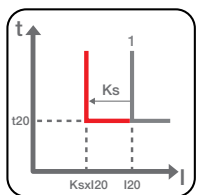

S(V) - Voltage controlled overcurrent protection (ANSI 51V)

This provide protection from a maximum current with a constant trip time ($t = k$) that is sensitive to the voltage value. Following a voltage drop, the current set threshold decreases in steps or linearly. It is possible to set the operating mode to: active, alarm only, or deactivated. The protection operates also with the circuit-breaker open, thus allowing fault identification before circuit-breaker closing.

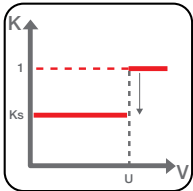

In step mode (controlled mode) the protection is tripped at a set threshold (I_{20}) if the voltage is above U , whereas it is tripped at the lower threshold of the factor K_s ($I_{20} * K_s$) if the voltage is below U .

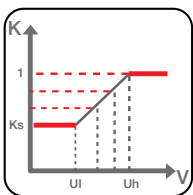

In linear mode (restrained mode) two voltage limits are selected within which the protection is tripped at the set threshold (I_{20}) reduced by a factor of K corresponding to the measured voltage. The variation of the factor K is proportional to the voltage, and for voltages greater than the upper threshold (U_h) the threshold I_{20} works, whereas for voltages below the lower threshold (U_l) the minimum threshold ($I_{20} * K_s$) applies.

S2(V) – 2nd protection against voltage-controlled overcurrent protection (ANSI 51V)

Available in addition to the protection S(V), this enables total selectivity to be achieved in all installations. It is possible to set the operating mode to: active, alarm only, or deactivated. The protection also operates with the circuit-breaker open, thus allowing fault identification before circuit-breaker closing.

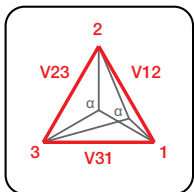

Residual overvoltage (ANSI 59N)

With a constant trip time ($t = k$), this protects against insulation loss in systems with insulated neutral or with neutral earthed with impedance. It is possible to set the operating mode to: active, alarm only, or deactivated. The protection also operates with the circuit-breaker open, thus allowing fault identification before circuit-breaker closing.

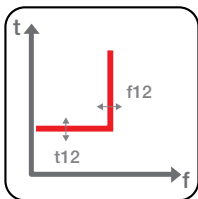

UF Underfrequency (ANSI 81L)

With a constant trip time ($t = k$), this trips when the network frequency falls below a set threshold.

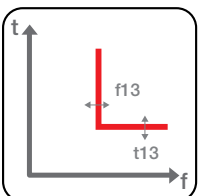

OF Overfrequency (ANSI 81H)

With a constant trip time ($t = k$), this trips when network frequency exceeds a set threshold.

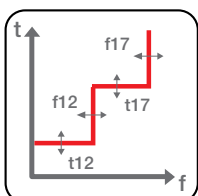

UF2 & OF2 Second protection against underfrequency and overfrequency (ANSI 81L and 87H)

This enables two minimum and maximum frequency thresholds to be set simultaneously. For example, just an alarm can be set for tripping when the first threshold is reached, and the circuit-breaker can be set to be opened when the second threshold is reached.

Ekip Touch/Hi-Touch

Protection functions

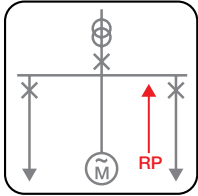

RP Reverse active power

With a constant trip time ($t = k$), this trips when the total active power – in the opposite direction of the current exceeds the set threshold.

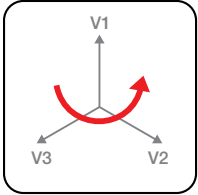

Cos ϕ Power factor

Available with a three-phase threshold, this provides a warning when the system operates with a power factor that is lower than the set power factor.

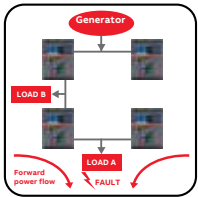

D Directional overcurrent

This form of protection is able to recognize the direction of the current during the fault period and thus detect if the fault is upstream or downstream of the circuit-breaker. The protection, with a fixed time trip curve ($t=k$), intervenes with two different time delays (t_{7bw} and t_{7fw}), according to the current direction. In ring distribution networks, it enables the identification and disconnection of the area in which a fault has occurred, while maintaining operation in the rest of the installation.

Zone selectivity for protection D (ANSI 68)

This enables the possibility to interconnect more circuit-breakers, so that, in case of a fault, the affected area can be disconnected nearest to the fault and operation in the rest of the installation is maintained. It is possible to enable directional zone selectivity alternatively to zone selectivity of S and G protections. This also works in the presence of an auxiliary supply.

Start-up function for protection D

This enables higher trip thresholds to be set at the outgoing point, as available for protections S, I and G.

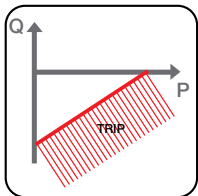

RQ Loss of field or reverse reactive power (ANSI 40 or 32RQ)

With a constant trip time ($t = k$) this circuit-breaker trips when the total reactive power absorbed by the generator exceeds the set threshold. It is possible to select a constant threshold ($k=0$) or a function of the delivered active power of the generator ($k \neq 0$).

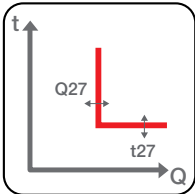

OQ Reactive overpower (ANSI 32OF)

With a constant trip time ($t = k$), this trips when the reactive power exceeds the set threshold in the direction from the generator to the network.

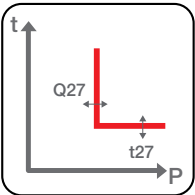

OP Active overpower (ANSI 32OF)

With a constant trip time ($t = k$), this trips when the active power exceeds the threshold set in the delivering direction from the generator.

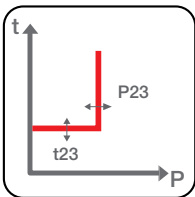

UP Active underpower (ANSI 32LF)

With a constant trip time ($t = k$), this trips when the active power delivered by the generator is lower than the set threshold. It is possible to disable the protection temporarily to manage the start-up phase by setting a time window from the closing of the circuit-breaker, by using an electric signal or via incoming communication to a relay.

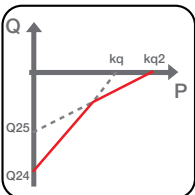

RQ Second protection against loss of field or reverse reactive power (ANSI 40 or 32R)

This functions as the above mentioned RQ protection. These two functions can be active and used at the same time, thus allowing the under-excitation curve of the generator to be accurately followed and avoiding unwanted disconnections.

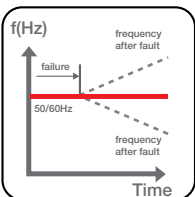

ROCOF Rate of change of frequency (ANSI 81R)

This enables both positive and negative frequency variations to be detected rapidly. The threshold is constant and the function trips when the frequency variation in Hz/s is greater than the set threshold. It is possible to set the operating mode to: active, alarm only, or deactivated. The protection enables the identification and disconnection of the area where the fault has occurred while maintaining operation in the rest of the installation.

Ekip Touch/Hi-Touch

Protection functions

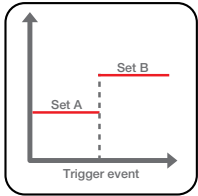

Adaptive protection: dual setting of protections (Set A-B)

The Ekip Hi-Touch can store a set of alternative parameters (set B) for all protections. This second set can replace the default series (set A) with an external control. A typical application for dual settings may be when an emergency source is activated in the system, causing a change of load capacity and short-circuit levels, and in cases of switchgear maintenance to protect the operator against electric arcs (the minimum trip delays of set B guarantee safety for the operator).

It is possible to activate series B by:

- Digital input, available with an Ekip Signalling module;
- Communication network, by means of one of the Ekip Com communication modules;
- Directly from the Ekip Hi-Touch display;
- Using a settable internal time, after the circuit-breaker has closed.

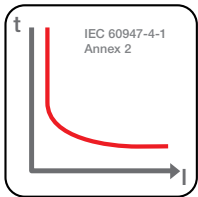

L Motor protection overload in compliance with Standard IEC 60947-4-1 Annex 2

The L function protects the motor against overloads in accordance with the indications and classes defined by Standard IEC 60947-4-1 and the Annex 2. The trip time is established by choosing the appropriate trip class, which depends on the motor that must be protected. In addition to this protection, the thermal memory function (implemented in accordance with Standard IEC60255-8 and the above-mentioned Standard) is permanently activated. After tripping the Ekip M Touch LRIU, the thermal memory is active for a time that depends on the trip class selected (see table).

The protection unit will trip faster than the time established for a cold fault condition if a new overload occurs before the thermal memory automatically resets (hot trip condition). The protection has a “start-up” stage from the moment the current exceeds 0.25xIn to the moment the minimum time of the selected trip class is reached.

TRIP CLASS	CLASS MIN	CLASS MAX	TMEM RESETTING TIME
5E	3s	5s	5 min
10E	5s	10s	10 min
20E	10s	20s	20 min
30E	20s	30s	33 min

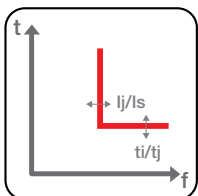

R Protection against rotor blockage

This protects the motor in two different ways, depending on whether the fault occurs on startup or during normal operation. The behavior in the two operating conditions is defined by the Standard IEC 947-4-1 in Annex 2. In the first case (Jam), the operation of the R function protects the motor against rotor jamming during normal operation. The R (Jam) protection function works in conjunction with the L protection to ensure that the motor start-up phase is completed. The R (Jam) protection is inhibited during the start-up phase for the same time as the minimum time in the selected overload protection trip class. Once this time has elapsed, the R protection is activated and causes the circuit-breaker to trip if the current remains above the current threshold setting (I5) for longer than the time (t5) setting of the protection. In the second case (Stall), the protection is designed to operate to protect the motor against rotor jamming upon start-up. If activated, the R (Stall) protection is not inhibited during start-up and causes the circuit-breaker to open if the current remains above the current threshold setting (I8) for longer than the time setting (t8) of that protection. The protection has a “start-up” stage from the moment the current exceeds 0.25xIn to the moment the minimum time of the selected trip class is reached.

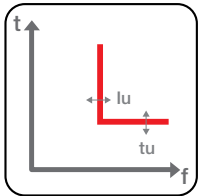

U Protection against phase loss and/or unbalance

This can be implemented when the motor must be promptly protected owing to the absence of a phase. The protection trips if the r.m.s. value of at least one of the phase currents drops below the level equal to 0.1 times the rated current of the trip unit and a second phase exceeds 0.25 times the rated current. The circuit-breaker is opened if the current value fails to rise above this level within 2 sec. During start-up, the tripping time of the protection is the lowest value between 2 sec or half the minimum time of the start-up class. The protection has a “start-up” stage starting from the moment the current exceeds $0.25I_n$ to the moment the minimum time of the selected trip class is reached.

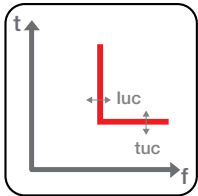

Uc Undercurrent protection

This function protects the motor from operating in conditions where the load is reduced or null. The circuit-breaker is opened if all the phases remain below the threshold setting I_9 for delay-time t_9 . The protection has a “start-up” stage from the moment the current exceeds $0.25I_n$ to the moment the minimum time of the selected trip class is reached.

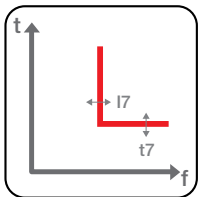

IU Protection against phase unbalance

This unit is used when a motor needs to be protected against differences in the currents circulating in the phases. Threshold setting I_7 defines the maximum level of difference between each phase and the mean value of the three phases. If a phase differs more than its set level from the mean value, the protection opens the circuit-breaker once its time-delay setting (t_7) has elapsed. The protection is activated only if all three phase currents exceed $0.25I_1$. During the start-up phase, the tripping time is the lowest value between t_7 or half the minimum time of the start-up class. The protection has a “start-up” stage from the moment the current exceeds $0.25I_n$ to when the minimum time of the selected trip class is reached.

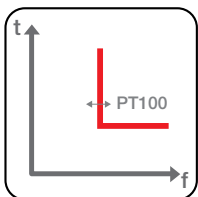

PTC Temperature protection

In its initial configuration, this trip unit is set up to receive an incoming signal from a PTC sensor installed on the motor. The operating thresholds of the protection are defined in accordance with the Standard IEC 60947-8. If the threshold is exceeded, the trip unit opens the circuit-breaker after a 1 sec time-delay.

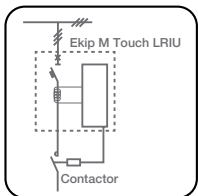

Ekip CI Contactor Interface for motor protection

The breaking capacity of a contactor is definitely lower than a circuit-breaker, but with a number of possible operations consistently higher than those of the breaker (approx. 1,000,000): motor protection and operation are thus optimized when these two devices are used in conjunction with each other. In its initial configuration, the trip unit is set for operation in Normal mode, activating the contactor by means of the Ekip CI module if one of the protections trip (with the exception of protections I and G). If the configuration is changed from Normal to Heavy, the trip unit opens the circuit-breaker directly without transmitting the command to the contactor. An auto-reset function allows the actuation status of the Ekip CI to reset automatically after the contactor has tripped owing to the L function, once an adjustable time from 1 to 1000s has elapsed. Auto-reset can occur only in Normal mode. A BACK UP function is also available and deals with situations where an opening command transmitted to the contactor via module Ekip CI has not been successful. In this case, the EKIP M Touch LRIU trip unit sends an opening command to the circuit-breaker after waiting for the set time T_x . The actuation time of the contactor given by the manufacturer must be considered when the time-delay setting T_x is entered. The function is active with an auxiliary supply.

Ekip Touch/Hi-Touch

Protection functions

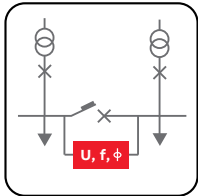

SC Synchrocheck

By comparing voltage, frequency and phase values of the two circuits involved, the synchronism control function indicates that the synchronism conditions necessary to allow the circuit-breaker to be closed have been reached. The function is available in two operating modes:

• In systems with both busbars supplied, where synchronism is determined by:

1. the voltage of the two half-busbars above the U_{live} threshold for the set time
2. the difference of the two voltages below the threshold ΔU
3. the difference of the frequency of the two voltages below the threshold Δf
4. the difference of the phase of the two voltages below the threshold Δ
5. the desirable time for synchronism condition t_{syn}
6. the circuit-breaker.

• In systems with an out-of-service line (dead busbar), where the synchronism condition is determined by the concurrence of the following conditions for the set t_{Ref} time:

1. the voltage of the active half-busbar is above threshold U_{live}
2. the voltage of the dead half-busbar is below threshold U_{dead}
3. the circuit-breaker is open.

In both cases, the synchronism signal is activated when the required conditions are reached and it remains active for at least 200ms. After this lapse of time, the consent signal is deactivated, if the synchronism conditions fail.

The indication of the synchronism reached is available directly as an electrical indication via a contact that is always provided with the module. This function can be activated simply by connecting the Ekip Synchrocheck module to any Ekip Touch device provided with an Ekip Measuring module.

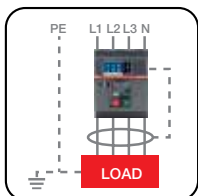

G ext – Ground fault on toroid

This is available only for the XT7, with a trip time which is independent of the current ($t = k$) or with a constant specific let-through energy ($t = k/I^2$). If the pre-alarm reaches a 90% threshold this permits the fault to be reported to supervision systems without any interruption of continuity. The protection needs an external toroid installed, for example, on the star center of the transformer, and is an alternative to the G and Rc functions. This device works with an auxiliary supply.

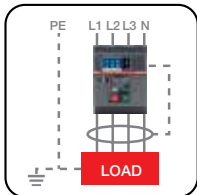

RC Residual current

This is available only for the XT7, with a constant time ($t=k$) and protects against indirect contacts and is integrated into the Ekip Touch LSIG with an Ekip Measuring with a dedicated residual current rating plug and external toroid. The protection is an alternative to the G and Gext functions.

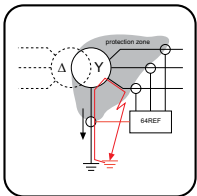

Second protection against ground fault

This is available only for the XT7. Whereas with the Ekip Touch, the user has to choose between implementation of the G type protection using internal current sensors (calculating the vector sum of the currents) or Gext external toroids (direct measurement of the ground fault current), the Ekip Hi-Touch offers the exclusive feature of simultaneous management of both configurations by two independent ground fault protection curves. Owing to this characteristic, the trip unit is able to distinguish a non-restricted from a restricted ground fault, and then activate the opening of the circuit-breaker and command the opening of the medium voltage circuit-breaker. Another possible configuration is with the residual current protection replacing the Gext protection, while the G protection remains active. The residual current protection is activated in the presence of the residual current rating-plug and of the toroid.

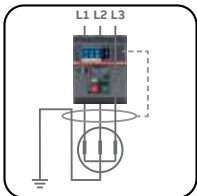

RC Differential ground fault protection against ground faults

Available on the XT7 only, this unit protects against internal ground faults on the generator windings. It is required that the toroid (additional accessory) embraces the active conductors and the ground conductor. RC protection is integrated via a dedicated residual current rating plug and an external toroid.

Ekip Touch/Hi-Touch

Additional protection functions

Additional protection functions:

Protection	Thermal memory	Trip Enable	Zone Selectivity	StartUp enable	Blocks	Directional Zone Selectivity
L	●					
S	●	●	●	●	●	
I				●	●	
G		●	●	●	●	
MCR					●	
IU		●				
T		●				
S2		●	●	●	●	
D				●		●
UV				●		
OV				●		
VU				●		
UF				●		
OF				●		
RP				●		
S(V)				●		
S2(V)				●		
RV				●		
RQ				●		
RQ2				●		
OQ				●		
OP				●		
UP				●		
ROCOF				●		
UV2		●			●	
OV2		●			●	
UF2		●			●	
OF2		●			●	
UP		●				
Gext		●	●			

Thermal memory

This function is used to protect components such as transformers and cables against overheating due to overloads. It adjusts the trip time of the protection according to the time elapsed after the first overload, taking account of the overheating caused. It can be activated when a $t = k/I^2$ (with an inverse long time) curve is used.

Trip Enable

The function enables the trip to be excluded so that only the alarm is indicated. This is used in installations where continuity of service is an essential requirement.

Zone Selectivity

The function allows multiple circuit-breakers belonging to the same installation to be connected together, in order to coordinate the trip units and to reduce the tripping times in the case of protections S, G and S2. Thus, in the event of a failure:

- the circuit-breaker closest to the fault trips
- the other circuit-breakers are locked for a programmable time.

Each circuit-breaker that detects a fault reports it to the circuit-breaker upstream; the circuit-breaker that detects the fault but does not receive any communication from those downstream opens without waiting for the set delay to elapse.

It is possible to enable zone selectivity if a fixed-time curve has been selected and the auxiliary supply is present.

StartUp Enable

The function modifies the threshold of the protection for a period that can be set by the user, avoiding unwanted trips due to high inrush currents of certain loads (motors, transformers, lamps). The starting phase lasts 100ms to 30s and is recognized automatically by the trip unit:

- at the closing of the circuit-breaker with a self-supplied trip unit;
- when the peak value of the maximum current exceeds the set threshold ($0.1...10 \times I_n$) with an externally supplied trip unit.

A new start-up is possible after the current falls below the threshold. This function can be activated with a fixed time protection function ($t = k$). Moreover, the I3 startup threshold must be higher than the I2 startup threshold.

Protection blocks

With the Ekip Connect software six blocks are available for some protections, which is useful for deactivating the protection based on programmable events. In particular:

- four blocks are associated with the programmable states A, B, C and D
- one block is associated with the start-up (present for protections that have a StartUp function);
- one block, not present for frequency protections, is associated with the checking the measured frequency.

Each block is independent and has its own activation command. The protection is deactivated for a time equal to the duration of the event itself:

- if the programmed event occurs (true), in the case of state-based blocks
- if the StartUp function is active and the start-up threshold is exceeded (the active block for the set start-up time), whenever the StartUp block function is enabled.
- if at least one frequency measured is outside the range 30...80 Hz, in the case of a frequency based block.

Directional Zone Selectivity

The Zone Selectivity function allows multiple circuit-breakers belonging to the same installation to be connected together in order to coordinate the trip units and reduce tripping times, but with some important differences:

- it is to be used in installations with a ring circuit
- it allows tripping to be managed and coordinated according to the power flows (determined by the direction of the current), in order to minimize dispersion of energy.

It works as an alternative to S and G Zone Selectivity.

Ekip Touch/Hi-Touch

Protection settings

Available settings for each protection function:

ABB Code	ANSI Code	Function	Threshold Range	Threshold Step
Protections				
L	49	Overload according to 60947-2	$I1 = 0.4...1 \times I_n$	$0.001 \times I_n$
	49	Overload according to 60255-151	$I1 = 0.4...1 \times I_n$	$0.001 \times I_n$
S	50 TD	Time-delayed overcurrent	$I2 = 0.6...10 \times I_n$	$0.1 \times I_n$
	68	Zone selectivity Start up	Activation: $0.6...10 \times I_n$	$0.1 \times I_n$
	51	Time-delayed overcurrent	$I2 = 0.6...10 \times I_n$	$0.1 \times I_n$
I	50	Instantaneous short-circuit	XT2-XT4-XT5: $I3 = 1.5...10 \times I_n$ XT7: $I3 = 1.5...15 \times I_n$	$0.1 \times I_n$
		Start up	Activation: XT2-XT4-XT5: $I3 = 1.5...10 \times I_n$ XT7: $I3 = 1.5...15 \times I_n$	$0.1 \times I_n$
G (1)	50N/50N TD	Earth fault	$I4 = 0.1...1 \times I_n$	$0.001 \times I_n$
	68	Zone selectivity Start up	Activation: $0.2...10 \times I_n$	$0.02 \times I_n$
	51N	Earth fault	$I4 = 0.1...1 \times I_n$	$0.001 \times I_n$
N		Neutral	On/Off	50%-100%-200% of the phases
2I	50	Programmable 2nd Instantaneous short-circuit	XT2-XT4-XT5: $I3 = 1.5...10 \times I_n$ XT7: $I3 = 1.5...15 \times I_n$	$0.1 \times I_n$
MCR		Closing on short-circuit	XT2-XT4-XT5: $I3 = 1.5...10 \times I_n$ XT7: $I3 = 1.5...15 \times I_n$	$0.1 \times I_n$
IU	46	Current unbalance	$I6 = 2...90\% I_n$ unbalance	1% I_n
LC1/2 Iw1/2	-	Current threshold Activation up/down	$LC1 = 50...100\% \times I1$	1%
			$LC2 = 50...100\% \times I1$	1%
			$Iw1 = 0.1...10 \times I_n$ $Iw1 = 0.1...10 \times I_n$	$0.01 \times I_n$
S2	50 TD	2nd Time-delayed overcurrent	$I2 = 0.6...10 \times I_n$	$0.1 \times I_n$
	68	Zone selectivity Start up	Activation: $0.6...10 \times I_n$	$0.1 \times I_n$
Phase Sequence	47	Cyclical direction of the phases	1-2-3 or 3-2-1	
UV	27	Undervoltage	$U8 = 0.5...0.98 \times U_n$	$0.001 \times U_n$
OV	59	Overvoltage	$U9 = 1.02...1.5 \times U_n$	$0.001 \times U_n$
UV2	27	2nd Undervoltage	$U15 = 0.5...0.98 \times U_n$	$0.001 \times U_n$
OV2	59	2nd Overvoltage	$U16 = 1.02...1.5 \times U_n$	$0.001 \times U_n$
VU	47	Voltage unbalance	$U14 = 2...90\% U_n$ unbalance	1% U_n
S(V)	51V	Voltage controlled overcurrent	$I20 = 0.6...10 \times I_n$	$0.1 \times I_n$
		Step mode (controlled mode)	$U1 = 0.2...1 \times U_n$ $Ks = 0.1...1$	$0.01 \times U_n$ 0.01
	51V	Linear mode (restrained mode)	$U1 = 0.2...1 \times U_n$ $Uh = 0.2...1 \times U_n$	$0.01 \times U_n$ $0.01 \times U_n$
			$Ks = 0.1...1$	0.01

Trip Time	Time Step	Excludability	Excludability trip	Pre-Allarm	Curve
XT2-XT4 : t1 = 3...60 s @ 3 x I1 XT5: t1 = 3...48 s @ 3 x I1 XT7: t1 = 3...144 s @ 3 x I1	1 s	no	no	50%...90% I1 step 1%	t = k/I ²
t1 = 3...144 s for XT7 t1 = 3...9 s for XT2-XT4-XT5 SI: k=0.14; α=0.02 VI: k=13.5; α=1 EI: k=80; α=2 SI: k=0.14; α=0.02 t = k / I4: k=80; α=4	1 s	no	no	50%...90% I1 step 1%	t = (k t1)/((if/I1)α-1)
XT2 - XT4 : t2 = 0.05...0.4 s XT5: t2 = 0.05...0.5 s XT7: t2 = 0.05...0.8 s	0.01 s	yes	yes	no	t = k
t2sel = 0.04...0.2 s @ 10 x In	0.01 s	yes			
Range: 0.1 ... 30s	0.01 s	yes			
XT2 - XT4 : t2 = 0.05...0.4 s @ 10 x In XT5: t2 = 0.05...0.5 s @ 10 x In XT7: t2 = 0.05...0.8 s @ 10 x In	0.01 s	yes	yes	no	t = k/I ²
Instantaneous		yes	no	no	t = k
Range: 0.1 ... 30s	0.01 s	yes			
t4 = Inst.0.1 ...1 s with I > I4	0.05 s	yes	yes	50%...90% I4 step 1%	t = k
t4sel = 0.04...0.2 s	0.01 s	yes			
Range: 0.1 ... 30s	0.01 s	yes			
t4 = 0.1...1 s	0.05 s	yes	yes	50%...90% I4 step 1%	t = k/I ²
		yes			
Instantaneous		yes	no	no	t = k
Instantaneous Monitor time range 40...500 ms	0.01 s	yes	no	no	t = k
t6 = 0.5...60 s	0.5 s	yes	yes	no	t = k
		yes	only signaling	no	
XT2 - XT4 : t2 = 0.05...0.4 s XT5: t2 = 0.05...0.5 s XT7: t2 = 0.05...0.8 s	0.01 s	yes	yes	no	t = k
t5sel = 0.04...0.2s	0.01 s	yes	yes		
Range: 0.1 ... 30s	0.01 s	yes			
		yes	only signaling	no	
t8 = 0.05...120 s	0.01 s	yes	yes	no	t = k
t9 = 0.05...120 s	0.01 s	yes	yes	no	t = k
t15 = 0.05...120 s	0.01 s	yes	yes	no	t = k
t16 = 0.05...120 s	0.01 s	yes	yes	no	t = k
t14 = 0.5...60 s	0.5 s	yes	yes	no	t = k
t20 = 0.05...30 s	0.01 s	yes	yes	no	t = k

Ekip Touch/Hi-Touch

Protection settings

ABB Code	ANSI Code	Function	Threshold Range	Threshold Step
Protections				
S2(V)	51V	2nd Voltage controlled overcurrent Step mode (controlled mode)	$I_{21} = 0.6...10 \times I_n$ $U_{I2} = 0.2...1 \times U_n$ $K_{s2} = 0.1...1$	$0.1 \times I_n$ $0.01 \times U_n$ 0.01
	51V	Linear mode (restrained mode)	$U_{I2} = 0.2...1 \times U_n$ $U_{h2} = 0.2...1 \times U_n$ $K_{s2} = 0.1...1$	$0.01 \times U_n$ $0.01 \times U_n$ 0.01
RV	59N	Residual overvoltage	$U_{22} = 0.05...0.5 \times U_n$	$0.001 \times U_n$
UF	81L	Underfrequency	$f_{12} = 0.9...0.999 \text{ fn}$	$0.001 \times \text{fn}$
OF	81H	Overfrequency	$f_{13} = 1.001...1.1 \text{ fn}$	$0.001 \times \text{fn}$
UF2	81L	2nd Underfrequency	$f_{17} = 0.9...0.999 \text{ fn}$	$0.001 \times \text{fn}$
OF2	81H	2nd Overfrequency	$f_{18} = 1.001...1.1 \text{ fn}$	$0.001 \times \text{fn}$
RP	32R	Reverse active power	$P_{11} = -1...-0.05 \text{ Sn}$	0.001 Sn
Cos ϕ	78	Power factor	$\text{Cos } \phi = 0.5...0.95$	0.01
D	67	Directional overcurrent	$I_{7 \text{ Fw/Bw}} = 0.6...10 \times I_n$	$0.1 \times I_n$
	68	Zone selectivity Start up Minimum angle of direction (°)	Activation: $0.6...10 \times I_n$ 3.6, 7.2, 10.8, 14.5, 18.2, 22, 25.9, 30, 34.2, 38.7, 43.4, 48.6, 54.3, 61, 69.6	$0.1 \times I_n$
RQ	40/32R	Loss of field or reverse reactive power	$Q_{24} = -1...-0.1 \times \text{Sn}$ $K_q = -2...2$	$0.001 \times \text{Sn}$ 0.01
		Loss of field or reverse reactive power	$Q_{25} = -1...-0.1 \times \text{Sn}$ $K_q = -2...2$	$0.001 \times \text{Sn}$ 0.01
		Minimum voltage threshold	$V_{\text{min.}} = 0.5...1.2$	0.01
OQ	320F	Reactive overpower	$Q_{27} = 0.4...2 \times \text{Sn}$	$0.001 \times \text{Sn}$
OP	320F	Active overpower	$P_{26} = 0.4...2 \times \text{Sn}$	$0.001 \times \text{Sn}$
UP	32LF	Active underpower StartUp	$P_{23} = 0.1...1 \times \text{Sn}$	$0.001 \times \text{Sn}$
ROCOF	81R	Rate of change of frequency	$f_{28} = 0.4...10 \text{ Hz / s (up \&/or down)}$	0.2 Hz/s
L (Motor Protection)		Motor protection overload According 60947-4-1	$I_1 = 0.4...1 \times I_n$	$0.001 \times I_n$
R	51R	Rotor blockage - Jam	$I_j = 2...10 \times I_1$	0.1
	51R	Rotor blockage - Stall	$I_s = 1...10 \times I_1$	0.1
U		Phase lackand/or unbalance	On/Off	-
Un	46	Phase unbalance	$20...50\% \times I_1$	10%
Uc	37	Undercurrent	$50...90\% \times I_1$	10%
Protection with additional modules				
SC Synchrocheck	25	Synchrocheck (Live busbars)	$U_{\text{live}} = 0.5...1.1 \times U_n$ $\Delta U = 0.02...0.12 \times U_n$ $\Delta f = 0.1...1 \times \text{Hz}$ $\Delta \Phi 5...50^\circ \text{ elt}$	$0.001 \times U_n$ $0.001 \times U_n$ $0.1 \times \text{Hz}$ 5° elt
		Synchrocheck (Live. Dead busbars)	$U_{\text{live}} = 0.5...1.1 \times U_n$ $U_{\text{dead}} = 0.02...0.2 \times U_n$	$0.001 \times U_n$ $0.001 \times U_n$
		Frequency check off		
		Phase check off		
		Dead bar configuration	Reverse/Standard	
		Primary voltage	100...1150	100, 115, 120, 190, 208, 220, 230, 240, 277, 347, 380, 400, 415, 440, 480, 500, 550, 600, 660, 690, 910, 950, 1000, 1150
		Secondary voltage	100...120	100, 110, 115, 120
Gext⁽¹⁾	50G TD	Earth fault	$I_4 = 0.1...1 \times I_n \text{ toroid}$	$0.001 \times I_n \text{ Toroid}$
	68	Zone selectivity Start up	Activation: $0.1...1 \times I_n$	$0.02 \times I_n$
	51G	Earth fault	$I_4^{(1)} = 0.1...1 \times I_n$	$0.001 \times I_n$
Rc	64 50N TD 87N	Residual current / Differential ground fault	$I_{\Delta n} = 3 - 5 - 7 - 10 - 20 - 30A$	

All the protection functions can be excluded if needed except for L, I, MCR. The RC for the XT7 is active only when the rating plug is present. All of the Synchrocheck functions are for signaling. An adjustable pre-alarm threshold ($50...90\% I_1$) is available for L protection, as well as a fixed pre-alarm threshold is available for G and Gext protection.

Trip Time	Time Step	Excludability	Excludability trip	Pre-Allarm	Curve
t21 = 0.05...30 s	0.01 s	yes	yes	no	t = k
t22 = 0.5...120 s	0.01 s	yes	yes	no	t = k
t12 = 0.15...300 s	0.01 s	yes	yes	no	t = k
t13 = 0.15...300 s	0.01 s	yes	yes	no	t = k
t17 = 0.15...300 s	0.01 s	yes	yes	no	t = k
t18 = 0.15...300 s	0.01 s	yes	yes	no	t = k
t11 = 0.5...100 s	0.1 s	yes	yes	no	t = k
t7 Fw/Bw = 0.2...0.8 s	0.01 s	yes	yes	no	t = k
t7sel = 0.13...0.5s	0.01 s	yes	only signaling	no	
Range 0.1...0.8s	0.01 s	yes			
t24 = 0.5...100 s	0.1 s	yes	yes	no	t = k
t24 = 0.5...100 s	0.1 s	yes	yes	no	t = k
t27 = 0.5...100 s	0.5 s	yes	yes	no	t = k
t26 = 0.5...100 s	0.5 s	yes	yes	no	t = k
t23 = 0.5...100 s	0.5 s	yes	yes	no	t = k
Range from closing: 0.1...30S or with digital input	0.01 s	yes			-
t28 = 0.5...10 s for f>f28	0.01 s	yes	yes	no	t = k
XT2-XT4: 3E - 5E - 10E - 20E					t = k/I ²
XT5-XT7: 5E - 10E - 20E - 30E					
tj = 1...10 s	0.5 s				t = k
ts = 2...10 s	0.5 s				t = k
tu = 1...10 s	0.5 s				t = k
tun = 1...10 s	0.5 s				t = k
tuc = 1...20 s	0.5 s				t = k
Stability voltage time for live state = 100...30000ms	0.001 s	yes	only signaling	no	
Minimum matching time = 100...3000ms	0.01 s				
tref = 0.1...30 s	0.1 s	yes	only signaling	no	
		yes			
		yes			
		yes			
t4 = 0.1...1 s	0.05 s	yes	yes	50...90% I41 step 1%	t = k
t41sel = 0.04...0.2 s	0.01 s	yes			
Range: 0.1...30s	0.01 s	yes			
t4 = 0.1...1 s with I = 4 x In	0.05 s	yes	yes	50...90% I41 step 1%	t = k/I ²
tΔn = 0.06 - 0.1 - 0.2 - 0.3 - 0.4 - 0.5 - 0.8 s			no	no	t = k

Ekip Touch/Hi-Touch

Tolerances

ABB Code	ANSI Code	Function	Threshold Range	Trip Time
Protections				
L	49	Overload according to 60947-2	trip between 1.05 and 1.2 x I1	± 10% I ≤ 6 x In ± 20% I ≥ 6 x In
	49	Overload according to 60255-151	trip between 1.05 and 1.2 x I1	± 10% I ≤ 6 x In ± 20% I ≥ 6 x In
S	50 TD	Selective short-circuit	± 7% I ≤ 6 x In ± 10% I ≥ 6 x In	The better of the two data: ± 10% or ± 40ms
	51	Selective short-circuit	± 7% I ≤ 6 x In ± 10% I ≥ 6 x In	± 15% I ≤ 6 x In ± 20% I ≥ 6 x In
I	50	Instantaneous short-circuit	± 10%	≤ 30ms
G ⁽¹⁾	68	Earth Fault	± 7%	The better of the two data: ± 10% or ± 40ms with t4=instantaneous
	51N	Earth Fault	± 7%	± 15%
2I	50	2nd Instantaneous short-circuit	± 10%	≤ 30ms
MCR		Closing on short-circuit	± 10%	≤ 30ms
IU	46	Current unbalance	10%	The better of the two data: ± 10% or ± 40ms (for t5 < 5s) / ± 40ms (for t5 ≥ 5s)
LC1/2 - Iw1/2		Current threshold	± 10%	
S2	68	2nd Selective short-circuit	± 7% I ≤ 6 x In ± 10% I ≥ 6 x In	The better of the two data: ± 10% or ± 40ms
UV	27	Undervoltage	± 2%	The better of the two data: ± 10% or ± 40ms (for t5 < 5s) / ± 40ms (for t5 ≥ 5s)
OV	59	Overvoltage	± 2%	The better of the two data: ± 10% or ± 40ms (for t5 < 5s) / ± 40ms (for t5 ≥ 5s)
UV2	27	2nd Undervoltage	± 2%	The better of the two data: ± 10% or ± 40ms (for t5 < 5s) / ± 40ms (for t5 ≥ 5s)
OV2	59	2nd Overvoltage	± 2%	The better of the two data: ± 10% or ± 40ms (for t5 < 5s) / ± 40ms (for t5 ≥ 5s)
VU	47	Voltage unbalance	± 5%	The better of the two data: ± 10% or ± 40ms (for t5 < 5s) / ± 40ms (for t5 ≥ 5s)
S(V)	51V	Voltage controlled overcurrent	± 10%	The better of the two data: ± 10% or ± 40ms (for t5 < 5s) / ± 40ms (for t5 ≥ 5s)
S2(V)	51V	2nd Voltage controlled overcurrent	± 10%	The better of the two data: ± 10% or ± 40ms (for t5 < 5s) / ± 40ms (for t5 ≥ 5s)
RV	59N	Residual overvoltage	± 5%	The better of the two data: ± 10% or ± 40ms (for t5 < 5s) / ± 40ms (for t5 ≥ 5s)
UF	81L	Underfrequency	± 1% (with fn ± 2%)	The better of the two data: ± 10% or ± 40ms (for t5 < 5s) / ± 40ms (for t5 ≥ 5s)
OF	81H	Overfrequency	± 1% (with fn ± 2%)	The better of the two data: ± 10% or ± 40ms (for t5 < 5s) / ± 40ms (for t5 ≥ 5s)
UF2	81L	2nd Underfrequency	± 1% (with fn ± 2%)	The better of the two data: ± 10% or ± 40ms (for t5 < 5s) / ± 40ms (for t5 ≥ 5s)
OF2	81H	2nd Overfrequency	± 1% (with fn ± 2%)	The better of the two data: ± 10% or ± 40ms (for t5 < 5s) / ± 40ms (for t5 ≥ 5s)

ABB Code	ANSI Code	Function	Threshold Range	Trip Time
RP	32R	Reverse active power	± 10%	The better of the two data: ± 10% or ± 40ms (for t5<5s) / ± 40ms (for t5 ≥ 5s)
D	68	Directional overcurrent	± 7% I ≤ 6 x I _n ± 10% I ≥ 6 x I _n	If t7 ≤ 200 ms : +/-20 ms If 200ms < t7 ≤ 400 ms : 10% If con t7 > 400 ms : 40 ms
RQ	40/32R	Loss of field or reverse reactive power	± 10%	The better of the two data: ± 10% or ± 40ms (for t5<5s) / ± 40ms (for t5 ≥ 5s)
OQ	320F	Reactive overpower	± 10%	The better of the two data: ± 10% or ± 40ms (for t5<5s) / ± 40ms (for t5 ≥ 5s)
OP	320F	Active overpower	± 10%	The better of the two data: ± 10% or ± 40ms (for t5<5s) / ± 40ms (for t5 ≥ 5s)
UP	32LF	Active underpower	± 10%	The better of the two data: ± 10% or ± 40ms (for t5<5s) / ± 40ms (for t5 ≥ 5s)
ROCOF	81R	Rate of change of frequency	± 5%	The better of the two data: ± 10% or ± 40ms
L (Motor Protection)		Motor protection overload According 60947-4-1		
R	51LR	Rotor blockage - Jam	I _j = 2...10 x I _l	t _j = 1...10 s
	51LR	Rotor blockage - Stall	I _s = 1...10 x I _l	t _s = 2...10 s
U				
Un	46			
Uc	37			
Protection with additional modules				
SC Synchrocheck	25	Synchrocheck (Live busbars)	10%	
		Synchrocheck (Live. Dead busbars)	10%	
Gext ⁽¹⁾	68	Earth fault	± 7%	The better of the two data: ± 10% or ± 40ms
	51G	Earth fault	± 7%	± 15%
	51G	Earth fault		
Rc	64 50N TD	Residual current / Differential ground	- 20% ÷ 0%	140ms @ 0.06s (max trip time)
	87N	fault		950ms @ 0.80s (max trip time)

(1) With Vaux all thresholds are available. Without Vaux the minimum threshold is limited to: 0.3 x In for XT2 and XT4 with In ≤ 100A; 0.25 for XT5 with In ≤ 320A; 0.2 x In for all the other ratings.

The tolerances above apply to trip units already powered by the main circuit with current flowing in at least two phases or an auxiliary power supply. In all other cases the following tolerance values apply:

ABB Code	Trip threshold	Trip time
L	Trip between 1.05 and 1.2 x I _l	± 20%
S	± 10%	± 20%
I	± 15%	≤ 60ms
G	± 15%	± 20%
Other protection	± 15%	± 20%

Ekip Touch/Hi-Touch

Measurement functions and data

Currents

All the Ekip Touch/Hi-Touch trip units measure the RMS value of the instantaneous currents of the three phases and the neutral. There are two different levels of accuracy depending on the version (0.5% and 1%). In addition, also the minimum and maximum values recorded within an adjustable time interval are available.

Voltage

Instantaneous phase-to-phase and phase-to-neutral voltages can be measured. They are available at a 0.5% level of accuracy. In addition, the minimum and maximum values recorded within an adjustable time interval are available.

Power

Real time measurements of the total and phase power. Available at 2 different level of accuracy depending on the version, 1 % and 2%. In addition, the minimum and maximum values recorded within an adjustable time interval are available.

Energy meters

Measurements of the active, reactive and apparent energy totals, updated every minute. The measurements can be reset when needed.

Frequency

Measurement of line real time frequency, expressed in hertz.

Peak Factor

Real time measurements of the peak factors of the phase currents. The measurements are expressed as a ratio between the peak values and RMS values, for each single phase.

Power Factor

Power factor and real time measurements of the ratio between the total active power and total apparent power, expressed as $\cos\varphi$. In addition, the trip unit signals an alarm if the $\cos\varphi$ value drops below an adjustable threshold, settable via Ekip Connect software (from 0.5 to 0.95).

Datalogger

This function allows the data related to a trigger event to be recorded. These data are:

- Analog measurements: phase currents and phase-to-phase voltages
- Digital events: protection alarms, circuit-breaker status signals, tripping of protections.

When the datalogger is activated, the trip unit continuously acquires data by filling and emptying an internal register. If a trigger event occurs, the trip unit inhibits acquisition (either immediately or with an adjustable time-lag) and stores the data, which is available for downloading.

Network Analyzer

This function fully evaluates the quality of the network. It is possible to set the controls to long cycle voltage and current in order to analyze the system functionality. Voltages and currents are monitored to find:

- The sequence of voltages
- Short term voltage drops or interruptions
- Short duration voltage increases
- Slow voltage drops
- Slow voltage increases
- Unbalances between the voltages
- Harmonic distortion of voltages and currents.

Waveforms

A selected quantity can be represented as a waveform and acquired at the moment of selection.

The phase current and phase-phase voltage can be displayed.

Harmonics

A representation in the form of a histogram of the measurements of the harmonics that make up the waveform, and related to the frequency set.

Operation counter

In the presence of a power supply, the trip unit records information about the openings of the circuit-breaker including:

- the number of manual openings
- the total number of operations (manual + trips).

By activating communication with the trip unit, the following parameters are also available:

- the number of openings due to protection tripping
- the number of openings for which tripping has not been completed in due time (back-up commands have been necessary)
- the number of opening tests performed.

Contact wear

This gives an estimation of the conditions of the main circuit-breaker contacts. The value is expressed as a percentage, and is 0% in case of no wear, and 100% in case of total wear. This is calculated automatically by the trip unit at every opening for protection or, in the presence of a power supply, also at every manual opening of the circuit-breaker.

Openings

Information about the last 30 openings are available. In particular:

- tripped protection
- the progressive number of the opening
- the date and time of the opening (referred to the internal clock)
- measurements associated with the trip protection.





The most recent opening is viewable also by pressing the iTest key.

Events

The last 200 events are recorded. The following information is available:

- trip unit: configuration status of the bus, operating mode, active set, auxiliary power supply
- protections: delay in action or alarms
- connection states or alarms: circuit-breaker, current sensors, trip coil, rating plug
- tripping: state of the opening command, or signal of tripping for protection.

The icons help to quickly understand the type of event:

-  event reported for information purposes
-  delay of a protection in progress, trip expected
-  alarm referring to a non-hazardous condition
-  alarm for operation, failure, or connection fault.

Synchrocheck

Synchrocheck measurements relating to the function of synchronism between two independent power sources.

Ekip Touch/Hi-Touch

Measurement functions and data

The parameters measurable for each trip unit are shown in the following tables. Three different software packages are available to upgrade the trip units:

- Measuring package for measurement of voltage, power and energy
- Datalogger for data record
- Network Analyzer for the evaluation of the power quality.

Instantaneous measurements		Ekip Touch	Ekip Touch Measuring	Ekip Hi-Touch	Ekip M Touch	Ekip G Touch	Ekip G Hi-Touch
Currents (RMS)	L1, L2, L3, Ne	[A] ●	●	●	●	●	●
Ground fault current (RMS)	I _g	[A] ●	●	●	●	●	●
Measuring package			●	●	●	●	●
Phase-phase voltage (RMS)	U ₁₂ , U ₂₃ , U ₃₁	[V] ○	●	●	●	●	●
Phase-neutral voltage (RMS)	U ₁ , U ₂ , U ₃	[V] ○	●	●	●	●	●
Phase sequence		○	●	●	●	●	●
Frequency	f	[Hz] ○	●	●	●	●	●
Active power	P ₁ , P ₂ , P ₃ , P _{tot}	[kW] ○	●	●	●	●	●
Reactive power	Q ₁ , Q ₂ , Q ₃ , Q _{tot}	[kVAR] ○	●	●	●	●	●
Apparent power	S ₁ , S ₂ , S ₃ , S _{tot}	[KVA] ○	●	●	●	●	●
Power factor	PF ₁ , PF ₂ , PF ₃ , PF total	○	●	●	●	●	●
Peak factor	total	○	●	●	●	●	●
Counters: recorded from installation or from the last reset							
Active energy	Ep total, Ep positive, Ep negative	[kW] ○	●	●	●	●	●
Reactive energy	Eq total, Ep positive, Ep negative	[kVAR] ○	●	●	●	●	●
Apparent energy	Es total	[KVA] ○	●	●	●	●	●

● Available as standard

○ Available as software package to be ordered via ABB Ability Marketplace™ or during the circuit-breaker ordering phase

Depending on the need two different accuracy levels are available for the trip unit, the Standard Precision and High Precision certified according to IEC 61557-12:

Instantaneous measurements		Standard Precision	High Precision certified according to IEC 61557-12
Currents (RMS)	[A] L1, L2, L3, Ne	1%	0.50%
Ground fault current (RMS)	[A] I _g	2%	0.50%
Phase-phase voltage (RMS)	[V] U ₁₂ , U ₂₃ , U ₃₁	0.50%	0.50%
Phase-neutral voltage (RMS)	[V] U ₁ , U ₂ , U ₃	0.50%	0.50%
Frequency	[Hz] f	0.20%	0.20%
Active power	[kW] P ₁ , P ₂ , P ₃ , P _{tot}	2%	1%
Reactive power	[kVAR] Q ₁ , Q ₂ , Q ₃ , Q _{tot}	2%	2%
Apparent power	[KVA] S ₁ , S ₂ , S ₃ , S _{tot}	2%	1%
Power factor	PF ₁ , PF ₂ , PF ₃ , PF total	2%	1%
Active energy	[kW] E _p total, E _p positive, E _p negative	2%	1%
Reactive energy	[kVAR] E _q total, E _q positive, E _q negative	2%	2%
Apparent energy	[KVA] E _s total	2%	1%

The lowest current value that the trip units Ekip Touch/Hi-Touch can measure is 0,004 x I_n

High Precision certified according to IEC 61557-12

Available only for factory assembled circuit-breakers, this accuracy is available as default on the Ekip Hi-Touch and Ekip G Hi-Touch trip units, anyway it is always possible to have this accuracy for the other Ekip Touch trip units by adding when ordering the dedicated commercial codes.

For XT2 Ekip Touch trip units the High Precision is available in general for I_n ≥ 100A

Ekip Touch/Hi-Touch

Measurement functions and data

Network Analyzer		Interval
Hourly average voltage value	[V] [no] - U _{min} = 0.75...0.95 x U _n - U _{max} = 1.05...1.25 x U _n - Events counter ⁽¹⁾	t = 5...120min
Short voltage interruptions	[no] - U _{min} = 0.75...0.95 x U _n - Events counter ⁽¹⁾	t < 40ms
Short voltage spikes	[no] - U _{max} = 1,05...1,25 x U _n - Events counter ⁽¹⁾	t < 40ms
Slow voltage sags and swells	[no] - U _{min1} = 0.75...0.95 x U _n - U _{min2} = 0.75...0.95 x U _n - U _{min3} = 0.75...0.95 x U _n - U _{max1} = 1.05...1.25 x U _n - U _{max2} = 1.05...1.25 x U _n - Events counter ⁽¹⁾	t = 0.02s...60s
Voltage unbalance	[V] [no] - U neg. seq.= 0.02...0.10 x U _n - Events counter ⁽¹⁾	t = 5...120min
Harmonic analysis	Current and Voltage - up to 50° - Alarm THD: 5...20% - Single harmonic alarm: 3...10% plus a count of minutes the harmonic has been exceeded	
Record of values: for each interval with time-stamping	Parameters	Window & interval
Current: minimum and maximum	[A] I Min, I Max	Fixed synchronizable by remote
Phase-to-phase voltage: minimum and maximum	[V] U Min, U max	Duration: 5...120min
Active power: average and maximum	[kW] P Mean, P Max	Number of intervals: 24
Reactive power: average and maximum	[kVAR] Q Mean, Q Max	
Apparent power: average and maximum	[KVA] S Mean, S Max	
Data logger: high rate sampling record of parameters	Parameters	
Currents	[A] L1, L2, L3, Ne, Ig	Fixed synchronizable by remote
Voltages	[V] U12, U23, U31	
Sampling rate	[Hz] 1200-9600	Duration: 5...120min
Maximum recording duration	[s] 18	Number of intervals: 24
Recording stop delay	[s] 0-10s	
Number of registers	[no] 2 independent	
Info on trip & opening data: after a fault without auxiliary supply	Parameters	
Type of protection tripped	eg. L, S, I, G, UV, OV	
Fault values per phase	[A/V/Hz w/VAR] eg. I1, I2, I3, neutral for S protection V12, V23, V32 for UV protection	
Time-stamping	Date, time and progressive number	
Maintenance indicators	Parameters	
Information on last 30 trips	Type of protection, fault values and time-stamping	
Information on last 200 events	Type of event, time-stamping	
Number of mechanical operations	can be associated to alarm	
Total number of trips	[no]	
Total operating time	[no]	
Wear of contacts	[h] Pre-alarm >80% Alarm = 100%	
Date of maintenance operations performed	[%] Last	
Indication of maintenance operation needed		
Circuit-breaker I.D.	Type of circuit-breaker, assigned device name, serial number	
Self-diagnosis	Parameters	
Check of continuity of internal connections	Alarm due to disconnection: rating plug, sensors, trip coil	Note: Opening of the circuit-breaker
Failure of circuit-breaker to open (ANSI 50BF)	Alarm following non-tripping of protection functions	can be set in the event of alarm
Temperature (OT)	Pre-alarm and alarm for abnormal temperature	

● Available as standard

○ Available as software package to be ordered via ABB Ability Marketplace™ or during the circuit-breaker ordering phase. To add this function, the Measuring package must be installed first.

Communication and connectivity

- 4/2** **Introduction**
- 4/4** **Switchgear compartment**
 - Electrical switchgear**
 - 4/6** Remote communication
 - 4/8** Ekip Control Panel & Ekip Link
- Electrical system**
- 4/10** Software applications
- 4/12** Ekip Connect
- 4/14** Ekip view
- 4/16** **Software and web application**
- 4/18** **Accessories for Ekip Touch trip units**
- 4/27** **Accessories for electronic trip units**
- 4/28** **Accessories for XT2-XT4 Ekip trip units**

Introduction

The Tmax XT circuit-breakers are fully ready for Industry 4.0 requirements. The increasing number of connected objects and people is transforming electrical installation systems, bringing forward new potential in efficiency and productivity.

The Ekip Touch trip unit series can be connected in several ways to different networks and systems. According to their complexity, the supervision of low-voltage systems may involve different levels. Depending on where the supervision is needed, different communication configurations are available.

Switchgear compartment: control of the main electrical values of the circuit-breaker and set the protection functions, thanks to:

- embedded display of the trip units
- Ekip Multimeter display connected to the trip unit
- smartphone connection via embedded Bluetooth.

Electrical switchgear: display of the data of all circuit-breakers installed in the switchgear from a single point:

- locally via Ekip Control Panel on the front of the switchgear, collecting data from all the circuit-breakers and other devices of the switchboard
- remotely via several communication protocols.

Electrical system: management of complex systems in which the devices must be integrated in automated industrial processes or in intelligent electrical networks, better known as smart grids. The system can be supervised by:

- Ekip View software
- Internet with the ABB Ability™ Electrical Distribution Control System webapp.





For all the possible supervision modes, connectivity modules are necessary. Two mounting solutions are possible, one excluding the other:

- **Internally**, it is possible to mount the Ekip Com modules in the circuit-breaker.

This solution can be used on XT2, XT4 and XT5 circuit-breakers. The module is mounted directly inside the circuit-breaker with no additional space needed in the switchboard.

For this configuration, dedicated internal module codes are available.

- **Externally**, through the Ekip Cartridge. The modules can be installed inside the cartridge, which is directly connected to the trip unit by a cable. Available with the XT2, XT4 and XT5 sizes. The Ekip cartridge is available in two versions depending on how many modules are needed.

The solution with the external cartridge permits a double or even triple communication channel, as well as redundant communication. Besides, the cartridge solution makes it possible the use of advanced functions, such as Synchro Reclosing, embedded ATS and more.

When an internal module is used, the Ekip Cartridge cannot be used and vice versa.

To be highlighted that, for the XT7 and XT7 M sizes, the modules must be installed directly on the terminal box available on the upper part of the circuit-breaker. The modules are the same of the Ekip Cartridge. On the upper part of the circuit-breaker it is possible to install one Ekip Sup- plus maximum two additional modules.

Switchgear compartment

Display solutions

—
For the list of information available for each trip unit, see Chapter 3.

—
SACE Tmax XT circuit-breakers equipped with Ekip Touch electronic trip units enable electrical measurements and diagnostic data to be displayed on the front of the switchgear.

Solution with Ekip Touch trip units display

The Ekip Touch electronic trip units are the ideal solution for supervision and control of the compartments inside a switchgear. In detail:

- their use is simple and intuitive thanks to an embedded front display with push buttons on XT2 and XT4 sizes and a high resolution color touch screen display on XT5, XT7 and XT7 M sizes
- they do not require an auxiliary power supply for safety; the Ekip Touch trip units are directly supplied by the current sensors integrated in the circuit-breaker, thereby avoiding the use of external power supplies.

—
The Ekip Multimeter is a display unit to be installed on the front of the switchgear for SACE Tmax XT molded case circuit-breakers equipped with Ekip Touch electronic trip units.

Solution with Ekip Multimeter Display on the front of the switchgear

This device displays information about the system available in the trip unit to which it is connected and enables the adjustment of the parameters and protection thresholds.

The main characteristics of the Ekip Multimeter unit are:

- **Graphical and functional uniformity with the Ekip Touch trip units:** the Ekip Multimeter uses the same display as the trip unit to which it is connected, ensuring perfect continuity between the graphic display and the menu items.
- **Reduced dimensions:** the Ekip Multimeter guarantees the precision of the trip unit to which it is connected and performs the function of a measuring instrument without requiring the installation of external current and voltage transformers.
- **Flexible installation:** the Ekip Multimeter can be installed at a distance from the trip unit, enabling access to information from the most convenient point.
- **Simultaneous reading of the various electrical values:** the advanced connection system used allows several Ekip Multimeter devices to be connected to the same protection trip unit.

—
Embedded Bluetooth for a quick and wireless connection to your smartphone.

Solution with a smartphone connected via Bluetooth to the trip unit thanks to EPiC

Via the EPiC App, it is possible to:

- check and modify the protection functions settings
- read the measurements available on the trip unit
- buy the functions to upgrade the trip unit from the ABB Ability Marketplace™ and enable them directly on the trip unit
- download and share test reports of the trip unit.



- 01 Ekip Touch
- 02 Ekip Multimeter
- 03 EPiC

Ekip Touch trip unit	Integrated display	Ekip Multimeter	Smartphone with EPiC
Measurement functions			
Currents	●	●	●
Voltages	○	○	○
Powers	○	○	○
Energies	○	○	○
Harmonics	○	○	○
Network analyzer	○	○	○
Adjustment functions			
Setting of thresholds	●	●	●
Setting second set thresholds	○	○	○
Resetting of alarms	●	●	●
Upgrade of the trip unit functions			
Purchase of functions			●
Installation of function			●
Diagnostics			
Protection function alarms	●	●	●
Device alarms	●	●	●
Protection unit tripping details	●	●	●
Events log	●	●	●
Protection unit tripping log	●	●	●
Maintenance			
Number of operations	●	●	●
Number of trips	●	●	●
Contact wear	●	●	●
Other data			
Status of circuit-breaker	●	●	●
Local/remote mode	●	●	●

● Default available
○ Available depending on the trip unit

Electrical switchgear

Remote communication

The integration of low-voltage devices in communication networks is required in particular for: automated industrial processes, industrial and petrochemical sites, modern data centers and intelligent electricity networks, better known as smart grids.

Ekip Com Modules

Thanks to the wide range of communication protocols supported, SACE Tmax XT circuit-breakers equipped with Ekip Touch electronic trip units can be integrated into communication networks without the need for external interface devices. The distinctive characteristics of the SACE Tmax XT circuit-breakers offering for industrial communication are:

- A wide range of protocols are supported; the Ekip Com communication modules enable integration with the most common communication protocols based on RS485 serial lines and the most modern communication systems based on EtherNet™ infrastructures, which guarantee an exchange of data in the order of 100 Mbit/s.

- Installation times are reduced to a minimum due to the plug & play technology of the communication modules, which are connected directly to the circuit-breaker terminal box for XT7 and XT7 M and to the Ekip Cartridge with XT2, XT4 and XT5.
- Installation space is reduced thanks to the ability to install the communication modules directly inside the circuit-breaker for XT2, XT4 and XT5.
- Redundancy of communication for greater reliability of the system; the circuit-breaker can be equipped with two communication modules at the same time, allowing the information on the buses to be exchanged simultaneously.
- Ready for the smart grid; the Ekip Com 61850 module is the solution for integrating SACE Tmax XT circuit-breakers into the automated systems of electrical substations based on the IEC 61850 Standard without the need for complex external devices.
- Complete supervision of Modbus RTU or Modbus TCP/IP networks via the software for PC Ekip View.

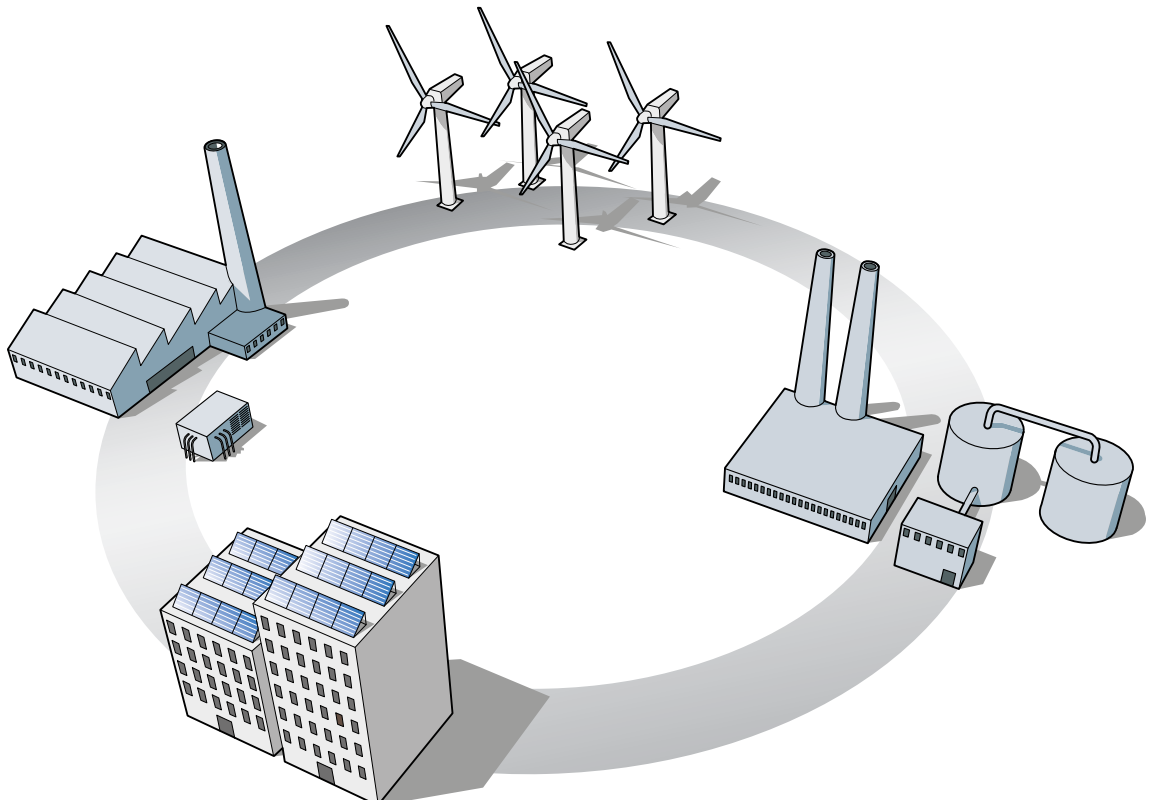

Supervision of the electrical installation	
Electronic trip unit	Ekip Touch trip units
Solution	Ekip Touch trip units + Ekip com modules
Protocols supported:	
Modbus RTU	Ekip com Modbus RTU
Profibus-DP	Ekip com Profibus
DeviceNet™	Ekip com DeviceNet™
Modbus TCP/IP	Ekip com Modbus TCP
Profinet	Ekip com Profinet
EtherNet/IP™	Ekip com EtherNet™
IEC61850	Ekip com IEC61850
Hub	Ekip com Hub
Control functions	
Circuit-breakers opening and closing ¹⁾	●
Measurement functions	
Currents	●
Voltages	○
Powers	○
Energies	○
Harmonics	○
Network analyzer	○
Data logger	○
Adjustment functions	
Setting thresholds	●
Resetting of alarms	●
Diagnostics	
Protection function alarms	●
Device alarms	●
Protection unit tripping details	●
Events log	●
Protection unit tripping log	●
Maintenance	
Number of operations	●
Number of trips	●
Contact wear	●
Other data	
Status of circuit-breaker	●
Local/remote mode	●

1) Circuit-breakers equipped with MOE-E for the XT2-XT4-XT5 or the Ekip Com Actuator module, or electrical accessories, opening and closing coils and spring charging motor in the case of the XT7-XT7 M. For details, ask ABB.

● Default available

○ Available depending on the trip unit

Ekip E-Hub

This is a DIN-rail mounted communication module for cloud-connectivity. The Ekip E-Hub can collect data throughout the system from air circuit-breakers to molded case circuit-breakers, multimeters, miniature circuit-breakers.

Moreover, it is possible to connect sensors for environmental parameters (temperature, water, gas) via both analog and digital I/O. Modules for Wi-Fi or GPRS connection are provided as optional features.

Electrical switchgear

Ekip Control Panel & Ekip Link

The Ekip Link is a flexible and efficient solution for controlling and supervising low-voltage electrical switchgear.

It is a system that enables SACE Tmax XT circuit-breakers to be connected to the Ekip Control Panel by means of Ekip Link interface modules.

Ekip Link system

The main characteristics of the Ekip Link System are:

- centralized control: from the Ekip Control Panel display all the main values of the installation (electrical measurements, system diagnostics and trends) can be monitored and controlled.
- integrated modules: Ekip Link is available also as an internal module, to save space and additional cabling.
- access via the Internet with any Internet browser using the web server function from the Ekip Control Panel.

- rapid installation, through the use of standardized EtherNet™ components such as STP cables and RJ45 type connectors.
- ease of use: thanks to the Ekip Control Panel with a color touch screen, the system mimic panel can be displayed so that the entire installation can be controlled rapidly and intuitively.
- ready to use: the Ekip Control Panel is supplied with pre-configured software that requires no programming. Just start scanning the Ekip Link system from the operator panel and in a few seconds communication with the connected devices is active.

Ekip Link enables supervision of electrical switchgear with up to 30 ABB circuit-breakers installed. Tmax T and Tmax XT series circuit-breakers equipped with Modbus RTU communication can also be easily integrated into the Ekip Link system using the multi-serial port fitted on the Ekip Control Panel.



Electronic trip unit	Ekip Dip	Ekip Touch
Solution	Ekip protection trip units equipped with Ekip Link module + Ekip Control Panel + Standard EtherNet™ components	
Type of trip units connectable	Ekip protection trip units	
Number of trip units connectable to the Ekip Link system	up to 30 ¹⁾	
Data exchange rate of Ekip Link system	100 Mbit/sec	
Supervision and control functions		
Opening and closing of circuit-breakers ²⁾	●	●
Electrical value trends		○
Log of electrical value trends		○
Dynamic installation mimic panel	•	○
Automatic scanning of the Ekip link system	•	○
Centralized synchronizing of time	•	○
Web server function	● ³⁾	● ³⁾
Measurement functions		
Currents	●	●
Voltages	-	○
Powers	-	○
Energies	-	○
Harmonics	-	○
Network analyzer	-	○
Data logger	-	●
Adjustment functions		
Setting thresholds	-	●
Resetting of alarms	●	●
Diagnostics		
Protection function alarms	●	●
Device alarms	●	●
Protection unit tripping details	●	●
Events log	●	●
Protection unit tripping log	●	●
Transmission of alarms via text message	optional	optional
Transmission of alarms via e-mail	optional	optional
Maintenance		
Number of operations	●	●
Number of trips	●	●
Contact wear	●	●
Other data		
Status of circuit-breaker	●	●
Local/remote mode	●	●

1) Circuit-breakers are equipped with MOE-E for the XT2-XT4-XT5 or the Ekip Com Actuator module, or electrical accessories, opening and closing coils and spring charging motor in the case of XT7-XT7 M. For details, ask ABB.

2) Circuit-breakers equipped with actuation module, electric accessories, opening and closing releases and spring charging motor

3) Two client web accesses included in the license

● Default available

○ Available depending on the trip unit

Electrical system

Software applications

ABB SACE offers software applications that allow the potential of the Ekip electronic trip units to be fully utilized in terms of the management of power, acquisition and analysis of the electrical values, and testing of the protection, maintenance in addition to carrying out diagnostic functions.

Overview of the software

An overview of the software available and the main characteristics are given below:

Software	Functions	Distinctive characteristics
Ekip Connect	<ul style="list-style-type: none"> - commissioning of circuit-breakers - fault analysis - communication bus testing 	<ul style="list-style-type: none"> - simple and intuitive use - integrated with DOC electrical design software - useable via EtherNet™ - automatic updating from the Internet - off-line mode - multi-media (smart phone, tablet or PC)
Ekip View	<ul style="list-style-type: none"> - supervision and control of communication networks - analysis of electrical value trends - condition monitoring 	<ul style="list-style-type: none"> - engineering free - analysis of past trends - customizable reports - access via Internet to the installation - possibility of integrating third party devices
ABB Ability™ Electrical Distribution Control System	<ul style="list-style-type: none"> - monitoring of plants - optimization of the plant - control center 	<ul style="list-style-type: none"> - alerts notification via mail - automatic report for energy efficiency - asset management

Ekip Connect

Ekip Connect is the ABB programming and commissioning software tool that allows the user to unlock the full potential of circuit-breakers, improving the efficiency of the electrical plant. A circuit-breaker is an essential part of any electrical system guaranteeing that day-to-day processes can be performed safely and continuously. For this reason, it is vital that the installation and use of the circuit-breaker is made as error-free and simple as possible.

From commissioning to implementation, through monitoring, testing and analysis, Ekip Connect is the perfect tool for guiding the user in the management of ABB circuit-breakers throughout the entire product life cycle.

Ekip Connect is the ABB commissioning and programming software that allows the potential of Ekip electronic trip units to be fully realized. Using Ekip Connect, the user can manage power, acquire and analyze electrical values and test protection, maintenance and diagnostic functions. Just as SACE EMAX 2 did before, SACE Tmax XT has evolved into a true power manager that has simplified the electrical plant, and the Ekip Connect software has become the user's key to accessing the full capabilities of the breakers.

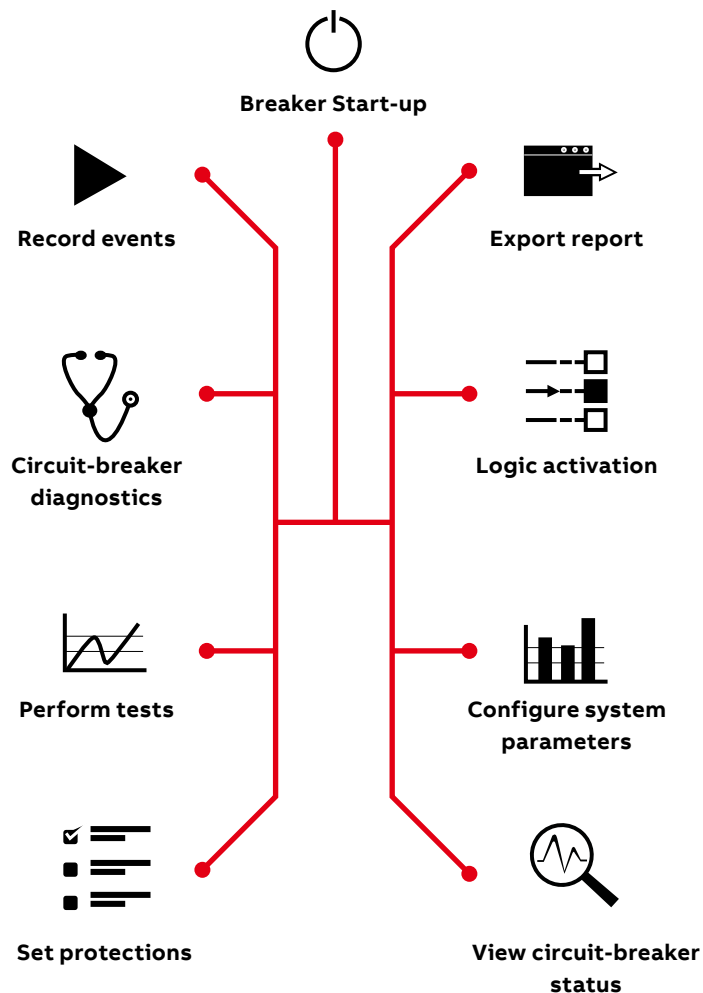

Electrical system

Ekip Connect

—
Panel builders
- 50% commissioning time



Ease of use

Imagine you are a panel builder and you have to commission a circuit-breaker and you need to save time. Using Ekip Connect it is possible to cut commissioning time up to 50%. Providing a stress-free interaction with the device complexity, Ekip Connect easy-to-use software has all the answers.

Ekip Connect's simple and intuitive interface means that, from the very start, it is possible to easily navigate the tool and access every circuit-breaker operation. At a glance, the user can see all the required information, providing the ability to quickly and effectively assess any situation.

—
Facility managers
100% full exploitation
of the device

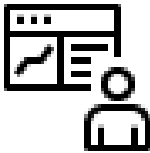

Full exploitation

Imagine you are a facility manager and you need to perform fast and precise diagnosis in order to keep everything under control and avoid failures. Using Ekip Connect you can exploit the full capabilities of your device and thanks to the customizable dashboard you can organize the functions displayed, just the way you want it. It is possible to manage all the circuit-breaker settings and specifications directly with Ekip Connect, making it the perfect instrument for exploring and using the breaker.

Diagnostics are easy too: it is possible to consult and download the log of events, alarms and unit trips, thereby facilitating the identification and understanding of any anomalies.

This software is able to manage all ABB low-voltage circuit-breakers equipped with an electronic trip unit, providing full integration of air and molded case circuit-breakers.

—
Consultants/system
integrators
Complex logics at your
fingertips



Product enhancement

Imagine you are a consultant or a system integrator and you want to implement advanced features while avoiding the risk of errors. Using Ekip Connect it is possible to implement complex logic with a few clicks of your mouse.

Adding, setting and managing advanced functions has never been so easy. Automatic transfer switch logic, load shedding, advanced protection and demand management can be managed and easily set via the Ekip Connect software. Expand the software features by purchasing and downloading software packages for advanced functions directly using Ekip Connect.

Accessing the full potential of the circuit-breaker is finally possible. Thanks to Ekip Connect software, you can achieve complete utilization of the breaker and more with just a few clicks of your mouse.



Configuration

- Set protections
- Configure system and communication parameters
- Breaker start-up



Monitoring & analysis

- View circuit-breaker status and measurements
- Read events list
- Circuit-breaker diagnostic



Product implementation

- Set advanced protections
- Logic activation
- Enable advanced functions

Test



Testing & reporting

- Check correct functionality
- Perform tests
- Export report

Ekip Connect is available for free download at <http://www.abb.com/abblibrary/DownloadCenter/>

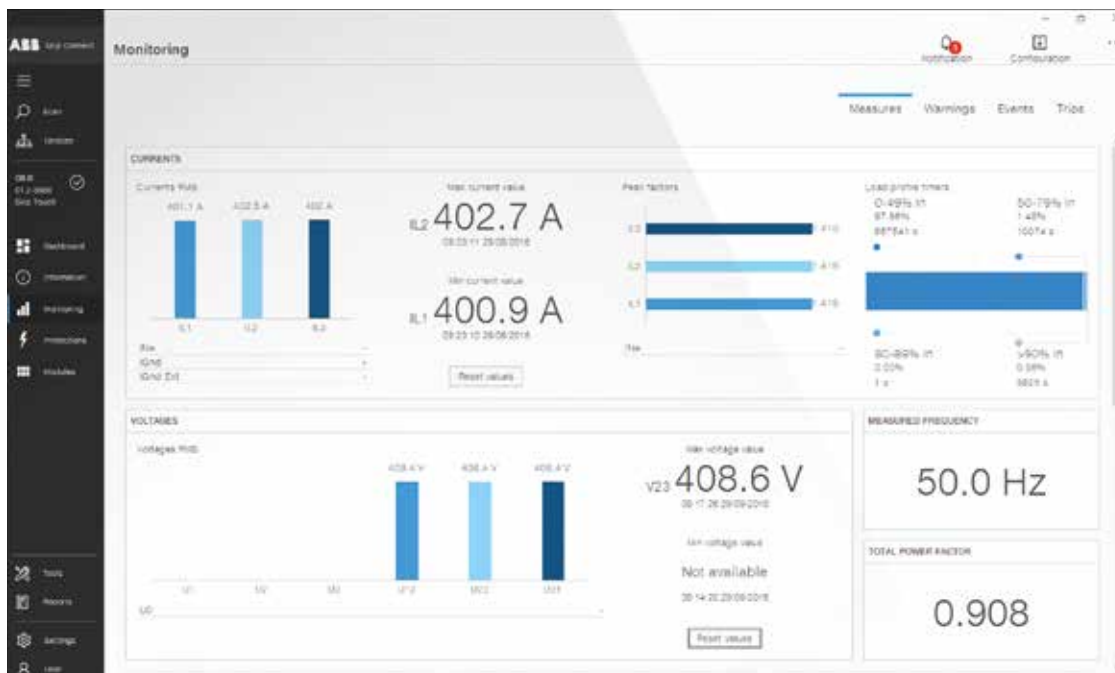

EPiC

With Bluetooth embedded into the trip units it possible to connect rapidly to the EPiC app. Buy additional protection functions or measures, register the product and configure your device. EPiC helps the customer during the commissioning of the system; all system parameters and protection thresholds can be set rapidly in the Ekip Touch trip units thanks to the easy and intuitive navigation pages of the app.

Electrical system

Ekip View

Ekip View is the software for supervising all the devices connected to a communication network that uses the Modbus RTU or Modbus TCP protocol.

Ekip View is the ideal tool for all the applications that require:

- remote control of the system,
- monitoring of power consumption,
- fault detection of the system,
- allocation of energy consumption to the different processes and departments,
- preventative maintenance planning.

The main characteristics of Ekip View are:

- **Free and ready to use** engineering software to guide the user in the recognition and configuration of the protection units without the need for any system engineering supervision.

- **Dynamic mimic panel:** after automatic scanning of the network, for each of the devices found, Ekip View proposes a dynamic symbol that summarizes the most important information (status, electrical measurements, alarms). The extensive library of electrical symbols enables the entire electrical system to be represented in detail.
- **Analysis of trends:** the instantaneous and past trends of currents, powers and power factors are represented graphically and can be exported into Microsoft Excel for detailed analysis.
- **Reports:** advanced reports can be created regarding system and communication network diagnostics. Using the Alarm Dispatcher option, the user can receive the most important notifications via text message.
- **Web access:** to the installation, thanks to Ekip View's Web Server function.

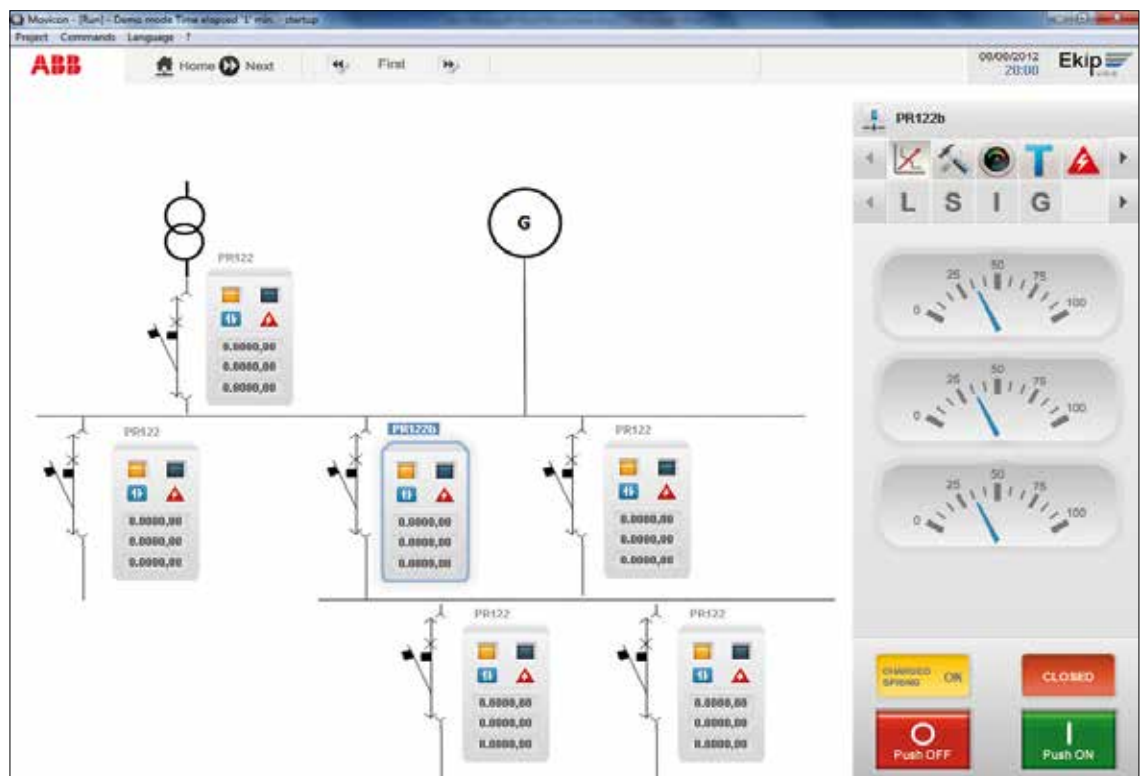

Ekip View Software		
Communication characteristics		
Protocol Supported	Modbus RTU	Modbus TCP
Physical layer	RS 485	EtherNet™
Maximum data exchange rate	19200 bps	100 Mbps
Operating system	Windows XP, Windows 7, Windows Vista	
Devices supported		
Tmax XT and Emax 2 trip units	Ekip com Modbus RS485	Ekip com Modbus TCP
Third party devices	optional ¹⁾	optional ¹⁾
Licenses available	- up to 30 ²⁾ controllable devices	- up to 30 ²⁾ controllable devices
	- up to 60 ²⁾ controllable devices	- up to 60 ²⁾ controllable devices
	- unlimited number ³⁾ controllable devices	- unlimited number ³⁾ controllable devices
Supervision and control functions		
Opening and closing of circuit-breakers ⁴⁾	●	●
Electrical value trends	●	●
Log of electrical value trends	●	●
Dynamic installation mimic panel	●	●
Automatic scanning	●	●
Centralized time synchronization	●	●
Web server function ⁶⁾	● ⁵⁾	● ⁵⁾
Measurement functions		
Currents	●	●
Voltages	●	●
Powers	●	●
Energies	●	●
Harmonics	●	●
Network analyzer	●	●
Data logger	●	●
Adjustment functions		
Setting thresholds	●	●
Resetting of alarms	●	●
Diagnostics		
Protection function alarms	●	●
Device alarms	●	●
Communication system alarms	●	●
Protection unit tripping details	●	●
Events log	●	●
Protection unit tripping log	●	●
Generation of reports	●	●
Maintenance		
Number of operations	●	●
Number of trips	●	●
Contact wear	●	●
Other data		
Status of circuit-breaker	●	●
Local/remote mode	●	●

1) Contact ABB to integrate other devices in the Ekip View software

2) Can be increased

3) Within the physical limit of the protocol used

4) Circuit-breakers are equipped with MOE-E for the XT2-XT4-XT5 or Ekip Com Actuator module, electrical accessories, opening and closing coils and spring charging motor in the case of XT7-XT7 M

5) Two client web accesses included in the license

6) According to the values supported by the trip units

Software and web application

The ABB Ability™ Electrical Distribution Control System is the innovative cloud-computing platform designed to monitor, optimize and control the electrical system.

Part of the ABB Ability™ offering, ABB Ability™ Electrical Distribution Control System, is built on a state-of-the-art cloud architecture for data collection, processing and storage. This cloud architecture has been developed together with Microsoft to enhance performance and guarantee the highest reliability and security. Through a compelling web app interface, ABB Ability™ Electrical Distribution Control System assists the user anytime and anywhere via smartphone, tablet or personal computer making the following operations possible:

- **Monitoring**
Discover plant performance, supervise the electrical system and allocate costs.
- **Optimization**
Schedule and analyze automatic reports, improve the use of assets and make the right business decisions.

- **Control**

Set up alerts, notify key personnel, and remotely implement an effective power management strategy to achieve energy savings in a simple way.

ABB Ability™ Electrical Distribution Control System also provides access to multi-site level monitoring and compares the performances of different facilities simultaneously. In addition, it allows profiling of the users' experience according to the level of access they require. According to the customer needs and application, users can choose between two configurations to connect their system to the ABB Ability™ Electrical Distribution Control System: embedded or external. The first configuration is the innovative Ekip Com Hub (a cartridge-type module) which needs to be installed on the Tmax XT circuit-breaker. The second, the Ekip E-Hub module, must be mounted on the DIN-rail.

Solution with Ekip Com Hub

A SACE Tmax XT device equipped with the new Ekip Com Hub establishes the cloud connection for the whole switchboard.

This dedicated cartridge type communication module just needs to be inserted into the terminal box and connected to the Internet. For the XT2, XT4 and XT5 sizes, it is available also as an internal module in case of limited space.





An external solution with Ekip E-Hub

The Ekip E-Hub module can be mounted on a DIN-rail to collect data throughout the system. Moreover, it is possible to connect sensors for environmental parameters (temperature, water, gas) via both analog and digital I/O. Modules for Wi-Fi or GPRS connection are provided as optional features.

For any further information please visit our website : <http://new.abb.com/low-voltage/launches/abb-ability-edcs>.



Accessories for Ekip Touch trip units

Connectivity

Tmax XT circuit-breakers can be integrated perfectly into all automation and energy management systems to improve productivity and energy consumption and to carry out remote service.

They can be equipped with communication units available for use with Modbus, Profibus, and DeviceNet™ protocols as well as with the modern Modbus TCP, Profinet and EtherNet/IP™ protocols. Furthermore, the integrated IEC 61850 communication module enables connection to automation systems widely used in medium voltage power distribution to create intelligent networks (Smart Grids). The modules are available in both solutions, internally and externally mounted. The internal modules are installed directly inside the circuit-breaker and the external modules can be easily installed directly on the terminal box or in the Ekip cartridge, even at a later date.

Accurate measurements of current, voltage, power and energy are all available by means of the communication modules.

The trip units themselves can be used as multimeters that display the measurements available, or the Ekip Multimeter can be connected on the front of the switchgear without the need for external instruments. All the functions are also accessible via the Internet, in complete safety, through the Ekip Link switchgear supervision system and the Ekip Control Panel.

In addition, a full set of information on the plant and circuit-breaker can be made available throughout the cloud via ABB Ability™ Electrical Distribution Control System.

Internal modules

Available with several different communication protocols, the Ekip Com internal module is installed directly inside the circuit-breaker. It allows the circuit-breaker to be integrated in a communication network for supervision and control. Ekip Com internal modules can be used for the XT2-XT4 and XT5. They can be connected to the trip unit when Ekip Touch is used. In other cases (for the Ekip Dip, thermal-magnetic trip unit, or switch-disconnector), the Modbus RTU and TCP, available in the STA version (Stand-Alone), can be still installed inside the circuit-breaker to provide information on the status of the circuit-breaker and remote control (adding the motor operator).



XT5 Ekip Com TCP internal module

Protocols	Ekip Touch	Ekip Dip, Thermal-magnetic unit, Switch Disconnector
Modbus RTU	■	■
Modbus TCP/IP	■	■
Profinet	■	-
EthernNet / IP	■	-
IEC61850	■	-



Communication module

External modules

These Ekip Com modules, as well as the internal modules, allow integration in any communication network. They can be used on the XT2, XT4 and XT5 with an Ekip Touch trip unit by using the Ekip Cartridge. On the XT7 and XT7 M with an Ekip Touch trip unit, they can be mounted directly on the terminal box. Several modules can be used simultaneously enabling systems with different protocols, but also, in case of high reliability requirements, Ekip Com R modules can be installed to guarantee system redundancy. The Modbus RTU, Profibus-DP and DeviceNet™ modules contain a terminating resistor and two dip switches for optional activation to terminate the serial network or bus. The Profibus-DP module also contains a polarization resistor and two dip switches for its activation. When used on the XT7 and XT7 M, communication can be maintained with withdrawable circuit-breakers, even while they remain in the racked-out position, by using Ekip AUP auxiliary position contacts and Ekip RTC ready to close circuit-breaker contacts.

Protocols	Ekip Touch
Modbus RTU	■
Modbus TCP	■
Profibus-DP	■
Profinet	■
Ethernet / IP	■
DeviceNet	■
IEC 61850	■

Ekip Cartridge



The external device connected directly to the Ekip Touch trip unit of XT2, XT4 and XT5 allows most of the connectivity modules to be used including: the Ekip Supply, Ekip Com, Ekip Link, Ekip Signaling 2K and Ekip Synchro check. It is always necessary to install the Ekip Supply module. The Ekip Cartridge is available in two different versions: with 2 slots (1 Ekip Supply + 1 module) or with 4 slots (1 Ekip Supply + 3 modules).



If needed, when circuit-breakers in the withdrawable version are used, it is possible to connect the position AUP contacts to the related pins of the cartridge to avoid failure messages on the communication channel. The cartridge can be installed on a DIN-rail everywhere in the panel. The cable that connects the trip unit with the Ekip Cartridge is 1m long.

Ekip Cartridge

Ekip Power Supply



Ekip Power Supply

The Ekip Supply module supplies all Ekip trip units and modules present on the Ekip Cartridge or terminal box of the circuit-breaker with several auxiliary power sources (in AC or DC) available in the switchgear. The module permits the installation of the other advanced modules. It can be field installed at any time. Two versions are available according to the control voltage:

- Ekip Supply 110-240V AC/DC
- Ekip Supply 24-48V DC

Accessories for Ekip Touch trip units



Ekip Link

Ekip Link

The Ekip Link module enables the Tmax XT circuit-breaker to be connected to an ABB communication system for locally supervising switchgear by means of the Ekip Control Panel and to act as a power controller. It is available in both inside-breaker and external cartridge versions. It is available as:

- an inside-breaker version for XT2, XT4, and XT5 sizes
- a cartridge and terminal box mounted version for XT2, XT4, XT5, XT7 and XT7 M sizes.

In this way, it is possible to have both local supervision of the control panel through the Ekip Control Panel, and supervision of the system through the Ekip Com modules connected to the communication network. The Ekip Link modules are supplied including the Ekip AUP auxiliary position contacts and the Ekip RTC ready to close circuit-breaker contacts.



Ekip Com Hub

Ekip Com Hub

The Ekip Com Hub is the new communication module for cloud-connectivity. A circuit-breaker equipped with Ekip Com Hub can establish a connection with an ABB Ability™ Electrical Distribution Control System for the low-voltage power distribution panel.

This dedicated module is available in two versions: the inside-breaker (for XT2, XT4 and XT5 sizes) and the cartridge/ terminal box mounted versions (for XT2, XT4, XT5, XT7 and XT7 M sizes), even when other modules are present.

For further information related to the ABB Ability™ Electrical Distribution Control System, please visit the dedicated website at <http://new.abb.com/low-voltage/launches/ekip-smartvision>.



Ekip Com Actuator

Ekip Com Actuator

The Ekip Com Actuator module enables the XT7 M circuit-breakers to be opened and closed remotely. The Ekip com Actuator is optional and can be ordered for all Ekip Touch trip units equipped with Ekip Com or Ekip Link modules. The Ekip Com Actuator is installed on the front of the circuit-breaker in the right-hand accessories area.

Signaling

Ekip 1K Signalling

The Ekip 1K Signalling module, available for the XT5, supplies one input contact and one output contact for control and remote signaling. It can be programmed from the trip unit display or through the Ekip Connect software and app. Furthermore, when using Ekip Connect, combinations of events can be freely configured. The Ekip 1K Signalling device is installed inside the circuit-breaker in the housing provided on the left down side of the circuit-breaker and it can be used when an Ekip Touch trip unit is present.



Ekip Signalling 1K



— Ekip 2K Signalling modules

Ekip 2K Signalling modules

The Ekip 2K Signalling modules supply two input and two output contacts for control and remote signaling of alarms and circuit-breaker trips. They can be programmed from the trip unit display or via the Ekip Connect software and app. Furthermore, when using Ekip Connect, combinations of events can be freely configured. Three versions of the Ekip 2K Signalling modules are available: Ekip 2K 1, Ekip 2K-2, and Ekip 2K-3.

In this way, a maximum of three modules for XT2, XT4, XT5, XT7 and XT7 M can be installed at the same time into an Ekip Cartridge (for XT2, XT4 and XT5 sizes) or into the terminal box (for XT7 and XT7 M sizes).



— Ekip 10K Signalling unit

Ekip 10K Signalling unit

The Ekip 10K Signalling unit is an external device designed for DIN-rail installation. The unit provides ten contacts for electrical signaling of timing and tripping of protection devices. If connected via the Ekip Connect software, the contacts can be freely configured in association with any event and alarm or combination of both. Several Ekip 10K Signalling units (max 4) can be used at the same time on the same Ekip trip unit. The Ekip 10K Signalling module can be powered either by direct or alternating current and can be connected to all the trip units via internal bus or Ekip Link modules.

Output contacts characteristics		Number of contacts	
Type	Monostable	Ekip 1K	Ekip 2K
Maximum switching voltage	150V DC / 250V AC		
Maximum switching current			
30V DC	2A	1 output + 1 input	2 output + 2 input
50V DC	0.8A		
150V DC	0.2A		
250V AC	4A		
Contact/coil insulation	1000 Vrms (1min @50Hz)		

Ekip 10K Signalling unit power supply	
Auxiliary supply	24-48V DC, 110-240V AC/DC
Voltage range	21.5-53V DC, 105-265V AC/DC
Rated power	10VA/W
Inrush current	1A for 10ms

Signaling contacts for the XT7 and XT7 M Ekip trip units

With XT7 and XT7 M circuit-breakers, the Ekip trip units can acquire the status of the circuit-breaker ready to close (RTC) and racked-in, test, or racked-out position through the optional Ekip RTC and Ekip AUP signaling contacts. These contacts, housed in the accessories area of the circuit-breakers, are available with the Ekip Dip and Ekip Touch.



— Signaling contacts for Ekip trip units

Accessories for Ekip Touch trip units

Protection

Ekip Synchrocheck

This module enables the control of the synchronism condition when placing two lines in parallel. The module can be used with the Ekip Touch trip units. Ekip Synchrocheck measures the voltages from two phases of one line through an external transformer and compares them to the voltage values measured at the circuit-breaker. An output contact is available, which is activated upon synchronism, and enables the circuit-breaker to be closed by means of wiring with the closing coil.

The Ekip Synchrocheck can be installed in the Ekip Cartridge (for XT2, XT4 and XT5) and in the terminal box (for XT7 and XT7 M).



Ekip Synchrocheck

Output contacts characteristics		Number of contacts
Type	Monostable	Ekip Synchrocheck
Maximum switching voltage	150V DC / 250V AC	
Maximum switching current		
30V DC	2A	1 output
50V DC	0.8A	
150V DC	0.2A	
250V AC	4A	
Contact/coil insulation	1000 Vrms (1min @50Hz)	

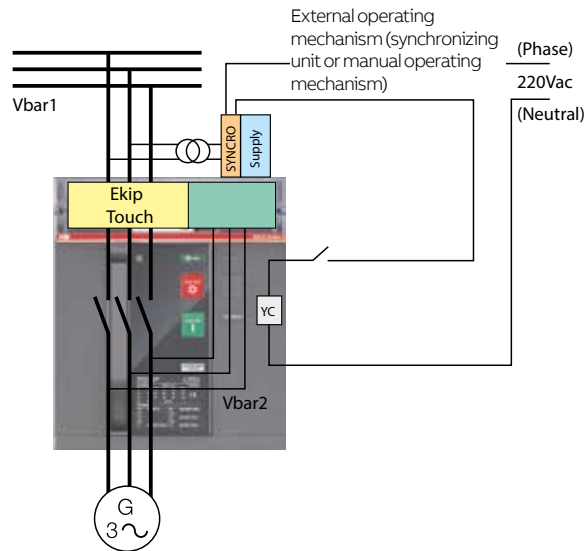



Ekip CI

Ekip CI

This module is an accessory for the Ekip M Touch LRIU trip unit and is needed when the circuit-breaker and the contactor must work in conjunction with each other. In this way the higher number of operations of the contactor are used instead of the circuit-breaker. When the trip unit is set in Normal mode (default mode) by means of the Ekip CI module the contactor is activated in one of the protection trips (excluding I and G protections); if the Heavy mode is set the trip unit directly opens the circuit-breaker. The auto-reset function allows the actuation status of the Ekip CI to reset automatically after the contactor has tripped owing to the L function, once an adjustable time from 1 to 1000s has elapsed. Auto-reset can occur only in Normal mode. The BACK UP function is available and deals with situations whereby an opening command transmitted to the contactor via module Ekip CI has not been successful. In this case, the Ekip M Touch LRIU trip unit sends an opening command to the circuit-breaker after waiting a set time Tx. The actuation time of the contactor given by the manufacturer must be considered when the Tx time delay setting is entered. The function is active with an auxiliary supply.



Rating Plug

Rating Plug

The rating plugs are field interchangeable from the front on all the trip units and the protection thresholds can be adjusted according to the actual rated current of the system. This function is particularly advantageous in installations that may require future expansion or when the power supplied needs to be limited temporarily (e.g. mobile Gen Set). For the XT7 and XT7 M special rating plugs are also available for residual current protection against ground faults combined with a suitable external toroid. For the XT5, the following rating plugs are available for the two versions of Ekip Touch (400A and 630A). On the Ekip Touch 400 it is not possible to install the 500A and 630A rating plugs.

Nominal Value of the Rating Plug	Ekip Touch 400A	Ekip Touch 630A
250A	■	■
320A	■	■
400A	■	■
500A	-	■
630A	-	■

■ compatible
 - not compatible

For XT7 and XT7 M the following rating plugs are available

Ekip Dip LS/I, Ekip Dip LIG, Ekip M Dip I, Ekip G Dip LS/I	
Nominal Value	Standard Rating Plug
630A	■
800A	■
1000A	■
1250A	■
1600A	■

■ compatible

Ekip Dip LSI, Ekip Dip LSIG, Ekip Touch all		
Nominal Value	Standard Rating Plug	Rating Plug for RC protection
800A	■	■
1000A	■	-
1250A	■	■
1600A	■	-

■ compatible
 - not available

Accessories for Ekip Touch trip units

Cables and connectors

XT2-XT4 default supply with Ekip Touch trip units

The following items are always provided with the Ekip Touch trip units:

- A 24V DC supply / internal bus cable: that supplies the trip unit and connects the Ekip Cartridge and the Ekip Multimeter
- A side connector to connect the trip unit to the 24V DC/internal bus cable, selectivity cable, and the external neutral cable.

XT5 default supply with Ekip Touch trip units

The following items are always provided with the Ekip Touch trip units:

- A 24V DC supply / internal bus cable: that supplies the trip unit, connect the Ekip Cartridge and the Ekip Multimeter.

When a circuit-breaker with the withdrawable version of the trip unit is required, the following accessories can be used:

- XT2-XT4 connection kit 24V/internal bus/external neutral/zone selectivity
- XT5 connection kit 24V/internal bus (mandatory with the withdrawable version)

Zone Selectivity

To use the zone selectivity function for G and S protections, it's needed to order the zone selectivity cable.

External neutral sensors



Current sensor for neutral conductor outside the circuit-breaker

Ekip Dip

The external neutral current sensor (to protect the neutral conductor) is available for 3-pole circuit-breakers equipped with Ekip Dip LIG, Ekip Dip LSI, and Ekip Dip LSIG electronic trip units.

Ekip Touch

With this trip unit it is possible to use both current and voltage sensors (to measure or protect the neutral conductor). The current sensor is available only for 3-pole circuit-breakers.

For the XT7 and XT7 M the current sensor is connected through the terminal box; moreover the voltage connection can also be added to the terminal box area by just connecting a cable to the right connection point. For the XT2, XT4 and XT5 it possible to select one of the following solutions:

- a kit for external neutral voltage connections, to only measure the voltage
- a current sensor (CS) for external neutral, to only measure the current
- current sensor + voltage (CS+V) for external neutral, to measure both current and voltage.

The sensors are available with the following nominal currents:

Circuit Breaker	In	Ekip Dip				Ekip Touch
		LIG	LSI	LSIG	G-LS/I	
XT2	10	■	■	■	■	-
	25	■	■	■	■	-
	40	-	-	-	-	■
	63	■	■	■	■	■
	100	■	■	■	■	■
	160	■	■	■	■	■
XT4	40	■	■	■	■	-
	63	■	■	■	■	-
	100	■	■	■	■	■
	160	■	■	■	■	■
	250	■	■	■	■	■
XT5	250	■	■	■	■	■
	320	■	■	■	■	■
	400	■	■	■	■	■
	630	■	■	■	■	■
XT6	630	■	■	■	■	
	800	■	■	■	■	
	1000	■	■	■	■	
XT7	630	■	■	■	■	■
	800	■	■	■	■	■
	1000	■	■	■	■	■
	1250	■	■	■	■	■
	1600	■	■	■	■	■



Homopolar toroid for the earthing conductor of the main power supply

Homopolar toroid for the earthing conductor of the main power supply

The Ekip Touch trip units can be used with an external toroid positioned, for example, on the conductor that connects the star center of the MV/LV transformer to earth (homopolar transformer): in this case, the earth protection is called Source Ground Return. Four sizes of the toroid are available: 100A, 250A, 400A, 800A. The homopolar toroid is an alternative to the toroid for differential protection.

This is for the XT7 and XT7 M only.

Toroid for differential protection

Connected to the Ekip Touch trip units equipped with a rating plug for differential protection, this toroid enables earth fault currents of 3...30A to be monitored. This is an alternative to the homopolar toroid and should be installed on the busbar system. This is for the XT7 and XT7 M only.



Toroid for differential protection

Accessories for Ekip Touch trip units

Display and supervision

Ekip Multimeter Display for the front of the switchgear

The Ekip Multimeter is a display unit which can be installed on the front of the switchgear for the Tmax XT circuit-breakers equipped with Ekip Touch trip units. The device is equipped with a large touch screen display and enables measurements to be displayed. If connected to trip units with a display, the Ekip Multimeter enables the adjustment of parameters and protection thresholds. Up to 4 Ekip Multimeter devices can be connected at the same time to the same Ekip protection trip unit to display currents, voltage, power and energy. The Ekip Multimeter can be connected to a single trip unit and can be powered either by direct current (24-48V DC or 110-240V DC) or alternating current (110-240V AC). It is equipped with a 24V DC output that supplies the trip unit to which it is connected.



An Ekip Multimeter Display for the front of the switchgear.

Power supply	24-48V DC, 110-240V AC/DC
Tolerance	21.5-53V DC, 105-265V AC/DC
Rated Power	10VA/W
Inrush current	2A for 20ms

Ekip Control Panel for the front of the switchgear

The Ekip Control Panel enables the circuit-breakers connected to the Ekip Link system to be controlled and monitored. The panel is supplied already equipped with supervision software and requires no programming. The Ekip Control Panel requires a 24V DC power supply and is equipped with:

- 2 RJ45 Ethernet ports for connection to the Ekip Link system and to the local network for remote control via web server option
- 1 RS485 serial port for integration with the Modbus network if it is to be used with circuit-breakers from the Tmax series
- 4 USB ports for downloading data.



An Ekip Control Panel for the front of the switchgear.

Accessories for electronic trip units

Testing and programming

Ekip TT testing and power supply unit

This unit is compatible with the Ekip Dip and Ekip Touch trip units and allows a trip unit to be supplied so that the last protection device tripped can be viewed directly on the display or identified as the corresponding LEDs light up. The Ekip TT is a device that verifies that the circuit-breaker trip mechanism is functioning correctly (trip test). This device can be connected to the front test connector of any Ekip trip unit.



Ekip TT testing and power supply unit

Ekip T&P testing kit

The Ekip T&P is a kit that includes different components for programming and testing the electronic protection trip units.

The kit includes:

- The Ekip T&P unit;
- The Ekip TT unit;
- Adaptors for the Emax and Tmax trip units;
- A USB cable to connect the T&P unit to the Ekip trip units;
- An installation CD for the Ekip Connect and Ekip T&P interface software.

The Ekip T&P unit is easily connected from your PC (via USB) to the trip unit (via mini USB) with the cable provided. The Ekip T&P unit can perform simple manual or automatic tests of the trip unit functions. Additionally, the Ekip T&P provides the possibility to perform more advanced function testing that allows simulations of very critical applications: real conditions of a system can be accurately represented by considering additional harmonics and shifting of phases. It also generates a test report as well as monitor maintenance schedules.

Ekip Programming module

The Ekip Programming module is used for programming Ekip trip units via PC using the Ekip Connect software that can be downloaded online. The Ekip Programming module, which is connected to the PC via USB, can be useful for uploading/downloading entire sets of parameters for more circuit-breakers both for set-up and maintenance.



Ekip Programming module

Accessories for XT2-XT4 Ekip trip units

Compatible with Ekip LSI and Ekip LSIG trip units for the XT2 and XT4 sizes



Ekip Display

Ekip Display

The Ekip Display is a unit that can be applied on the front of the solid-state trip unit and shows the current values, alarms, and protection settings.

Main features:

- **Installation:** The Ekip Display can be easily installed on the front of the Ekip LSI and Ekip LSIG electronic trip units. It is connected by means of the test connector on the front of the trip unit, and fixing is simple and reliable thanks to a specially designed mechanism. This mechanism also provides a practical way of fastening the accessories to the circuit-breaker to prevent undesired access to the dip-switches. Installation can be carried out under any condition, even with the door closed and the electronic trip unit already on and functioning.
- **Functions:** The Ekip Display has four buttons for browsing through the menus. It functions in self-supply mode starting from a current of $I > 0.2 \times I_n$ circulating through at least one phase. Backlighting is activated in the presence of higher loads, thereby allowing better legibility of the visualized information. Rear lighting comes on in self-supply for a current of $I > 0.4 \times I_n$ and is always on when there is an electronic trip unit auxiliary power supply.

The Ekip Display:

- shows the current, voltage, power and energy values;
- shows the settings of the protection functions in Amperes or in I_n ;
- shows the protection that has caused the trip unit to trip and the fault current (only when there is 24V external voltage or the Ekip TT unit);
- allows the trip thresholds of the trip unit to be programmed and the communication parameters to be set on the bus system.
- **Compatibility:** The Ekip Display can be fitted even when the front accessories, such as the motor or direct and transmitted rotary handles etc. are already installed. It is possible to use Ekip TT or Ekip T&P without removing the Ekip Display.



Ekip LED Meter

Ekip LED Meter

The Ekip LED Meter can be applied to the front of the electronic trip unit and displays the current values and alarms.

Main features:

- **Installation:** The Ekip LED Meter can be easily installed on the front of Ekip LSI and Ekip LSIG electronic trip units. It is connected by means of the test connector on the front of the trip unit and fixing is simple and reliable thanks to a specially designed mechanism. This mechanism also provides a practical way of fastening the accessories to the circuit-breaker to prevent undesired access to the dip-switches. The installation can be carried out under any condition, even with the door closed and the electronic trip unit already on and functioning;
- **Functions:** The Ekip LED Meter provides an accurate indication of the value of the current circulating in the trip unit by means of a scale of LED. Their different colors allow normal operation, pre-alarm and alarm states of the circuit-breaker to be recognized at a glance. It is active in self-supply mode from a current of $I > 0.2 \times I_n$ circulating through at least one phase or when the auxiliary power is available for the electronic trip unit;
- **Compatibility:** The Ekip LED Meter can also be fitted when front accessories, such as the motor, direct and transmitted rotary handles etc. are already installed. It is possible to use the Ekip TT or Ekip T&P without removing the Ekip LED Meter. It is not possible to use the Ekip LED Meter with a withdrawable breaker version.

Accessories for XT2-XT4 Ekip trip units



Ekip Com

Ekip Com

The Ekip Com allows the MOE-E motor operator to be controlled, to determine the ON/OFF/TRIP state of the circuit-breaker and to connect an electronic trip unit to a Modbus communication line. The Ekip Com is available in two versions: one version for the circuit-breakers in the fixed/plug-in version and a version complete with a connector for the fixed moving parts for circuit-breakers in the withdrawable version.

Main characteristics:

- **Installation:** The Ekip Com module is inserted in the right-hand slot of the circuit-breaker and fixing is carried out without any need for screws or tools. Connection to the trip unit is done by using a special small cable which is fitted with a cable guide. The connection towards the Modbus line is made by means of the terminal box to which a 24V DC auxiliary power supply must also be connected, which activates both the module and the protection trip unit.
- **Functions:** The Ekip Com module can acquire the state of the circuit-breaker remotely and, in combination with the MOE-E motor operator, allows the circuit-breaker to be opened and closed. If combined with a trip unit fitted with a communication function (Ekip LSI or Ekip LSI^G), the Ekip Com module allows the trip unit to be connected to a Modbus network, offering the possibility of programming the protections and acquiring the measurements and alarms when it is connected to a control and/or supervision system. When it is connected to the HMI030 unit, it is possible to have this data locally on the front of the switchboard.

Accessories for XT2-XT4 Ekip trip units



—
HMI030 interface on the front of the switchboard

HMI030 interface on the front of the switchboard

The HMI030 is an interface on the front of the switchboard which is only usable with protection trip units fitted with the Ekip Com.

Main features:

- **Installation:** The HMI030 can be fitted into the hole in the door using an automatic click-in method. In situations where mechanical stress is particularly intense, it can also be installed by using the special clips supplied. It must be connected directly to the Ekip LSI and Ekip LSI² protection trip units with Ekip Com via the serial communication line. The HMI030 requires a 24V DC power supply.
- **Functions:** The HMI030 consists of a graphic display and four buttons for browsing through the menus. This accessory allows you to view:
 - the measurements taken by the trip unit to which it is connected;
 - the alarms/events of the trip unit.
 Thanks to its high level of accuracy, the device is a valid substitute for conventional instruments without any additional current transformer.
- **Communication:** The HMI030 is provided with two communication lines, to be used alternatively with:
 - Modbus
 - Local Bus

Connecting the Ekip LSI and Ekip LSI² to the Local Bus allows the Modbus line of the Ekip Com module to connect to a different communication network.

Energy Measurements

- 5/2** **Introduction**
- 5/4** **Class 1 accuracy**
- Network Analyzer**
- 5/5** Applications
- 5/7** The first step towards better power quality: measurement
- 5/8** Operating principles

Introduction

The Tmax XT circuit-breakers have been designed to manage all low voltage electrical installations with maximum efficiency: from industrial plants, naval applications, traditional and renewable power generation installations to buildings, shopping centers, data centers and communication networks.

Achieving maximum efficiency of an electrical installation in order to reduce consumption and waste requires intelligent management of power supplies and energy. For this reason, the new technologies used in the Tmax XT circuit-breakers

with Ekip Touch trip units allow the productivity and reliability of any installation to be optimized, and at the same time, power consumption to be reduced while fully respecting the environment.



**Class 1 in power and energy measurements**

Before starting to take any action on electrical systems and to analyze the available data, top accuracy on measurements must be guaranteed. Thanks to the Ekip Touch trip units, the SACE Tmax XT range of circuit-breakers guarantees extremely accurate measures, in compliance with the relevant IEC 61557-2 Standard.

Network Analyzer

The quality of the power supply is an important factor to consider in order to preserve the loads, to avoid equipment malfunctions, and to optimize energy consumption. The power quality of a power system is never a perfect sinusoidal waveform, distortions and harmonics are always present. Several parameters that cause reductions in power quality can be monitored and controlled thanks to the Network Analyzer embedded function. In this way, the use of expensive external devices can be avoided.

Class 1 accuracy

With the Ekip Touch trip units the embedded measurement functionalities allow the measurement of power and energy to a Class 1 degree of accuracy, as specified by the IEC 61557-12 Standard, avoiding the need of additional device saving costs, space and installation time.

With the Ekip Touch trip units, measurements of power and energy to a IEC 61557-12 Standard compliant, Class 1 level of accuracy, are guaranteed by the embedded measurement functionalities. Thus, there is no need for additional devices, with consequent advantages in terms of cost savings, space reduction and installation time optimization.

When energy needs monitoring, even a minimal percentage of errors would result in a waste of money. Accuracy is everything and depends on the design and manufacturing quality of solution used. The Tmax XT with Ekip Touch trip units guarantee 1% accuracy for power and energy monitoring.



Thanks to the extremely accurate Rogowsky coil, ABB Ekip Touch trip units are able to guarantee Class 0.5 for voltage and current measurements and Class 1 for active power and energy measurements, complying with and certified by the IEC 61557-12 Standard (see Chapter 3 for more detailed information about the accuracy and the monitored parameters of the electrical system). IEC 61557-12 can be applied to both AC and DC electrical networks up to 1000 V AC or 1500V DC.

Moreover, an upgrade of the device is always guaranteed to be quick and easy: the measurement functions not included in an installed trip unit can be downloaded directly from the Market-Place via EPiC, thus allowing new system requirements to be met with ease.

Measurement data can be displayed in several ways:

- On the embedded display on the trip unit
- On a smartphone via Bluetooth (EPiC App)
- Using the Ekip Connect software on a PC
- On an Ekip Multimeter external display
- On a cloud-platform thanks to ABB Ability™ EDCS
- In the supervision system (ex SCADA) thanks to several communication protocols
- On the control panel display

Network Analyzer

Thanks to the Network Analyzer function available in all Ekip Touch trip units, the quality of energy based on harmonics, micro-interruptions or voltage dips is monitored without the need for dedicated instrumentation.

Thanks to Network Analyzer, effective preventive and corrective action can be implemented through accurate analysis of faults, thereby improving the efficiency of the system.

Applications

Electrical equipment is designed for optimum operation under constant and uniform voltage level, as close as possible to the rated value. In addition, industrial equipment, working on a three phase supply, requires the three phase voltage levels to be balanced. Power quality is a description of how well a power system complies with the above ideal conditions. Power quality issues can have negative consequences on the components and on the energy efficiency of the network. Thus, power quality monitoring is becoming more important in modern power systems, and will be a key part of the smart grid of the future.

In particular, power quality evaluation includes the following aspects:

- Deviations of voltage average value from the rated value
- Short decreases (sags) or increases (swells) of voltage value
- Voltage unbalance, i.e., difference in voltage values between different phases
- The presence of current and voltage harmonics.

Distortions of the voltage value (sags, swells) and/or frequency can have fatal consequences, especially for process industries, leading to possible production stoppages with consequently expensive downtime, damage to motor drives and damage to PLCs. Examples of process industries that can be badly hit by voltage instabilities include the plastics, petrochemicals, textiles, paper, semiconductor, and glass industries. Voltage sag is defined as when the value of the voltage is reduced below the rated one for a certain amount of time. Similarly, voltage swell is defined as when the voltage is increased above the rated value for a certain amount of time. RMS voltage values and frequency are two fundamental features of a voltage signal, but the “purity” of the voltage waveform is also an important point. An ideal voltage waveform should be a perfect sinusoid, but this is not something that is normally seen in the real world. Frequencies other than the fundamental are always present. These frequencies are called harmonics: a harmonic of a signal is a component frequency of the wave spectrum that is a multiple of the fundamental frequency. Harmonic content is an issue that is becoming increasingly debated: technological developments in the industrial and household field have led to the spread of electronic equipment which, due to their operating principles, absorb a non-sinusoidal current (non-linear load). Such current causes a non-sinusoidal voltage drop on the supply side of the network with the consequence that the linear loads are also supplied with a distorted voltage.

Network Analyzer

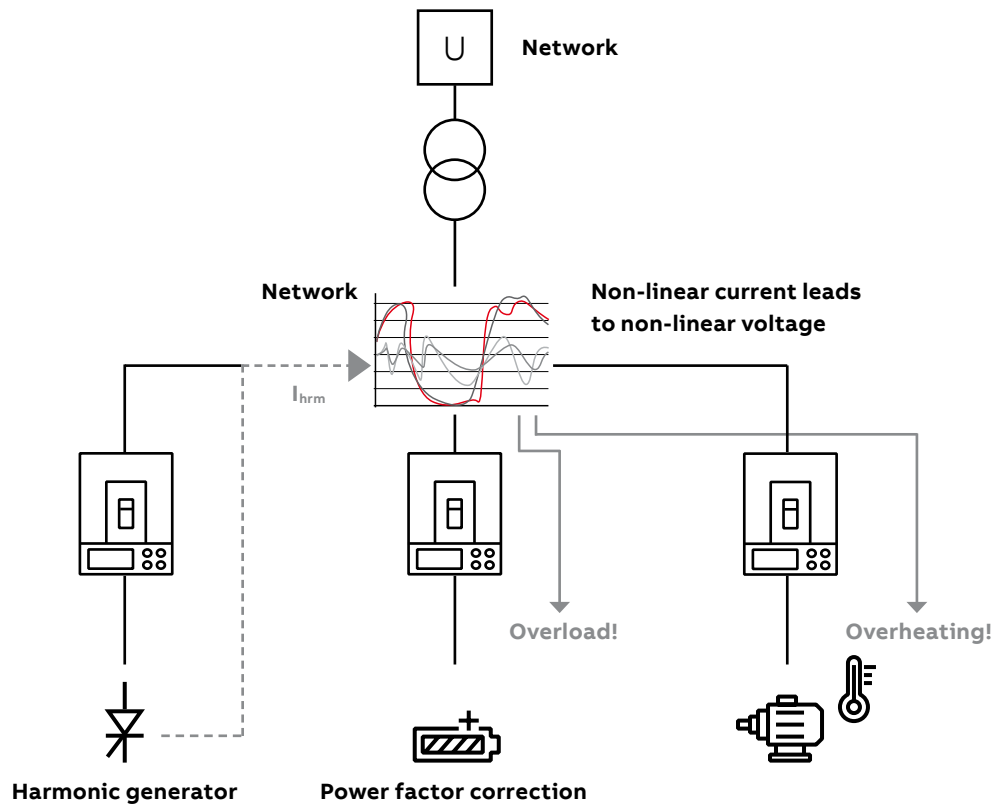

Power electronics produce harmonic content that can affect other loads in the plant: the result can be an overheating of the asynchronous motor and an overload (that could lead to a trip of the protecting MCCB) on the power factor correction capacitors.

To get information about the harmonic content of voltage and current waveforms and to take measures if such values are high, a dedicated index has been defined. The total harmonic distortion (THD) of a signal is a measurement of the harmonic distortion present.

The first step towards better Power Quality: measurement

A Power Quality monitor is the most commonly used tool for detecting voltage sags and power quality issues. Measurement is the first step for checking the status of the installation and starting the root cause analysis. Power Quality measurements and related instrumentation are described in specific industrial Standards such as IEC61000-4-30 and IEEE 1250. For the first time, thanks to the Ekip Touch trip units for the Tmax XT, the power quality monitor is embedded in a low voltage molded case circuit-breaker. The Network Analyzer function complies with the prescriptions of IEC 61000-4-30 and IEEE 1250.

The Network Analyzer function allows the user to set controls on the voltage in order to analyze the operation of the system: any time a control parameter exceeds a preset threshold, an alarm is generated. The accuracy of voltage measurements by the Tmax XT is excellent at 0.5%. The Tmax XT Network Analyzer complies with IEEE 1250-2011, Section 3 for the monitoring of the voltage value, unbalance and harmonic content, which is the equivalent of IEC61000-4-30 Class S for voltage values and unbalance and Class B for the harmonic content.

Network Analyzer

Hourly average voltage value

Short voltage interruption

Short voltage spikes

Slow voltage sags and swells

Voltage unbalance

Armonic analysis

Referring to the voltage sag ambit, as an example, the Network Analyzer function has the ability to control three kinds of sag classes, defined by the user:

Parameter	Description
Sag Threshold (First Class)	This defines the first alarm threshold. It is expressed as % Un.
Sag Times (First Class)	In the event of dropping under the first alarm threshold, this defines the time beyond which the alarm counter is increased.
Sag Threshold (Second Class)	This defines the second alarm threshold. It is expressed as % Un.
Sag Times (Second Class)	In the event of dropping under the second alarm threshold, this defines the time beyond which the alarm counter is increased.
Sag Threshold (Third Class)	This defines the third alarm threshold. It is expressed as % Un.
Sag Times (Third Class)	In the event of dropping under the third alarm threshold, this defines the time beyond which the alarm counter is increased.

Two different types of counters for each power quality monitoring function are made available directly on the trip unit touch screen: one is a cumulative counter, which stores all the alarms (for example, all the voltage sags) from the beginning, and one is a 24h counter, that shows the alarms in the last 24 hours.

With the optional communication module (Modbus, Profibus, Profinet, etc.) eight counters for each power quality monitoring function are available: one is the cumulative and the other seven are the daily counters of the last seven days of activity.

Network Analyzer

Operating Principle

The Network Analyzer function performs continuous monitoring of the quality of energy, and shows all results through a display or communication module. In particular:

- **Hourly average voltage value:** in accordance with international Standards, this must remain within 10% of the rated value, but different limits can be defined according to the needs of the installation. The positive sequence voltage is compared with the limits. If the limits are exceeded, the Ekip Hi-Touch generates a signaling event. The number of these events is stored in a suitable counter. The counter values are available for each of last 7 days, as well as the total. The measures available are the positive and negative sequence voltages and positive and negative sequence currents of the last interval monitored. The time of the calculation of the average values can be set between 5 minutes and 2 hours.
- **Interruptions / short dips in voltage:** if the voltage remains below a threshold for more than 40ms, the Ekip Hi-Touch generates an event that is counted in a dedicated log. The voltage is monitored on all lines.
- **Short voltage spikes** (voltage transients, spikes): if the voltage exceeds a threshold for 40ms, set for a pre-determined time, the Ekip Hi-Touch generates an event that is counted.
- **Slow voltage sags and swells:** when the voltage strays outside a range of acceptable limit values for a time greater than the one set, the Ekip Hi-Touch generates an event that is counted. Three values can be configured for voltage sags and two for voltage swells, each associated with a time limit: this enables verification of whether the voltage remains within a curve of values that are acceptable by equipment such as computers. The voltage is monitored on all lines.
- **Voltage unbalances:** if the voltage values are not equal or the phase displacements between them are not exactly 120°, an unbalance occurs, which is manifested with a negative sequence voltage value. If this limit exceeds the threshold value set, an event is stored which is counted.
- **Harmonic analysis:** the harmonic content of voltages and currents, measured to the 50th harmonic, as well as the value of the total harmonic distortion (THD), are available in real time on the display or through the communication modules. The Ekip Hi-Touch also generates an alarm if the THD value or a magnitude of at least one of the harmonics exceeds the values set. The voltage and current values are monitored on all phases.

All information can be displayed directly on the screen (for the XT5, XT7, XT7 M) or on a smartphone, a PC or in a network system with any of the communication modules. This is an embedded function of Ekip Touch trip units and analyzes important parameters of the distribution network including:

- The average Voltage value
- Short Voltage interruptions and spikes
- Slow Voltage sags and swells
- Voltage unbalance
- Harmonic analysis

Solutions

- 6/2 Introduction**
- 6/4 Power Controller**
- 6/7 Interface Protection System and Interface Device**
- 6/9 Adaptive protections**
- 6/11 Load Shedding**
- 6/13 ATS function**
- 6/15 Synchro Reclosing**

Introduction

The use of renewables has been growing over the last 10 years reducing the polluting emission for a greener world. Due to environmental changes, people have started to think about ecology and sustainability, increasing their awareness of energy self-consumption and increasingly concerned about energy efficiency.

The Tmax XT is the first smart moulded case circuit-breaker enabling all-in-one solutions that combine advanced protection, programmable logic, full connectivity, easy integration and comprehensive energy management in a single revolutionary device or at the local generation side. Installed downstream the MV/LV transformer, Tmax XT works like a certified interface protection system in order to check the main grid conditions and disconnect the user's plant whenever the grid voltage and frequency are out of the ranges prescribed by the connection local standard. The Tmax XT and its adaptive protections recognize the network changes and automatically set new thresholds to guarantee protection and coordination in on-grid and off-grid conditions.

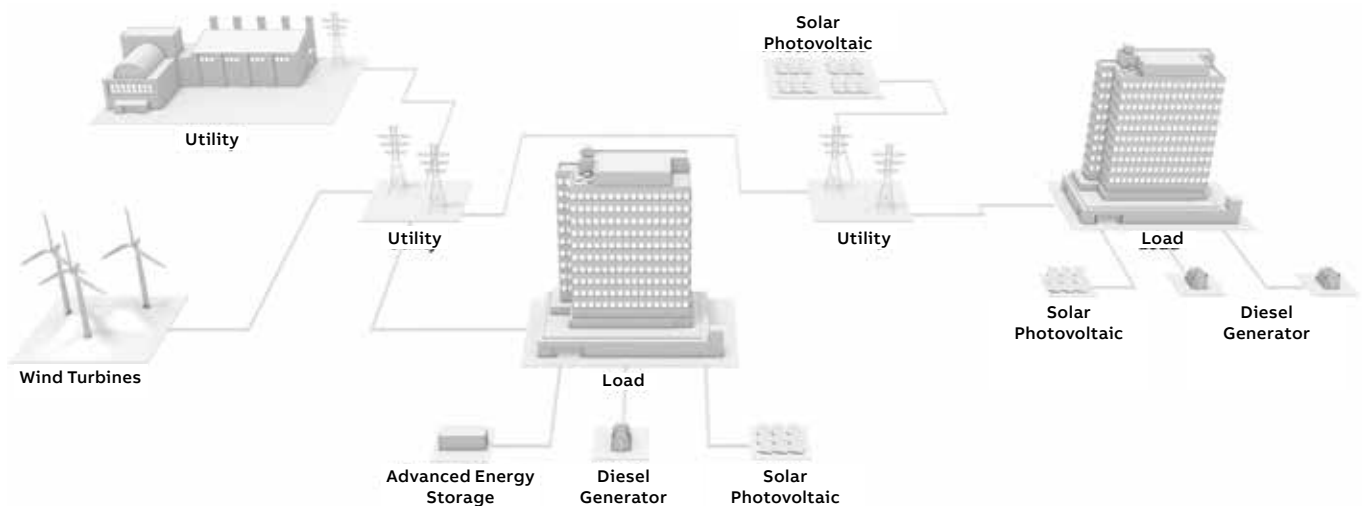

The Tmax XT is able to integrate programmable logic for protection features and Automatic Transfer Switching (ATS) in one device. This unique integrated solution avoids the usage of other external control units, guaranteeing a minimal switchgear footprint and saving commissioning time.

A strong reduction in the connection wiring simplifies the installation and commissioning phase. The load shedding embedded algorithm is able to manage the power system for comprehensive microgrid energy management.

Before the transfer from the main grid to the local line, selected loads are shed to support power balance. Using a frequency slope, the Tmax XT disconnects loads only in cases of emergency unbalanced conditions.

As the main grid is stable, thanks to the **Synchro Reclosing** logic, it is possible to synchronize the plant voltage and frequency to reconnect it. In grid-connected operations, the Tmax XT manages the **Power Controller** algorithm to shave peaks and shift loads in order to optimize system performance and productivity.

The advanced features of the Tmax XT are easily customized thanks to commissioning software tools which do not require high level engineering competencies. Ready to use templates enable the download of all the logic directly in the trip unit. The solutions are plug & play, increasing modularization and standardization for design and installation.

The advanced functionalities which have been developed and integrated in the Tmax XT are described in the following compatibility table.

	Interface Protection	Load Shedding	Automatic Transfer Switch	Synchro Reclosing	Power Controller
Interface Protection	●	●			●
Load Shedding	●		●	●	●
Automatic Transfer Switch		●	●	●	●
Synchro Reclosing		●	●	●	●
Power Controller	●	●	●	●	●

Power Controller

The Tmax XT is able to control loads and generators to ensure bill savings and enable demand response according to power management strategies.

Purpose

Thanks to the Power Controller software, Tmax XT manages the power to shave the peaks and shift the loads. In this way, it is possible to cut electricity bills, increase energy efficiency by up to 20% and be ready for demand response programs. The Power Controller function is based on a patented calculation algorithm that allows a load list to be controlled via the remote command of relevant switching devices or control circuits according to a defined priority. The user (locally), or the load aggregator / utility (remotely) - define the load disconnection priority based on their own requirements and types of loads.

The algorithm is designed for the anticipated average power absorption which can be set by the user over a determined time interval. Whenever this value exceeds the fixed power, the Power Controller function intervenes to bring it back within the limits. This system can be realized with a single Tmax XT Control or Tmax XT Control+ Standard equipped with this function and installed as the low voltage plant controller. Furthermore, the control unit, not only manages passive loads, but it can also manage a reserve generator.

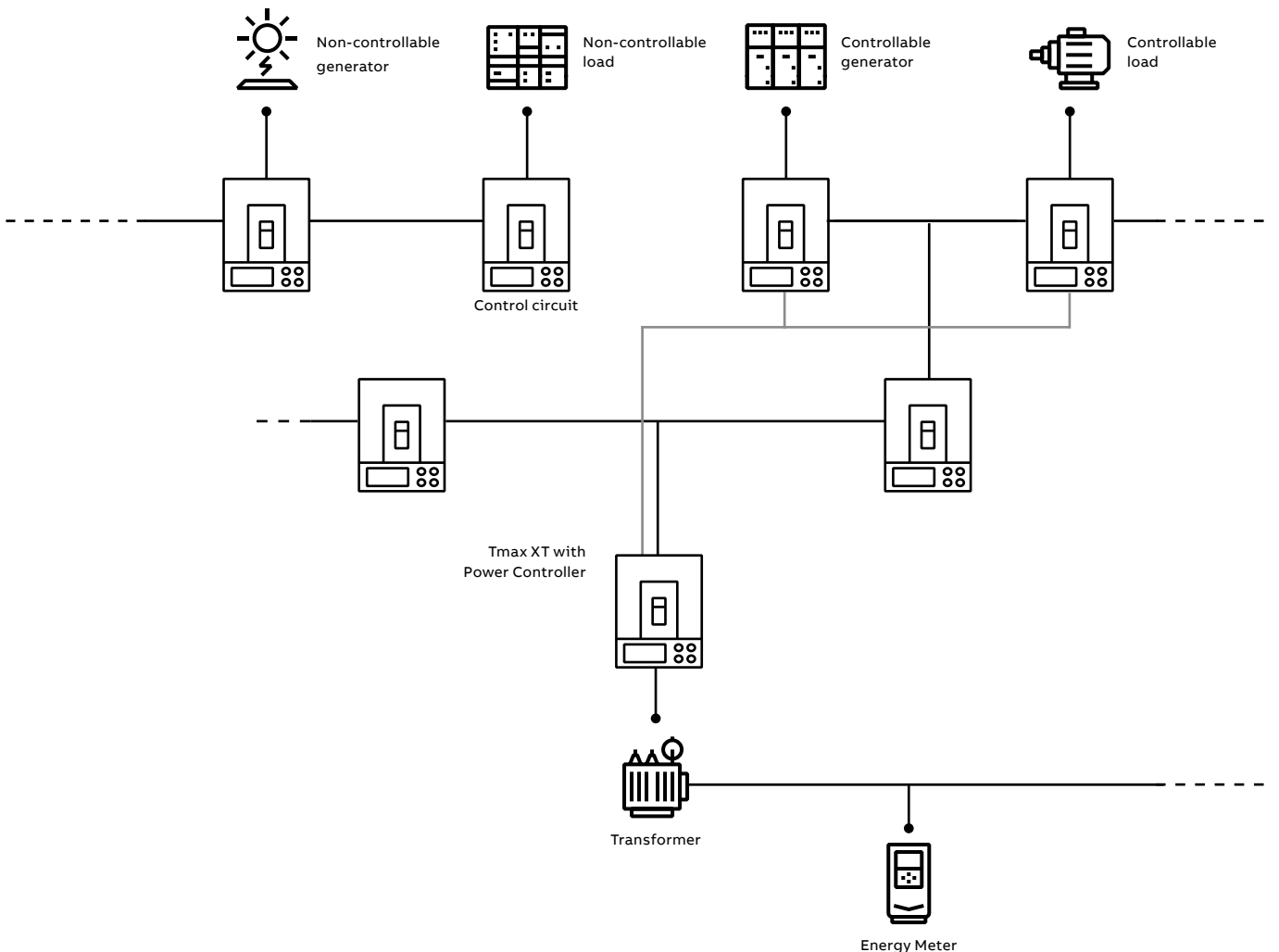

The Ekip Power Controller can be used with all Ekip Touch trip units of the Tmax XT series and effectively helps to improve energy efficiency by managing the entire low-voltage electrical system. It is fully able to adapt the demand for power according to the availability of the energy source, the time of day and the costs indicated in the current pricing plan.

In this way the Ekip Power Controller is able to maintain power consumption within the limits defined, thereby optimizing the costs of managing the installation and reducing emissions.

Commands sent to downstream devices can be performed in two different ways:

- through the wired solution, by commanding the shunt opening/closing releases or acting on the motor operators of the loads to be managed;
- through a dedicated communication system.

The ability to control the loads according to a list of priorities already defined provides significant advantages from both the economic as well as technical points of view:

- **Economic:** energy consumption optimization is focused on the control of the costs linked in particular to penalties that are levied when the contractual power is exceeded or when the contractual power is increased by the Distribution System Operator (DSO) as a consequence of exceeding the limit repeatedly.
- **Technical:** the solution provides the ability to absorb power over the contractual limits for shorter periods and also the management and the control of the power consumption over long periods of time. Thus, it is possible to reduce the likelihood of malfunctioning due to overloads, or worse, complete inefficiency of the entire plant due to tripping of the LV main switching device.

The exclusive Power Controller function available on the new Tmax XT units monitors the power, keeping it below the limits set by the user. As a result of this more effective use, the peak of power consumed can be limited allowing savings on electricity bills.

The Power Controller, patented by ABB, disconnects non-priority utilities, such as electric car charging stations, lighting or refrigeration units, during the times when consumption limits need to be respected, and connects them again as soon as it is appropriate. When required, it automatically activates auxiliary power supplies such as generator sets. No other supervision and control system is required: it is sufficient to set the required load limit on the Tmax XT, which can control any switching device located downstream, even if it is not equipped with a measurement function.

Application examples

Electricity bill savings, demand response, and avoiding power overloads are the typical scenarios where the Power Controller is used.

The Power Controller is commonly used in office buildings, shopping malls, hotels, campuses, waste and water industries or any plant that works like a low voltage microgrid.

Power Controller

Benefits

Thanks to the Tmax XT with embedded the Power Controller, the following benefits are guaranteed:

- **Reduction of energy costs with minimum impact**

The loads are disconnected from the power supply for short periods, in the minimum number necessary and in a fixed order of priority, enabling power consumption peaks to be limited. This allows the contract drawn up with the energy provider to be renegotiated, reducing the power allocated, with a consequent reduction in total energy costs.

- **Power limited only when necessary**

The Power Controller function manages up to four different time bands. It is therefore possible to respect a particular power limit according to whether it is during the day (peak) or night (off peak). In this way, consumption during the day when rates are at their highest can be limited.

- **Easy of use**

The Power Controller function allows the installation to be managed efficiently with a simple architecture. Thanks to a patented design, it is sufficient to measure the total power of the installation without having to measure the power consumed by each load. Installation costs and times are thereby reduced to a minimum.

The Power Controller function does not require the writing, implementation or testing of complicated programmes for PLC or computer because the logic has already been implemented in the protection unit and is ready to use. It is sufficient to set the installation parameters from a smartphone or directly from the switching device display.

Thanks to the integrated communication modules, the Power Controller can receive the maximum absorbable power directly from the medium voltage control system, determining consumption for the next 15 minutes. According to the information received, the Ekip Power Controller manages the switching off of non-priority loads or the switching on of reserve generators. The software gives maximum priority to non-programmable preferred energy sources, such as wind and solar, and they are therefore considered uninterruptable. In the event that the production of internal power to the controlled network is reduced, due, for example, to decreased production of solar power, the Power Controller will disconnect the necessary loads to respect the set consumption limit. This benefit is used, for example, in installations with a system of cogeneration. Indeed, the Power Controller controls the total consumption drawn from the electrical network, disconnecting non-priority loads when generation is reduced and reconnecting them when generator power is sufficient not to exceed limits. There are multiple advantages of the system including: reduction in energy costs, maximum use of local generation and greater overall energy efficiency.

Interface Protection System

The Tmax XT embeds both the functions of the Interface Protection System and Interface Device in a single device.

Purpose

The connection of active users to a power utility is always subject to Standard compliance. The Interface Protection System is a relay with dedicated protections that are able to satisfy these requirements. In particular, the generating units installed in the user's plant must be disconnected from the grid whenever the voltage and frequency values of the grid itself are out of the ranges prescribed by the Standards. This disconnection is usually carried out by means of an interface device that trips after receiving an opening command provided by an external interface protection system.

ABB has developed an integrated solution which embeds both the functions of ABB's Interface Protection System and Interface Device in a single device. This advanced feature is possible thanks to the integration of the several interface protections into the Ekip Hi-Touch trip unit installed on board the Tmax XT. Today the Tmax XT complies with the CEI 0-16 Standard, which is the most important Standard concerning the connection of active users. A lot of local Standards use the CEI 0-16 as a reference.

Application examples

ABB has been able to integrate the following functions in a single device to be used in the scenarios described below. Thanks to these embedded functions, the number of devices to be installed is reduced, with consequent space saving inside the switchboard. The Tmax XT with its embedded Interface Protection System have been tested and certified in compliance with the CEI 0-16 Standard and are suitable for the following scenarios.

The Tmax XT as the main protection unit for a microgrid

In such a scenario, the Tmax XT with its embedded functions can act as an Interface Protection System (IPS). In case of IPS tripping, the microgrid's main downstream Tmax XT unit remains active thanks to both the local generation and the load shedding feature also embedded in the main unit.

The Tmax XT as local generation protection unit

In this scenario, there are non-operating loads under islanding conditions, so, when there is a utility outage, the Tmax XT detects that the voltage and frequency values are out of the prescribed range. According to the CEI 0-16 Standard, local generation must be disconnected from the utility, so the Tmax XT opens, acting as interface device, thanks to the embedded IPS. In this condition, loads do not operate as there is no voltage on the secondary of the MV/LV transformer and no local generation connected.

Benefits

Thanks to the Tmax XT with the embedded Interface Protection System, the following benefits are guaranteed:

- The Tmax XT performs interface protection with any switching device, also ensuring reclosing operations.
- If the Tmax XT is installed on the generator feeder, the unit will be able to perform the dual function of an interface protection system and generator device thanks to the integrated Interface Protection System in the Ekip G Hi-Touch trip unit.
- Ease of use, thanks to the Ekip Connect software which allows an immediate and intuitive commissioning phase.

Interface Protection System

The Tmax XT as the main protection unit for a microgrid

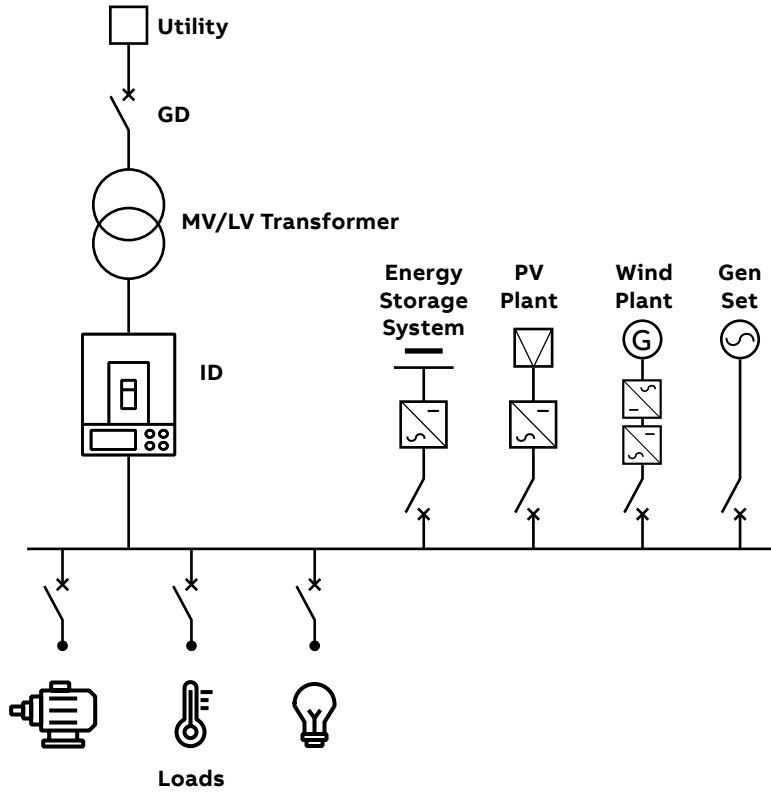

The Tmax XT as local generation protection unit

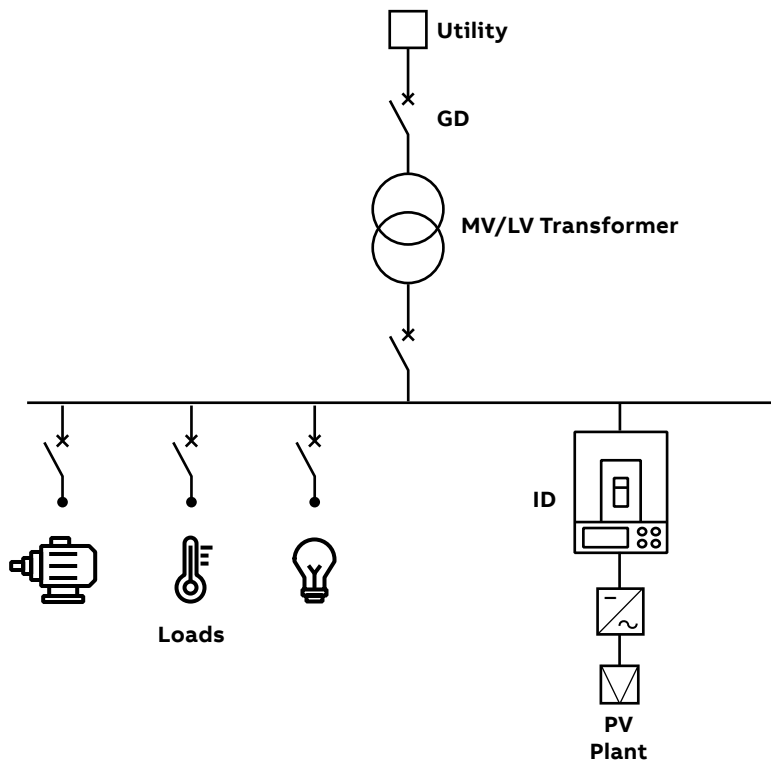

Adaptive Protections

The Tmax XT adds a dual setting capability to the switching device to ensure continuous coordination

Purpose

User's plants can work as an LV Microgrid thanks to the energy produced by renewable and local power sources, in particular as a consequence of the lack of a utility power supply, e.g. due to a fault on the MV voltage side. In order to still guarantee a high level of selectivity and continuity of service, it is important to take into account the variation of the short-circuit power when moving from on-grid to off-grid operation. Indeed, during grid connected conditions the fault current on a microgrid feeder is also supplied by the utility, thus resulting higher than the one supplied only by local generation during islanded conditions. As a result, it is desirable that several protection thresholds of the units can be automatically changed during the transition to islanding conditions.

Application example

A plant is connected to the MV utility by means of an MV/LV transformer. If the utility shuts down, the plant will become a microgrid supplied by a local generator G, which will feed priority loads by using the load shedding feature of the Tmax XT. In a grid-connected condition, the generator G is disconnected. With reference to Fig. 1:

- Circuit-breaker A is closed
- Circuit-breaker B is open
- Circuit-breakers at position C are closed. The protection of the circuit-breaker at C that supplies the feeders at D are adjusted using "Set A" of the Tmax XT unit.
- Circuit-breakers at position D are closed
- Circuit-breaker E is closed
- Switch-disconnector QS1 is closed
- All loads are supplied.

The circuit-breakers at position C are selectively coordinated with the upstream main circuit-breaker A, supplied by the utility, and the downstream load circuit-breakers at position D (see Fig. 2 at the following page).

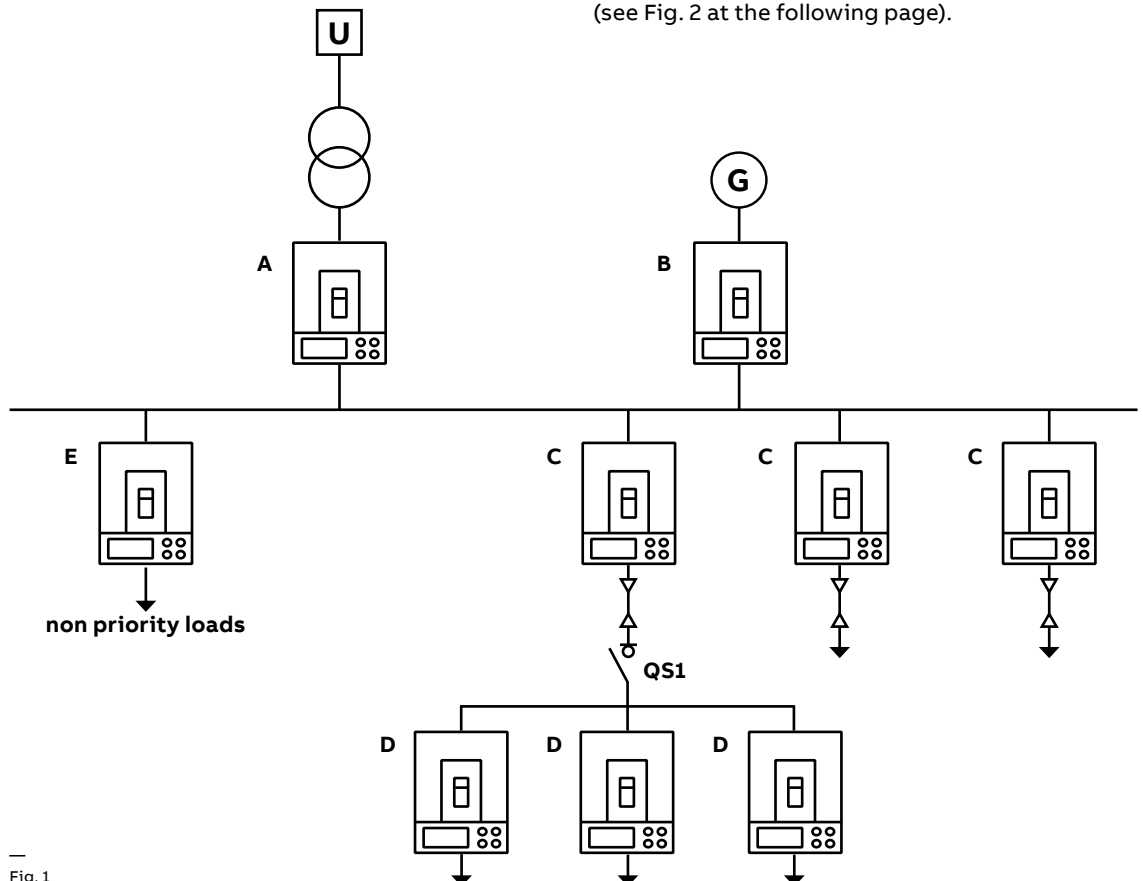

Fig. 1

Adaptive Protections

With the adaptive protections, when there is an utility outage, circuit-breaker A opens and B closes in order to achieve an islanded condition. In order to still guarantee selectivity, another set of protection settings is required. Adding Tmax XT adaptive protections to the circuit-breaker C1 ensure this behaviour. The second protection setting is optimized for the characteristics of the local generator ensuring the incoming supply. Additionally, selective coordination with the load side switching devices is also guaranteed.

With reference to Fig. 1:

- Circuit-breaker A is open
- Circuit-breaker B is closed
- Circuit-breakers at position C are closed and the protection thresholds move automatically to "Set B"
- Circuit-breakers at position D are closed
- Circuit-breaker E is open
- Switch-disconnector QS1 is closed
- Non-priority loads can be disconnected using another functionality of the Tmax XT units (see next paragraph).

Fig. 3 shows how it is possible to switch to a set of parameters which guarantees selective coordination between circuit-breakers C and B by means of the Adaptive Protection function embedded in the trip unit of the C circuit-breakers.

Benefits

Thanks to the Tmax XT it is possible to have two sets of settings implemented in a single device. As a result, the following benefits are guaranteed:

- Overcurrent protection and selectivity 100% guaranteed both in grid-connected and islanded conditions.
- Service continuity is guaranteed by just adding a single unit to the switchboard in every plant condition.
- Ease of use, thanks to the Ekip Connect software which allows an immediate and intuitive commissioning phase.

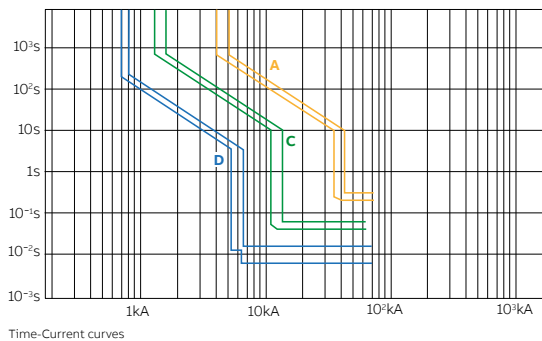

Fig. 2 - Protection thresholds during on-grid operation

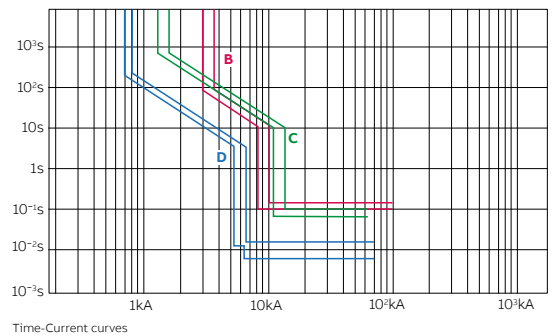

Fig. 3 - Protection thresholds during islanded operation

Load Shedding

The Tmax XT has many load shedding algorithms to avoid power unbalance in low voltage plants and to reduce stress for all the components.

Purpose

The Tmax XT embeds patented functions based on load shedding which reduce the microgrid stress in all situations. Typically, it is the main protection relay of the low voltage microgrid located at the interface point with the medium voltage grid, that is able to control the plant in all circumstances.

A microgrid under islanding conditions

After the the Tmax XT circuit-breaker opens, due to the interface protection system intervention or external command, the microgrid should seamlessly transition from an on-grid to off-grid state. When it operates in a stand-alone capacity, the power absorption from the main grid ceases, so that the microgrid loads remains supplied by local generation, such as from a diesel GenSet or an energy storage system. This microgrid generation can be always active or started up by Automatic Transfer Switching (ATS) logic after the disconnection from the main grid, depending on the plant configuration. During the islanding transition, it is very important to avoid a frequency drop, otherwise the generation protections could trip and jeopardize the microgrid stability with a consequently long downtime. The Tmax XT employs current and voltage measurements, and integrates two different fast load shedding types of logic to reduce this blackout risk. This protects the microgrid during intentional or unintentional islanding operations:

- The Basic Load Shedding algorithm is a simple form of logic able to recognize the microgrid disconnection event and shed a group of not priority loads thus ensuring a fast time response and power balance.
- The Adaptive Load Shedding algorithm is an advanced algorithm available with the Tmax XT as an enhancement of the basic version. The intelligent software embedded in the unit sheds the non-priority loads very quickly according to the microgrid power consumption and frequency measurements. Moreover, the software has a dedicated configuration for backup generation related to Automatic Transfer Switching (ATS) and the software itself is even able to estimate the energy produced by a solar plant based on the plant geography settings.

A microgrid in grid-connected conditions

Under normal circumstances, the microgrid is generally connected to the utility in order to inject/adsorb surplus or shortfalls of energy. In this situation, with the Tmax XT as the main circuit-breaker installed immediately downstream of the MV/LV transformer in a closed status, power overload should be avoided so as not to excessively stress the plant elements. In order to do this, the circuit-breaker embeds a patented load shedding algorithm:

- The Predictive Load Shedding algorithm is a slow disconnection of loads based on the limit of the average power flow towards the microgrid according to the transformer size designed for the power peak profile.

All three Load Shedding versions are available on the Tmax XT platform for both microgrid situations, sharing some information about the loads under control in the plant.

Application examples

- **Grid-connected plants with running GenSets**
These contribute to self-consumption together with potential renewable sources and support the load power supply in emergency conditions. This is the case for hybrid photovoltaic diesel remote communities connected to weak distribution grids where there are a lot of daily faults, or facilities located in geographical areas where there are frequent environmental events, for example hurricanes or earthquakes.
- **Grid-connected plants with back-up GenSets**
These are started up after main generator transfer switching logics and require high reliability. For example, hospitals, banks or data centers.

Benefits

Thanks to Tmax XT with the embedded Load Shedding innovations, the following benefits are guaranteed:

Service continuity

- When a plant remains disconnected from the main grid, even if local generation is present, there is a significant stress that may mean the generators fail with a consequent blackout. Load Shedding logic embedded in the Tmax XT reduces the frequency drop that usually makes the local generation protection trip, maintaining a live plant.

Load Shedding

Space saving

- No other programmable logic controllers (PLCs) are needed as the Tmax XT has embedded intelligence for the load shedding logics, taking advantage of the current and voltage sensors for electrical parameter measurements.
- In addition, static converters for low voltage photovoltaic production typically have anti-islanding protection: this implies another power deficit to be added to the main grid contribution during the microgrid islanding. The Tmax XT estimates solar production without additional sensors.
- The Load Shedding algorithm is suitable with ATS architectures like Main-Bus Tie-Gen used to distinguish priority and non-priority loads. Where feasible, a BusTie switching device is no longer required and this means:
 - Significant space and material savings of up to 50% in the power distribution switchgear for panel builders.

- The Load Shedding algorithm is self-tuned with specific power unbalance identification and dynamically chooses the controllable loads to be shed, reducing constraints for consultants during plant design.
- The ATS unit only manages two sources, without interlock, logic programming or wiring connections for the third circuit-breaker with less time required for installation.

Ease of use

Load shedding logic is generally set using top engineering skills and customization efforts with devices as programmable logic controllers. The Tmax XT guarantees easy installation thanks to predefined templates and the user-friendly graphic interface in the software commissioning tool.

Typical Load Shedding application

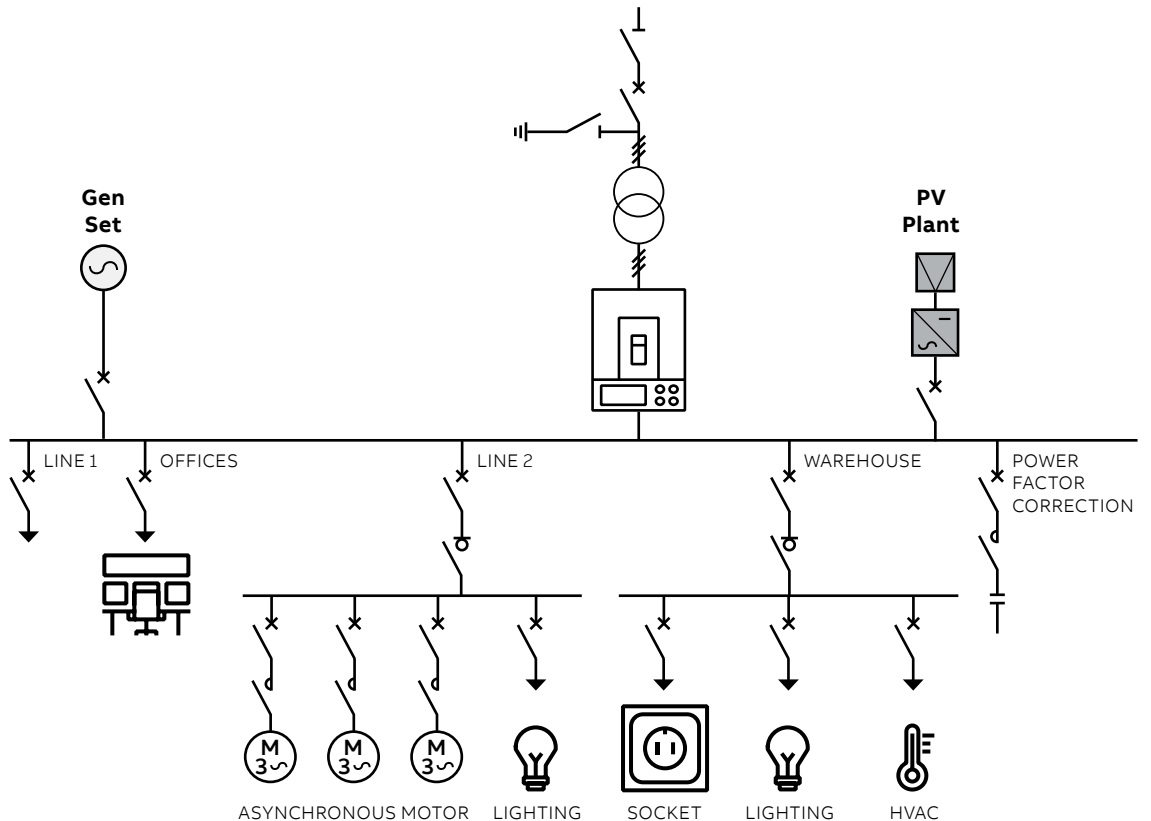

Automatic Transfer Switch

The Tmax XT is ready for transfer switching applications reducing time for logic programming and commissioning.

The ATS solution

ABB Automatic Transfer Switch system (ATS) takes advantage of the new capabilities provided by the new Ekip Connect 3 Software with intelligent digital units such as the Tmax XT to deliver versatile and reliable solutions.

Application example

Automatic transfer switch systems are common in all applications where service continuity is essential and where there are multi source supplies.

The main applications are:

- Power supplies of UPS groups
- Oil & Gas
- Operating theatres and primary hospital services
- Emergency power supplies for civil buildings, hotels and airports
- Data banks and telecommunication systems
- Power supply of industrial line for continuous processes.

An ATS can be used also whenever a portion of a grid with local generation, known as a microgrid, can be disconnected from the main grid.

ATS application example

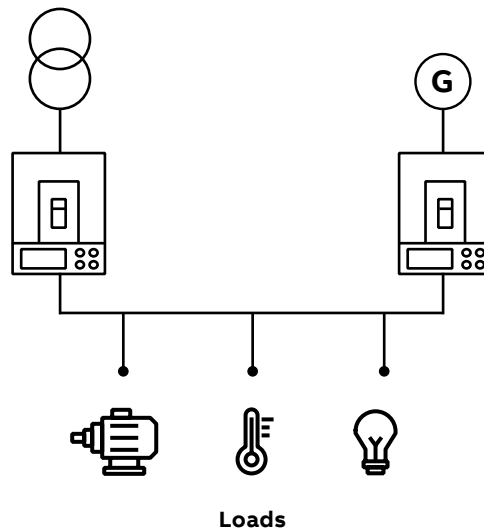

Automatic Transfer Switch

The ATS is a high-performing energy automation system, easy to install and program.



Benefits

Ready-to-go programming

Estimated time and cost savings on the ATS engineering on a low voltage project: 95%.

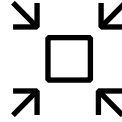

Tmax XT compactness

Space saving on the power switchboard: up to 30%.



Simplify the connections

Estimated time and cost savings on cabling and commissioning of the power switchboard: 50%.



Top rate reliability

With watchdog functions and fewer installed components.

Synchro Reclosing

The Tmax XT is able to synchronize voltage waveforms from different power sources.

Purpose

Thanks to its advanced electronics, the Tmax XT is a smart unit which is able to island the microgrid from disturbances such as in the presence of faults or power quality events and reconnect it to the distribution network once perfect conditions are guaranteed.

This feature is the Synchro Reclosing function. This consists of synchronization support of the microgrid reconnection operation or generator parallel procedures as described by ANSI protection Code 25A, with additional automatic reclosing capabilities based on synchronism status detection.

Using the Ekip Synchrocheck cartridge module, the Tmax XT monitors the voltage amplitude, frequency and phase displacement and implements simple logic to adapt the microgrid voltage and frequency to the main grid. This regulation is based on up and down signals sent to the local generator controllers and is implemented via the Ekip Signalling contacts. The circuit-breaker automatically recloses when it understands that the synchronism has been achieved using the Ekip Synchrocheck and the integrated closing coil.

Sometimes this operation can be very critical because the current following during the transient of the reconnection must not reach values that can potentially cause the microgrid shut down. With the aim of avoiding complex analysis and customizations, the Ekip Connect 3.0 commissioning tool completes the Synchro Reclosing functionality and recommends the appropriate settings according to the plant configuration.

Application examples

The Synchro Reclosing function is useful in the following plant-engineering situations:

- During a reconnection of the microgrid to the main grid, speeding up a parallel procedure between two systems with different steady states. This scenario comes after an islanding microgrid operation.
- When there is a closed transition of an automatic transfer switch, the main grid should be connected to the same busbar with backup microgrid generation in order to guarantee continuous load operation, with or without a bus-tie switching device.
- In addition to microgrid cases, it is possible to adopt this solution also for single GenSet parallel operations.

Synchro Reclosing application example

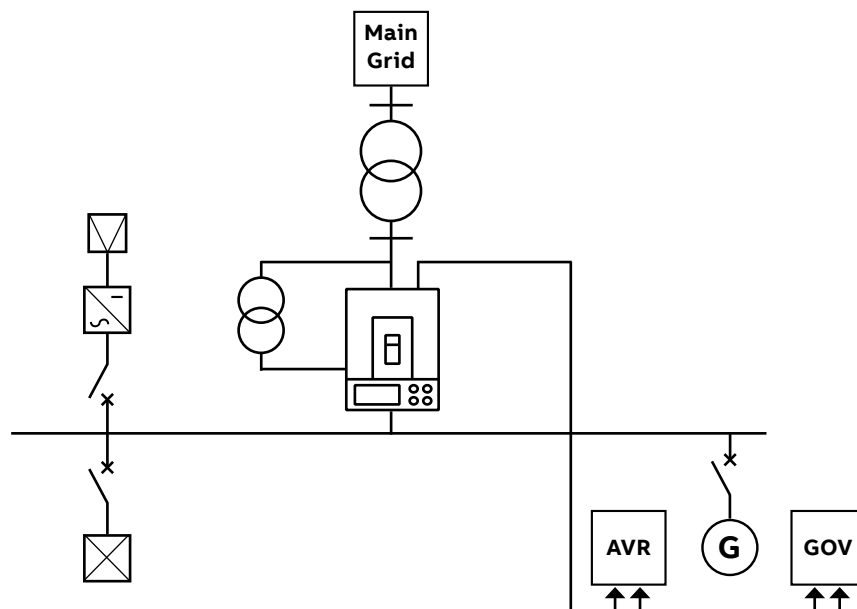

Synchro Reclosing

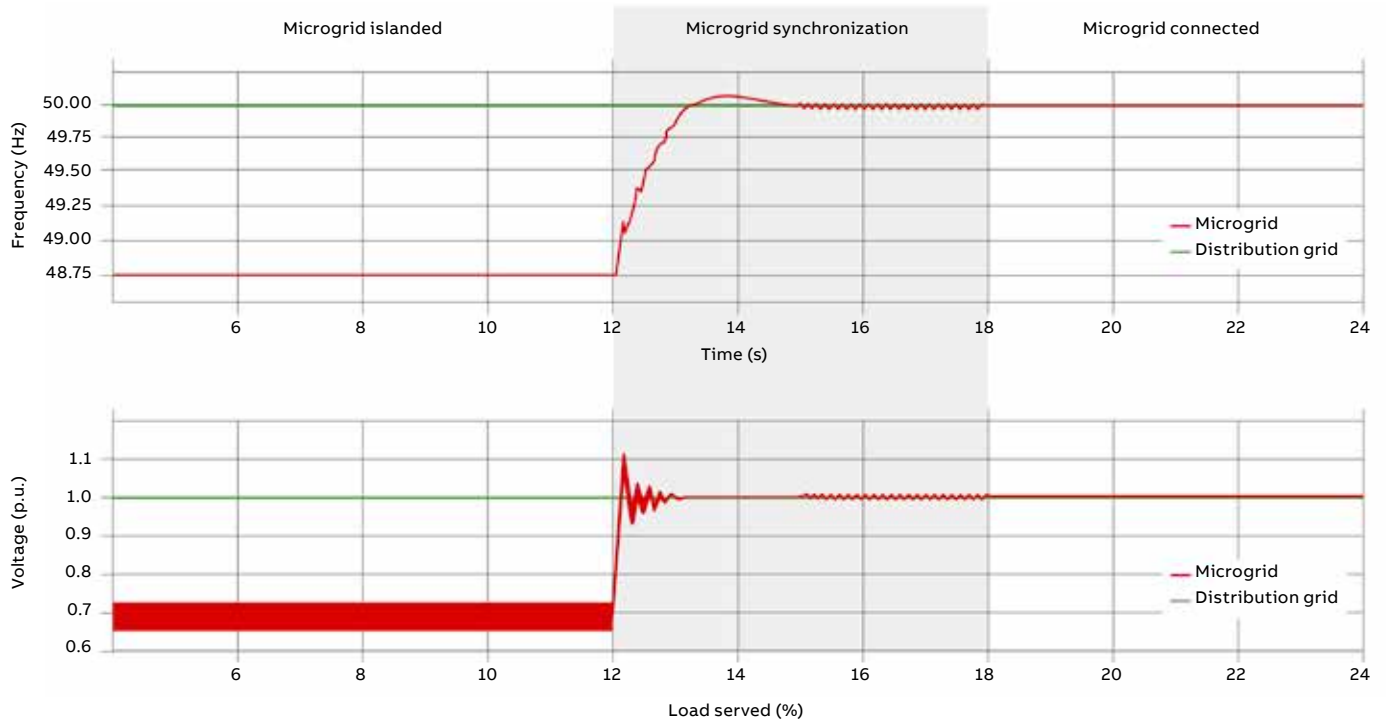

Benefits

Thanks to the Tmax XT with its embedded Synchro Reclosing function, the following benefits are guaranteed:

Space saving

- Components reduction with no external synchronizer and less voltage transformers required compared to traditional approaches.
- Increased reliability and time saving during the installation with less cabling and related installation complexity.

Ease of use

- The logic is embedded in the trip unit so there is no need for programming or engineering skills.
- Simplified configuration with Ekip Connect software offers predefined configuration templates with suggested values and a clear user interface for customization.

Accessories

Execution and installation

- 7/2 Fixed, plug-in and withdrawable version
- 7/4 Conversion kits
- 7/6 Connectors for electrical accessories
- 7/7 Bracket for fixing on DIN-rail
- 7/7 Motorizable version

Power connection

- 7/8 Connection terminals

Signaling

- 7/17 Auxiliary contacts - AUX
- 7/24 Auxiliary Position Contacts - AUP
- 7/26 Early Auxiliary Contacts - AUE
- 7/27 Ready to close signaling contacts - RTC
- 7/27 Contact signaling loaded springs - S33 M/2
- 7/27 Mechanical signaling of tripping the protection nit - TU Reset

Operating mechanism

- 7/28 Rotary handle operating mechanism
- 7/29 Telescopic Rod - RHE_ST
- 7/30 Front for the lever operating mechanism
- 7/30 Toggle extension

Remote control

- 7/31 Service releases
- 7/36 Resetting from remote - YR
- 7/36 Opening and closing release test unit - YO/YC Test Unit
- 7/37 Electronic time-delay device for undervoltage release - UVD
- 7/37 Motor Operators
 - 7/37 Direct action motor operator - MOD
 - 7/39 Stored energy motor operators - MOE and MOE-E (XT2-XT4)
 - 7/40 Stored energy motor operators - MOE and MOE-E (XT5-XT6)
 - 7/42 Motor - M

Safety and protection

- 7/43 Terminal covers
- 7/43 Phase separators
- 7/43 Sealable screws for terminal covers
- 7/44 Padlocks and key locks
- 7/47 IP Protection Kit
 - 7/47 IP54 Protection for transmitted rotary handle (RHE)
 - 7/47 IP54 Protection flange for direct rotary handle (RHD)
 - 7/47 IP54 Protection flange for MOE and XT7 M
- 7/48 Protection device for opening and closing pushbuttons - PBC
- 7/48 Mechanical operation counter - MOC
- 7/48 Flanges

Interlocks and switching devices

- 7/49 Rear mechanical interlock
- 7/50 Cables interlocks
- 7/51 Automatic network-generator transfer unit ATSO21-ATS022

Residual current protection

- 7/53 Residual current release

Compatibility of accessories

Execution and installation

Fixed, plug-in and withdrawable version

SACE Tmax XT circuit-breakers are available in the following versions:



Fixed circuit-breaker



Plug-in circuit-breaker



Withdrawable circuit-breaker

- **FIXED**

Fixed circuit-breakers consist of a current-interrupting part connected to the trip unit, to be installed on the back plate of the cubicle or on a DIN-rail;

- **PLUG-IN**

Plug-in circuit-breakers consist of a fixed part that must be installed on the back plate of the cubicle, and of a moving part, obtained from the fixed circuit-breaker plus the relative kit that converts it from the fixed version into the moving part of the plug-in version;

- **WITHDRAWABLE**

Withdrawable circuit-breakers consist of a fixed part that must be installed on the back plate of the cubicle equipped with side runners to allow the moving part to be easily racked -in and -out. Such a solution is obtained from the fixed circuit-breaker plus the relative kit that converts it from the fixed version to a withdrawable moving part. To obtain the withdrawable version, a front accessory to be applied to the front of the circuit-breaker must be ordered so as to maintain the IP40 degree of protection over the entire disconnection run of the circuit-breaker (except for the XT7). This mandatory accessory is a standard supply for circuit-breakers fitted with accessories in the factory.

If the plug-in circuit-breaker is fitted with electrical accessories, the appropriate connectors for disconnection of the relative auxiliary circuits must also be ordered. For the withdrawable version there are dedicated accessories, fitted with connectors, which allow automatic disconnection in the case of racking-out.

Starting from the fixed version, the SACE Tmax XT circuit-breakers can be easily converted into plug-in and withdrawable versions by using the relative conversion kits.

The moving parts can always be obtained for the required version, fully pre-engineered from the factory, by ordering the fixed circuit-breaker and the conversion kit at the same time.

	Version		
	Fixed	Plug-in	Withdrawable
XT1	■	■	-
XT2	■	■	■
XT3	■	■	-
XT4	■	■	■
XT5	■	■	■
XT6	■	-	■ ⁽¹⁾
XT7	■	-	■
XT7 M	■	-	■

(1) In max = 800A, not suitable for XT6 1000A

The fixed version, which is connected directly to the power system through the circuit-breaker terminals, is recommended for applications in which the need for space can be satisfied by compact products without affecting the performance.

The plug-in version is recommended for applications for which service continuity is a fundamental requirement: the replacement of the moving part with a new one does not require any intervention on the power supply connections.

The withdrawable version, in addition to the advantages of the plug-in version, offers three different positions:

- connected: power and auxiliary circuits are connected
- test: power circuits are disconnected, while auxiliary circuits are connected (only for XT5, XT6 and XT7)
- disconnected: both power and auxiliary circuits are disconnected.

Fixed part of plug-in and withdrawable versions

The fixed part of the plug-in/withdrawable versions is available with front terminals (EF), with horizontal rear terminals (HR) or with vertical rear terminals (VR). The terminals are factory mounted in the horizontal position if the code is shared between HR and VR. In this case, it is possible to easily rotate the terminals into the vertical position. For the XT5 and XT6 circuit-breakers, the fixed part can be fully pre-engineered in the factory, with the required combination of terminals, by ordering the dedicated configurable fixed part code and the terminals at the same time.

These fixed parts can be equipped with the same terminals, terminal-covers and phase separator kits used for the fixed circuit-breakers, using the proper adapter (see the "Power connection" section). For the Tmax XT1, XT2, XT3, XT4, XT5 and XT6, the fixed part of a plug-in/withdrawable circuit-breaker can be installed at two different distances from the back of the panel, according to the picture below. For the XT1, XT2, XT3 and XT4, installation at 50mm is only compulsory in the case where rear horizontal or vertical terminals (HR/VR) are used.

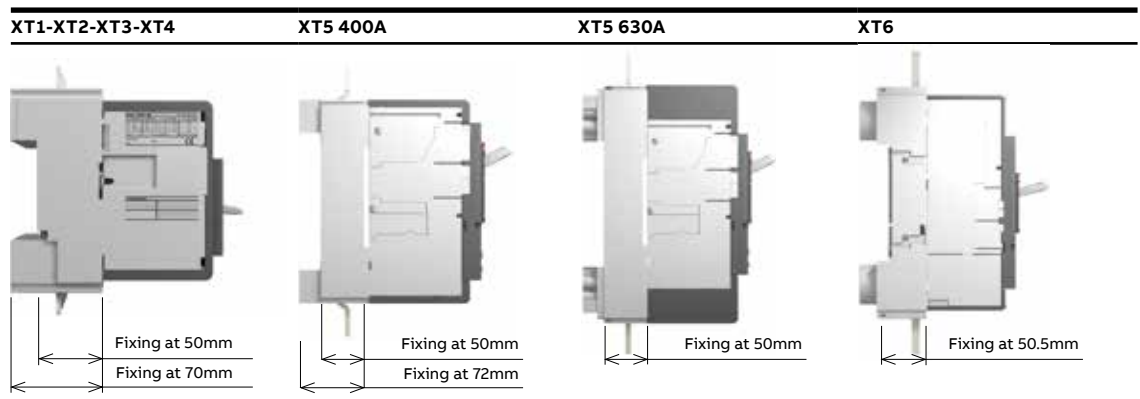

Execution and installation

Conversion kits

The following conversion kits can be ordered for the different versions. This is applicable the whole Tmax XT family, up to Tmax XT6.



Conversion kit for converting a fixed circuit-breaker into the moving part of a plug-in circuit-breaker

- **Kit for converting a fixed circuit-breaker into the moving part of plug-in/withdrawable versions**

The conversion kit converts a fixed circuit-breaker into a moving part of the plug-in/withdrawable versions. When withdrawable versions are required, it is essential to order an accessory for the front of the circuit-breaker to maintain the IP40 degree of protection along the entire insulation run. This accessory is made of the following options:

- front for the lever operating mechanism (FLD);
- motor operator (MOE);
- direct or transmitted rotary handle operating mechanisms (RHD or RHE).

In the case where no accessory to be applied onto the front is indicated, the front for the lever operating mechanism (FLD) is automatically included in the order.



Conversion kit for converting a fixed circuit-breaker into the moving part of a withdrawable circuit-breaker

- **Kit for converting a fixed part of a plug-in version into the fixed part of withdrawable versions**

The kit comprises:

- a guide for transforming the fixed part of the plug-in circuit-breaker into a fixed part of a withdrawable circuit-breaker;
- a racking-out lever that allows the moving part to be inserted and withdrawn. The mechanism allows the circuit-breaker to be set to the disconnected position (with the power and auxiliary circuits disconnected) with the compartment door closed, which is an advantage for operator safety. The rotary handle can only be inserted when the circuit-breaker is open. Once it has been removed or withdrawn, the circuit-breaker can be set to the open/closed position;
- a flange for the compartment door, which replaces the one supplied with the fixed version of the circuit-breaker.



Conversion kit for converting a fixed part of plug-in version into the fixed part of a withdrawable version

- **Kit for converting a fixed circuit-breaker into the plug-in version for RC Sel residual current devices for XT2-XT4-XT5**

The RC Sel 4-pole residual current devices for the XT2, XT4 and XT5 can be converted from fixed versions to plug-in versions using the special kit.

- **Kit for converting plug-in circuit-breakers into withdrawable versions for RC Sel residual current devices for the XT2-XT4-XT5**

The RC Sel 4-pole residual current devices for the XT2, XT4 and XT5 can be converted from the plug-in version to the withdrawable version using a special kit, which includes a component to apply to the front of the residual current device so as to allow it to be withdrawn when the panel door is closed. This kit can also be assembled on fixed circuit-breakers equipped with a front for a lever operating mechanism or the direct rotary handle, thus allowing the use of residual current devices.

In the plug-in to withdrawable conversion kit, there are also PIN connectors to be applied onto the right side of the circuit-breaker to facilitate disconnection of the auxiliary circuits connected to the residual current device.

For the XT1, XT2, XT3 and XT4, this kit also contains the opening solenoid of the residual current device dedicated to the withdrawable version, which is fitted with a connector for the fixed part and the moving part.

For the SACE Tmax XT7 and XT7 M there is a dedicated conversion kit to transform a fixed circuit-breaker into the moving part of the withdrawable version. No additional accessory is required.

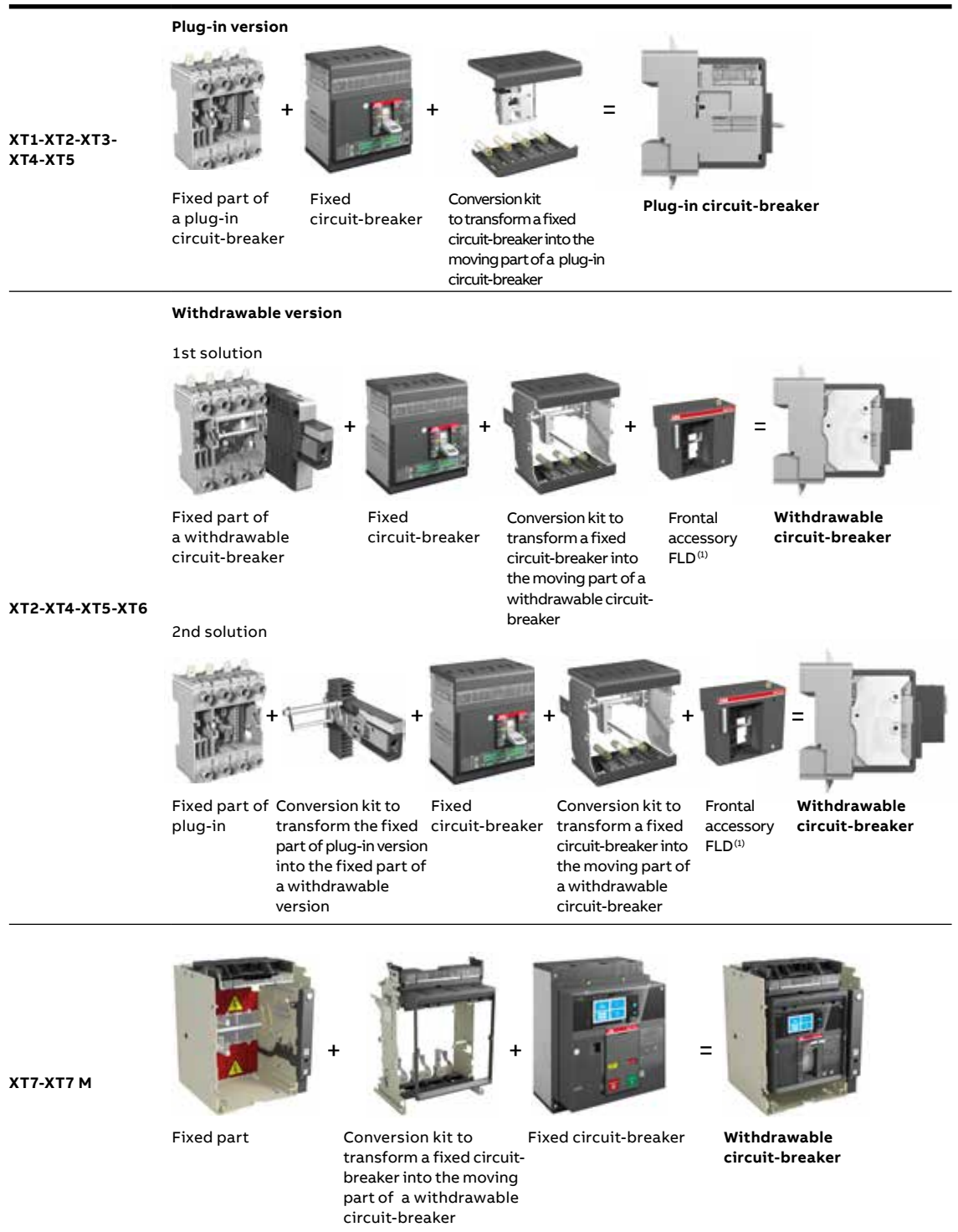

(1) Frontal accessory mandatory. If not specified in the order, the FLD is supplied automatically

Execution and installation

Connectors for electrical accessories

Plug-in circuit-breaker

In the plug-in version of the SACE Tmax XT circuit-breakers, the auxiliary circuits can be disconnected by means of two different types of adapter:

- a plug and socket to be fixed on the bottom of the panel: for the XT1, XT2, XT3, XT4 and XT5;
- a plug and socket installed on the rear of the circuit-breaker and in the fixed part of the plug-in devices: for the XT2, XT4 and XT5.

Plug and socket on the back of the panel

To make it easier to connect/disconnect the auxiliary circuits, wired electrical accessories can be connected to one or more plug and socket connectors on the back of the panel.

3, 6, 9 and 15 PIN connectors are available. The cables connect/disconnect the auxiliary circuits in a fast and simple way without the aid of any dedicated tools.

Consider the number of cables of each electrical accessory when calculating the number of connectors required.



Plug and socket adapters on the back of the panel

Number of cables	XT1-XT2-XT3-XT4 accessories	XT5-XT6 accessories
2	SOR, UVR / External Neutral Ekip Dip trip units / PTC for Ekip M-LRIU / Ekip Com Modbus RTU / Ekip Com Modbus TCP STA	YO, YU / Ekip Com Modbus RTU / Ekip Com Modbus TCP STA
3	RC Coil / 1 AUX	1 AUX
4	24V DC/Internal bus cable / Ekip Com Modbus RTU STA / AUE	24V DC/Internal bus cable / Ekip Signaling 1K / Ekip Com Modbus RTU STA / Ekip Maintenance Module / AUE
5	MOE-E / Selectivity cable	Selectivity cable
6	Ekip Com ⁽¹⁾ / Residual current device	Residual current device, MOE-E
7	MOE (with AUX-MO) / MOD (with AUX-MO)	-
8	-	MOE (with AUX-MO)

(1) Ekip Com for Ekip LSI, LSIG and M-LRIU

Plug and socket adapters on the rear of the circuit-breaker and inside the fixed part

For the plug-in versions of the XT2, XT4 and XT5 circuit-breakers, the auxiliary circuits can be automatically disconnected by means of an adapter installed on the rear of the circuit-breaker and inside the fixed part of plug-in versions.

The 12 PIN connector can be used only with accessories functioning at a voltage lower than 250V AC/DC.

The cables connect/disconnect the auxiliary circuits in a fast and simple way without the aid of any dedicated tools. Wiring is to be carried out by the Customer.



Plug and socket adapter placed on the back of the moving part



Plug and socket adapter in the fixed part

Circuit-breaker	Number of plugs and sockets installed on the rear of the circuit-breaker and inside the fixed part
XT2-XT4	1
XT5	2



—
Cabling of withdrawable versions

Withdrawable circuit-breaker

When withdrawable circuit-breakers are used, the codes of the electrical accessories specifically designed for this version must be ordered. These dedicated codes include the wired electrical accessory with a connector for the moving part and for the fixed part to be inserted on the side of the fixed part. If the MOE motor operator is ordered, connectors for the fixed part and moving part are always supplied since there is no dedicated code for the withdrawable version. This type of connection allows the auxiliary circuits to be disconnected automatically when the circuit-breaker is withdrawn from the fixed part. If cabling of the fixed part is required before wiring the moving part, the fixed part mounting connectors can be ordered as spare parts.

XT7 and XT7 M

Two different areas for the auxiliary connection terminal boxes can be clearly identified on the top of the XT7 and XT7 M circuit-breakers:

- The terminal area housing the terminals for wiring the auxiliary connections. The terminals can be wired first and then installed in the circuit-breaker terminal box, thereby facilitating cable connection for the operator;
- The cartridge modules area, housing the Ekip modules. These are installed directly on the upper part of the circuit-breaker without removing the Ekip electronic trip unit, thereby minimizing the time required for the installation and commissioning of accessories.

These areas are the same also in case of withdrawable versions.

Bracket for fixing on DIN-rail

This is a support designed to be installed on the back of the circuit-breakers to simplify assembly on standardized DIN EN 50022 rails.

The following circuit-breakers can be installed on the DIN EN 50022 rail:

- XT1, XT2, XT3 and XT4 circuit-breakers in the fixed 3-pole or 4-pole versions;
- XT1, XT3 circuit-breakers equipped with RC Sel 200; RC Inst, RC Sel for XT1 and XT3 residual current releases.



—
Bracket for fixing on DIN-rail

Motorizable version

The XT7 M can be equipped with a spring charging motor. To allow complete remote control with the XT7 M, the circuit-breaker must be fitted with:

- A shunt opening release (YO)
- A shunt closing release (YC)
- A spring charging motor (M)



—
Tmax XT7 M

Power connection

Power connection		XT1	XT2	XT3	XT4	XT5	XT6	XT7	XT7 M
Terminals for circuit-breaker	F - Front	■	■	■	■	■	■	■	■
	EF - Front extended	■	■	■	■	■	■	■	■
	ES - Front extended spread ⁽¹⁾	■	■	■	■	■	■	■	■
	FCCu - Front for copper cables ⁽¹⁾	■	■	■	■	-	-	-	-
	FCCuAl - Front for copper/aluminium cables ⁽¹⁾	■	■	■	■	■	■	■	■
	FB - Flexible busbars ⁽¹⁾	■	■	■	■	-	-	-	-
	MC - Multi-cable ⁽¹⁾	■	■	■	■	-	-	-	-
	R - Rear orientated	■	■	■	■	■	■	-	-
	HR/VR - Rear orientable terminal	-	-	-	-	-	-	■	■
Terminals for fixed part	EF - Extended front for fixed part	■	■	■	■	■	■	■	■
	HR/VR – Horizontal/vertical rear for fixed part ⁽²⁾	■	■	■	■	■	■	■	■
	ES - Extended spread front for fixed part	-	-	-	-	-	-	■	■
	SHR - horizontal rear spread terminals for fixed part	-	-	-	-	-	-	■	■
	FCCuAl – Front copper/aluminium cables for fixed part	-	-	-	-	-	-	■	■
Terminals for Residual current Device	HR for RC - for residual current release	■	-	■	-	-	-	-	-

(1) From the XT1 to XT6, the same terminals of fixed circuit-breakers can be mounted on the fixed part if the adapter is installed.
(2) For the XT5 630A fixed part, the HR and VR have different codes

Connection terminals

Connection terminals allow the circuit-breaker to be connected to the system in the way most suitable for the installation requirements. They consist of:

- front terminals: for connecting cables or busbars directly from the front of the circuit-breaker;
- rear terminals: for installing circuit-breakers in segregated panels with rear access.

Where possible, the terminals have a laser marking on the surface indicating the tightening torques for the correct insulation of cables and bars.

Fixed version

The standard fixed version of the SACE Tmax XT circuit-breakers are supplied with front terminals (F). However, they can be fitted with the following types of terminals as accessories thanks to the special kits:

- extended front (EF);
- extended spread front (ES);
- front for copper/aluminium cables (FCCuAl). A pitch adapter must be applied to the terminal zone of the circuit-breaker to ensure that copper and aluminium cables can be connected to all the circuit-breakers. The pitch adapter is automatically supplied when it is necessary;
- front for copper cables (FCCu);
- for flexible busbars (FB);
- multicable (MC);
- rear oriented (R).



Fixed part adapters

Plug-in and withdrawable versions

The fixed part of the plug-in and withdrawable versions of the XT1, XT2, XT3 and XT4 circuit-breakers are normally supplied with extended front terminals (EF) or horizontal/vertical rear terminals (HR/VR).

The terminals are factory-mounted in the horizontal position. If needed, the customer can easily rotate the terminals into the vertical position.

A fixed part with front terminals (EF) can be converted into a fixed part with rear terminals (HR/VR) by ordering the appropriate terminal kit.

The fixed part of the plug-in and withdrawable versions of the XT5 and XT6 circuit-breakers can be accessorized directly when ordering with extended front terminals (EF) or horizontal/vertical rear terminals (HR/VR), that can be different from the top and bottom terminals.

The terminals are factory-mounted in the horizontal position. If needed, the customer can easily rotate the terminals into the vertical position. For the XT5 630A fixed part, the HR and VR terminals are different and not interchangeable.

The fixed parts can also be fitted with the same types of terminals available on the fixed circuit-breaker after an adapter has been installed on the terminal area of the fixed part itself. Consequently, the following types of connection terminals are also available for the fixed part:

- extended spread front (ES);
- for copper-aluminium cables (FCCuAl);
- for copper cables (FCCu);
- for flexible busbars (FB);
- multi-cable (MC).

The adapter reproduces the terminal area of the fixed circuit-breaker. This means that the fixed parts can also be equipped with the same terminal covers and phase separators as those used for fixed circuit-breakers.

In order to mount terminals on the adapter, the front terminals "F" kit provided with the CB is needed.

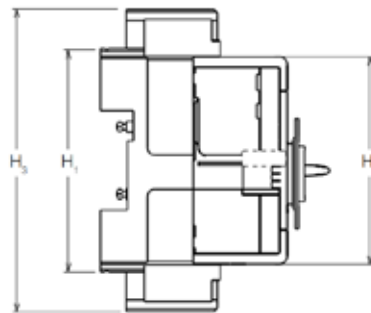

Fixed part adapter

Circuit-breakers	H1 fixed part [mm]	H2 circuit-breaker [mm]	H3 fixed part with two adapters [mm]
XT1	146	134	181
XT2	153	134	188
XT3	166	154	225
XT4	182	164	228
XT5 400A	209	209	283
XT5 630A	273	273	347
XT6	295	273	408

For the XT7 and XT7 M, dedicated terminals for fixed part must be ordered.

Power connection

Terminals for circuit-breaker

Front terminals - F



Front terminal - F



F terminal with cable lug



F terminal with busbar

CB	Vers.	Busbars dimensions						Cable terminals			Tightening		H Terminal covers				H Separators		
		[mm]						[mm]					[mm]				[mm]		
		Wmin	Wmax	H	Ø	Dmin	Dmax	W	Ø		Cable or busbar/terminal	2	50	60	68	25	100	200	
XT1	F	13	16	7.5	6.5	3.5	5	16	6.5	M6	6Nm	-	R	-	-	S _{CB}	R	R	
XT2	F	13	20	7.5	6.5	2.5	5	20	6.5	M6	6Nm	-	R	-	-	S _{CB}	R	R	
XT3	F	17	24	9.5	8.5	5	8	24	8.5	M8	8Nm	-	-	R	-	S _{CB}	R	R	
XT4	F	17	25	10	8.5	5	8	25	8.5	M8	8Nm	-	-	R	-	S _{CB}	R	R	
XT5	F	25	35	12	10.5	5	10	35	10.5	M10	28Nm	R	-	R	-	S _{CB} ⁽²⁾	R	R	
XT6 ⁽¹⁾	F	40	50	12	2x7	5	5	50	2x7	M6	9Nm	R	-	R	-	-	R	R	
XT7 - XT7 M	F	40	50	20	2x11	1x10	2x10	2x24	2x11	M10	18Nm	R	-	-	R	-	R	R	

(1) Not available for the XT6 1000A

(2) Phase barriers 25 mm are mandatory according indications on instructions sheet

Extended front terminals - EF



Front extended terminal - F



EF terminal with cable lug



EF terminal with busbar

CB	Vers.	Busbars dimensions			Cable terminals		Tightening			H Terminal covers				H Separators			
		MAX [mm]			[mm]					[mm]				[mm]			
		W	D	Ø	W	Ø	Terminal/CB	Cable or busbar/terminal	2	50	60	68	25	100	200		
XT1	F	20	4	8.5	20	8.5	M6	6Nm	M8	9Nm	-	R	-	-	-	S _T	R
XT2	F	20	4	8.5	20	8.5	M6	6Nm	M8	9Nm	-	S _T	-	-	-	S _T	R
XT3	F	20	6	10	20	10	M8	8Nm	M10	18Nm	-	-	R	-	-	S _T	R
XT4	F	20	10	10	20	10	M8	8Nm	M10	18Nm	-	-	S _T	-	-	S _T	R
XT5	F	32.5	10	11	32.5	11	M10	28Nm	M10	18Nm	-	-	R	-	-	S _T	R
XT6 800	F	50	5	14	50	14	M6	9Nm	M12	30Nm	-	-	-	-	-	S _T	R
XT6 1000	F	50	6	14	50	14	M6	9Nm	M12	30Nm	-	-	-	-	-	S _T	R
XT7 - XT7 M	F	50	2x10	4x11	4x20	11	M10	18Nm	M10	40Nm	-	-	-	R	-	S _T	R

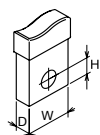

W Width

H Hole height

D Depth

F Fixed

P Plug-in

W Withdrawable

Ø Diameter

R On Request

S_{CB}

Supplied as standard with circuit-breaker, not available in the loose terminals kit

S_T

Supplied as standard with the terminals kit



Front extended spread terminal - F



ES terminal with cable lug



ES terminal with busbar



FCCu terminal



FCCu terminal with cable



FCCu terminal with busbar

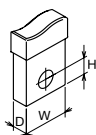

Front extended spread terminals - ES

CB	Vers.	Busbars dimensions MAX [mm]			Cable terminals [mm]		Tightening				H Terminal covers for extended spread terminals			H Separators [mm]		
		W	D	Ø	W	Ø	Terminal/CB	Cable or busbar/terminal			25	100	200			
XT1	F-P	25	4	8.5	25	8.5	M6	6Nm	M8	9Nm	-	-	-	S _T		
XT2	F-P-W	30	4	10.5	30	10.5	M6	6Nm	M10	18Nm	-	-	-	S _T		
XT3	F-P	30	4	10.5	30	10.5	M8	8Nm	M10	18Nm	-	-	-	S _T		
XT4	F-P-W	30	6	10.5	30	10.5	M8	8Nm	M10	18Nm	-	-	-	S _T		
XT5	F-P-W	40	10	11	40	11	M10	28Nm	M10	18Nm	R	-	-	S _T		
XT6	F-W	80	5	3x13	3x45	13	M6	9Nm	M12	30Nm	R	-	-	S _T		
XT7 - XT7 M	F	80	2x10	3x13	4x45	13	M10	18Nm	M12	40Nm	R	-	-	S _T		

Terminals for copper cables - FCCu

CB	Type of terminal	Vers.	Cable terminals [mm]		Tightening		L cable stripping covers [mm]			H Terminal covers [mm]			H Separators [mm]		
			Rigid	Flexible	Cable or busbar/terminal		2	50	60	25	100	200			
XT1	Internal	F-P	1x2.5...70	1x2.5...50	12x12mm	7Nm	12	-	R	-	S _{CB}	R			
	Internal	F-P	-	2x2.5...35				-	R	-	S _{CB}	R			
XT2	Internal	F-P-W	1x2.5...95	1x2.5...70	14x14mm	7Nm	14	-	R	-	S _{CB}	R			
	Internal	F-P-W	-	2x2.5...50				-	R	-	S _{CB}	R			
XT3	Internal	F-P	1x6...185	1x6...150	20x18mm	14Nm	20	-	-	R	S _{CB}	R			
	Internal	F-P	-	2x6...70				-	-	R	S _{CB}	R			
XT4	Internal	F-P-W	1x6...185	1x6...150	20x18mm	14Nm	20	-	-	R	S _{CB}	R			
	Internal	F-P-W	-	2x6...70				-	-	R	S _{CB}	R			

W Width P Plug-in S_{CB} Supplied as standard with circuit-breaker, not available in the loose terminals kit
 H Hole height W Withdrawable S_T Supplied as standard with the terminals kit
 D Depth Ø Diameter
 F Fixed R On Request

Power connection



Internal FCCuAl terminal for copper/aluminum cables



Internal FCCuAl terminal for copper and aluminum cable with take-up of auxiliary voltage



FCCuAl external terminal with cable



FCCuAl internal terminal with cable



FCCuAl external terminal with cables



Pitch adapter

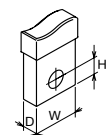

Terminals for copper/aluminium cables - FC CuAl

CB	Type of terminal	Vers.	Cable terminals [mm]		Tightening		L cable stripping covers [mm]	H Terminal covers [mm]				H Separators [mm]					
			Rigid	Flexible	Terminal/ CB	Cable or busbar/ terminal		2	50	60	68	25	100	200			
XT1	internal	F-P	1x1.5...70	1x1.5...50	M5	3Nm	Ø 9.5mm	≤10mm ² 2,5 Nm >10mm ² 5 Nm	16	-	R	-	-	S _{CB}	R	R	
	external	F-P	1x35...95	NO	M6	6Nm	Ø 14mm	13.5Nm	16	-	S _T	-	-	-	-	-	
	external	F-P ⁽²⁾	1x120...240	NO	M6	6Nm	Ø 24mm	31Nm	24	ADAPTER							
XT2	internal	F-P-W	1x1...95	1x2.5...70	-	-	Ø 14mm	≤ 25mm ² 4 Nm >25mm ² 6 Nm	14	-	R	-	-	S _{CB}	R	R	
	external	F-P-W ⁽²⁾	1x120...240	NO	M6	6Nm	Ø 24mm	31Nm	24	ADAPTER							
	external	F-P-W	1x70...185	NO	M6	6Nm	Ø 18mm	31Nm	20	-	S _T	-	-	-	-	-	
	external	F-P-W	2x35...70	NO	M6	6Nm	Ø 16mm	12Nm	18/33	-	-	S _T	-	-	-	-	
XT3	internal	F-P	1x35...150	NO	M9	9Nm	Ø 17mm	22.6Nm	20	-	-	R	-	S _{CB}	R	R	
	internal	F-P	1x95...185	NO	-	-	Ø 17mm	16Nm	20	-	-	R	-	S _{CB}	R	R	
	external	F-P ⁽²⁾	1x120...240	NO	M8	8Nm	Ø 24mm	31Nm	24	ADAPTER							
XT4	external	F-P	2x35...120	NO	M8	8Nm	Ø 18mm	16Nm	22/24	-	-	S _T	-	-	-	-	
	XT4	internal	F-P-W	1x1...150	NO	-	-	Ø 17mm	10Nm	20	-	-	R	-	S _{CB}	R	R
	external	F-P-W ⁽²⁾	1x120...240	NO	M8	8Nm	Ø 24mm	31Nm	24	ADAPTER							
XT5	external	F-P-W	2x35...120	NO	M8	8Nm	Ø 15mm	16Nm	22/24	-	-	S _T	-	-	-	-	
	XT5	internal	F-P-W	1x35...185	NO	M10	28Nm	Ø 17mm	24-35Nm	24	R	-	R	-	S _{CB}	R	R
	internal	F-P-W	1x120...240	NO	M10	28Nm	Ø 21,5mm	43Nm	24	R	-	R	-	S _{CB}	R	R	
	internal	F-P-W	1x185...300	NO	M10	28Nm	Ø 24,5mm	43Nm	24	R	-	R	-	S _{CB}	R	R	
XT6	external	F-P-W	2x70...240	NO	M10	28Nm	Ø 24mm	31Nm	24/46	-	-	R	-	S	R		
	XT6	internal ⁽¹⁾ F-W	2x120...240	NO	M6	5Nm	Ø 21.5mm	31Nm	-	-	-	S _T	-	-	-	-	
	external ⁽¹⁾ F-W	3x70...185	NO	M6	9Nm	Ø 19mm	43Nm	-	-	-	S _T	-	-	-	-	-	
XT7 - XT7 M	external	F-W	4x70...150	NO	M6	9Nm	Ø 19mm	43Nm	-	-	-	S _T	-	-	-	-	
	XT7 - XT7 M	internal	F (630A) 2x185...240	NO	M10	18Nm	Ø 21.5mm	43Nm	30	S _T	-	-	R	-	S _T	R	
XT7 M	external	F (1250A) 4x70...240	NO	M10	18Nm	Ø 21.5mm	43Nm	30	-	-	-	S _T	-	-	-	-	
	external	F (1600A) 3x240...380	NO	M10	18Nm	Ø 21.5mm	67Nm	30	-	-	-	S _T	-	-	-	-	

(1) Not available for XT6 1000A

(2) Not installable on circuit-breakers mounted on DIN rail or on rear mechanical interlock

Adapter for FCCuAl terminals up to 240mm²

Circuit-breaker	Poles	Dimensions [mm] [WxHxD]
XT1	3	105x50x68
	4	140x50x68
XT2	3	105x50x68
	4	140x50x68
XT3	3	105x50x68
	4	140x50x68
XT4	3	105x50x68
	4	140x50x68

With the XT1 and XT2 the adapter increases the width of the circuit-breaker

- W Width
- H Hole height
- D Depth
- F Fixed
- P Plug-in
- W Withdrawable
- Ø Diameter
- R On Request
- S_{CB} Supplied as standard with circuit-breaker, not available in the loose terminals kit
- S_T Supplied as standard with the terminals kit



Terminal for flexible busbars (FB)



FB terminal with flexible busbars



Multi-cable terminals (MC)



Multi-cable terminals with cables



Rear horizontal terminals (R)



R terminal with horizontal busbar



R terminal with vertical busbar

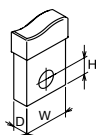

Terminals for flexible busbars - FB

CB	Type of terminal	Vers.	Busbar dimensions MIN [mm]			Busbar dimensions MAX [mm]			Tightening [Nm]	H Terminal covers [mm]			H Separators [mm]		
			W	D	Nr	W	D	Nr		2	50	60	25	100	200
XT1	internal	F-P	10	0.8	2	10	0.8	9	7Nm	-	R	-	S _{CB}	R	R
XT2	internal	F-P-W	10	0.8	2	10	0.8	9	7Nm	-	R	-	S _{CB}	R	R
XT3	internal	F-P	16	0.8	2	16	0.8	10	14Nm	-	-	R	S _{CB}	R	R
XT4	internal	F-P-W	16	0.8	2	16	0.8	10	14Nm	-	-	R	S _{CB}	R	R

Multi-cable terminals - MC

CB	Vers.	Cable [mm ²]		Tightening			L cable stripping [mm]	H Terminal covers [mm]			H Separators [mm]				
		Rigid	Flexible	Terminal/ CB	Cable or busbar/ terminal	Terminal /CB		Cable or busbar/ terminal	2	50	60	25	100	200	
XT1	F-P	6x2.5...35	6x2.5...35	M6	6Nm	Ø 8	≤10mm ² 2.5 Nm >10mm ² 4 Nm	10, 20, 30	-	S _T	-	-	-	-	-
XT2	F-P-W	6x2.5...35	6x2.5...35	M6	6Nm	Ø 8	≤10mm ² 2.5 Nm >10mm ² 4 Nm	10, 20, 30	-	S _T	-	-	-	-	-
XT3 ⁽¹⁾	F-P	6x2.5...35	6x2.5...25	M8	8Nm	Ø 8	7Nm	15, 30	-	-	S _T	-	-	-	-
XT4 ⁽¹⁾	F-P-W	6x2.5...35	6x2.5...25	M8	8Nm	Ø 8	7Nm	15, 30	-	-	S _T	-	-	-	-

(1) Take up auxiliary voltage device included

Rear horizontal terminals - R

CB	Vers.	Busbar dimensions MAX [mm]				Tightening			H Terminal covers [mm]			H Separators [mm]			
		W	H	D	Ø	Terminal /CB	Cable or busbar/ terminal	Terminal /CB	Cable or busbar/ terminal	2	50	60	25	100	200
XT1	F	15	7.5	5	6.5	M5	5Nm	M6	6Nm	S _T	-	-	-	-	-
XT2	F	20	9	4	8.5	M6	6Nm	M8	6Nm	S _T	-	-	-	-	-
XT3	F	20	9	6	8.5	M8	8Nm	M8	8Nm	S _T	-	-	-	-	-
XT4	F	20	9	6	8.5	M8	8Nm	M8	8Nm	S _T	-	-	-	-	-
XT5	F	30	20	10	11	M10	28Nm	M10	18Nm	S _T	-	-	-	-	-
XT6	F	50	-	5	14	M6	18Nm	M12	30Nm	S _T	-	-	-	-	-

W Width P Plug-in S_{CB} Supplied as standard with circuit-breaker, not available in the loose terminals kit
 H Hole height W Withdrawable S_T Supplied as standard with the terminals kit
 D Depth Ø Diameter
 F Fixed R On Request

Power connection

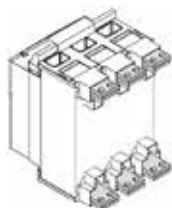

Rear orientable terminal - HR VR

Rear horizontal terminals - R

CB	Vers.	Busbar dimensions MAX [mm]				Tightening				H Terminal covers [mm]			H Separators [mm]		
		W	H	D	Ø	Terminal/CB	Cable or busbar/ terminal		2	-	68	25	100	200	
XT7 - XT7 M	F	50	14	2x10	2x11	M10	20Nm	M10	40Nm	S _T	-	-	-	-	-

Terminals for fixed part

Extended front terminals for fixed part - EF

CB	Vers.	Busbar dimensions MAX [mm]			Cable terminals [mm]		Tightening				Rear Separators [mm]		
		W	D	Ø	W	Ø	Terminal/CB	Cable or busbar/ Terminal		25	100	200	
XT1	P	20	5	6.5	21	6.5	M6	6Nm	M6	9Nm	-	S _T	R
XT2	P-W	20	5	6.5	21	6.5	M6	6Nm	M6	9Nm	-	S _T	R
XT3	P	25	8	8.5	30	8.5	M6	6Nm	M8	18Nm	-	S _T	R
XT4	P-W	25	8	8.5	30	8.5	M6	6Nm	M8	18Nm	-	S _T	R
XT5	P-W	30	15	10	30	10	-	-	M10	18Nm	-	S _T	R
XT6	W	50	5	14	50	14	-	9Nm	M14	30Nm	-	-	-
XT7 - XT7 M	W	50	2x10	11	4x20	11	M6	12	M10	40Nm	-	-	-



EF terminals for fixed part

Rear flat horizontal terminals for fixed part - HR

CB	Vers.	Busbar dimensions MAX [mm]			Cable terminals [mm]		Tightening			Rear Separators [mm]		
		W	D	Ø	W	Ø	Terminal/CB	Cable or busbar/ Terminal		90	-	-
XT1	P	20	4	8.5	20	8.5	6Nm	-	9Nm	-	-	R
XT2	P-W	20	4	8.5	20	8.5	6Nm	-	9Nm	-	-	R
XT3	P	25	6	8.5	25	8.5	6Nm	-	9Nm	-	-	R
XT4	P-W	25	10	8.5	25	8.5	6Nm	-	9Nm	-	-	R
XT5 400A	P-W	25	5	11	25	11	-	-	18Nm	-	-	R
XT5 630A	P-W	40	8	11	40	11	-	-	18Nm	-	-	R
XT6	W	50	5	14	50	14	-	-	30Nm	-	-	-
XT7 - XT7 M	W	50	2x10	2x11	4x20	11	12Nm	-	40Nm	-	-	-



HR terminals for fixed part XT1...XT4

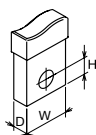

W	Width	P	Plug-in	S _{CB}	Supplied as standard with circuit-breaker, not available in the loose terminals kit
H	Hole height	W	Withdrawable	S _T	Supplied as standard with the terminals kit
D	Depth	Ø	Diameter		
F	Fixed	R	On Request		



VR terminals for fixed part XT1...XT4

Rear flat vertical terminals for fixed part - VR

CB	Vers.	Busbar dimensions MAX [mm]			Cable terminals [mm]		Tightening		Rear Separators [mm]	
		W	D	Ø	W	Ø	Terminal/CB	Cable or busbar/ Terminal	90	
XT1	P	20	4	8.5	20	8.5	6Nm	9Nm	R	
XT2	P-W	20	4	8.5	20	8.5	6Nm	9Nm	R	
XT3	P	25	6	8.5	25	8.5	6Nm	9Nm	R	
XT4	P-W	25	10	8.5	25	8.5	6Nm	9Nm	R	
XT5 400A	P-W	25	5	11	25	11	-	18Nm	R	
XT5 630A	P-W	40	8	11	40	11	-	18Nm	R	
XT6	W	50	5	14	50	14	-	30Nm	-	
XT7 - XT7 M	W	50	2x10	2x11	4x20	11	12Nm	40Nm	-	

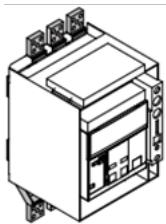

Extended front terminal - HR VR

Front extended spread terminals for fixed part - ES

CB	Vers.	Busbar dimensions MAX [mm]			Cable terminals [mm]		Tightening		H Terminal covers [mm]		H Separators [mm]			
		W	D	Ø	W	Ø	Terminal /CB	Cable or busbar/ terminal	-	-	68	-	100	200
XT7 - XT7 M	W	80	2x10	3x13	4x45	13	M6 12Nm	M12 40Nm	-	-	-	-	R	R

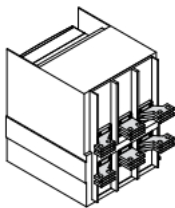

Horizontal rear terminals -SHR

Horizontal rear spread terminals for fixed part -SHR

CB	Vers.	Busbar dimensions MAX [mm]			Cable terminals [mm]		Tightening		Cable or busbar/ Terminal	
		W	D	Ø	W	Ø	Terminal/CB	Cable or busbar/ Terminal		
XT7 - XT7 M	W	60	2x10	2x11	4x30	11	M10 40Nm	M10 40Nm		

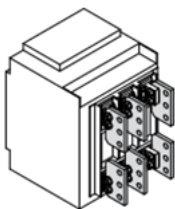

Terminal for cable FcCuAl 4x240mm² - FCCuAl

Front copper/aluminium cables for fixed part - FCCuAl

CB	Type of terminal	Vers.	Cable terminals [mm]		Tightening		Cable or busbar/terminal	
			Rigid	Flexible	Terminal/CB	Cable or busbar/terminal		
XT7 - XT7 M		W	6x25 4x35	6x25 4x35	M10	48Nm	M12 M14	70Nm

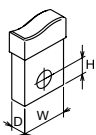

W Width P Plug-in S_{CB} Supplied as standard with circuit-breaker, not available in the loose terminals kit
 H Hole height W Withdrawable S_T Supplied as standard with the terminals kit
 D Depth Ø Diameter
 F Fixed R On Request

Auxiliary contacts - AUX

The SACE Tmax XT circuit-breakers can be equipped with auxiliary contacts that signal the status of the breaker and can be routed outside the circuit-breaker itself. The following information is available:

- **open/closed (Q):** indication of the status of the circuit-breaker power contacts;
- **trip (SY):** signals that the circuit-breaker is opening due to the intervention of the trip unit, or to the intervention residual current device, or to the opening of undervoltage releases, or to the use of the emergency opening pushbutton of the motor operator, or to the use of the test button;
- **trip unit tripping (S51):** indicates that one of the protection functions of the electronic or thermal-magnetic trip unit has tripped. In case of the Tmax XT5 equipped with thermal-magnetic trip unit and residual current device, S51 is activated also by the intervention of the residual current device.
- **YO/YU tripping (S52):** indicates that the under voltage or shunt opening release has been activated. The signaling depends on the service release used. For Tmax XT6 S52 can be used only with YU and is not available for YO. For Tmax XT5, in case of YO, shunt opening release must be permanently supplied to maintain the S52 signal.

AUX for XT1, XT2, XT3, XT4, XT5 and XT6

Circuit -breakers	XT1-XT3		XT2-XT4		XT5			XT6					
AUX	Q	SY	Q	SY	S51	Q	SY	S51	S52	Q	SY	S51	S52
24V DC	■	■	■	■	■	■	■	■	■	■	■	■	■
250V AC/DC	■	■	■	■	■	■	■	■	■	■	■	■	■
400V AC	-	-	■	■	-	■	■	-	-	-	-	-	-

24V DC and 250V AC/DC auxiliary contacts

Auxiliary contacts Q (open/closed), SY (trip), S51 (trip unit tripping) and S52 (YO/YU tripping) status during sequences

Actions	Q	SY	S51	S52
Normal Sequence				
CB Opened	12	96	06	26
CB Closed	14	96	06	26
Trip sequence (caused by: Trip Test)				
CB Opened	12	96	06	26
CB Closed	14	96	06	26
CB Tripped	12	98	06	26
CB Reset	12	96	06	26
Trip sequence (caused by: trip unit)				
CB Opened	12	96	06	26
CB Closed	14	96	06	26
CB Tripped	12	98	08	26
CB Reset	12	96	06	26
Trip sequence (caused by: YU / YO)				
CB Opened	12	96	06	26
CB Closed	14	96	06	26
CB Tripped	12	98	06	28
CB Reset	12	96	06	26

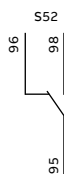
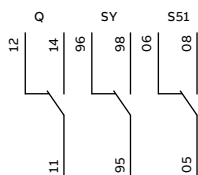

Signaling



Cabled auxiliary contact



Uncabled auxiliary contact



Cabled auxiliary contact for withdrawable circuit-breaker

250V AC/DC and 24V AC/DC auxiliary contacts are installed without the need for any screws. They are extremely easy to fit. Simply apply a slight pressure in the appropriate place. The following versions of auxiliary contacts are available:

- cabled (AWG20 cable section -0.5mm²):
 - for fixed/plug-in circuit-breakers with 1m long cables;
 - for withdrawable circuit-breakers with fixed part and moving part connector;
- not cabled:
 - for fixed/plug-in circuit-breakers with cables from 0.5 up to 1.5 mm² cross-section.

Auxiliary contacts are supplied for each circuit-breaker in the SACE XT family in various different combinations, as shown in the table. The following items can be ordered to make the installation even more flexible:

- an uncabled auxiliary contact can generate different signals (Q, SY or S52) according to the position that the circuit-breaker is installed at;
- an uncabled S51 auxiliary contact, which can be used for XT2, XT4, XT5 and XT6 circuit-breakers;
- a cabled auxiliary contact, with unnumbered cables. It can generate different signals (Q, SY or S52) according to the position where the circuit-breaker is installed.

Combinations of cabled auxiliary contacts with numbered cables	XT1	XT2	XT3	XT4
	3/4p	3/4p	3/4p	3/4p
1Q 1SY 24V DC	F-P	F-P-W	F-P	F-P-W
3Q 1SY 24V DC	-	F-P-W	F-P	F-P-W
1S51 24V DC	-	F-P-W	-	F-P-W
1Q 1SY 250V AC/DC	F-P	F-P-W	F-P	F-P-W
2Q 2SY 1S51 250V AC/DC	-	F-P-W	-	F-P-W
3Q 2SY 250V AC/DC	-	F-P-W	-	F-P-W
3Q 1SY 250V AC/DC	-	F-P-W	F-P	F-P-W
1S51 250V AC/DC	-	F-P-W	-	F-P-W
2Q 1SY 250V AC/DC	F-P	F-P	F-P	F-P
3Q on the left 250V AC/DC	F-P	F-P	F-P	F-P

F = Fixed, P = Plug-in, W = Withdrawable

Combinations of cabled auxiliary contacts with numbered cables	XT5	XT6
	Thermal-magnetic and Ekip Dip trip unit	Ekip Touch and Hi-Touch trip unit
1Q + 1SY on the left 24V DC	F-P	-
1Q + 1SY 24V DC	F-P-W	F-P-W
3Q + 1SY 24V DC	F-P-W	F-P-W
1S51 24V DC	F-P-W	F-P-W
1S52 24V DC	F-P-W	F-P-W
1Q + 1SY on the left 250V AC/DC	F-P	-
1Q + 1SY 250V AC/DC	F-P-W	F-P-W
2Q + 1SY 250V AC/DC	F-P-W	F-P-W
3Q + 1SY 250V DC	F-P-W	F-P-W
1S51 250V AC/DC	F-P-W	F-P-W
1S52 250V AC/DC	F-P-W	F-P-W

F = Fixed, P = Plug-in, W = Withdrawable

Auxiliary contacts 24V DC - 250V AC/DC

	3-pole circuit-breaker	4-pole circuit-breaker
XT1	<p>2Q 1SY 3Q left</p>	<p>2Q 1SY 3Q left</p>
XT3	<p>3Q 1SY 3Q left</p>	<p>3Q 1SY 3Q left</p>
XT2 XT4	<p>2SY 2Q 1S51 or 1Q 3Q left</p>	<p>2SY 2Q 1S51 or 1Q 3Q left</p>
XT2 XT4 with Ekip Touch and Hi-Touch trip units	<p>3Q left</p>	<p>3Q left</p>
XT5	<p>1SY 1Q+ 1SY left 3Q 1S51 1S52</p>	<p>1SY 1Q+ 1SY left 3Q 1S51 1S52</p>
XT5 with Ekip Touch and Hi-Touch trip units	<p>1SY 1S52 3Q 1S51</p>	<p>1SY 1S52 3Q 1S51</p>
XT6	<p>1SY 1S52 3Q 1S51</p>	<p>1SY 1S52 3Q 1S51</p>

Signaling

AUX 250V AC/DC - Electrical specifications

Power supply voltage	Operating current according to the utilization category					
	AC-15	AC-14	AC-13	DC-14	DC-13	DC-12
250V AC	4 A	5 A	6 A	-	-	-
125V AC	5 A	6 A	6 A	-	-	-
250V DC	-	-	-	0.03 A	0.03 A	0.3 A
110V DC	-	-	-	0.05 A	0.05 A	0.5 A

AUX 24V DC - Electrical specifications

Power supply voltage	Operating current
5 V DC	0.001 A
30 V DC	0.1 A

400V AC auxiliary contacts

400V AC auxiliary contacts are available only for the XT2, XT4 and XT5 circuit-breakers in the following versions:

- cabled (AWG17 cable section -1mm²):
 - for fixed/plug-in circuit-breakers with 1m long cables;
 - for withdrawable circuit-breakers with a fixed part and moving part connector.

With the XT2 and XT4, the 400V auxiliary contacts take up the whole right-hand slot of the circuit-breaker. For the XT5 1Q+1SY, the 400V auxiliary contacts are available only with thermal-magnetic or Ekip Dip trip units.



Cabled auxiliary contact

Combinations	XT2	XT4	XT5
	3/4p	3/4p	3/4p
1Q 1SY 400V	F-P-W	F-P-W	F-P-W ⁽¹⁾
2Q 400V	F-P-W	F-P-W	F-P-W

F = Fixed, P = Plug-in, W = Withdrawable

(1) Only for circuit-breakers with thermal-magnetic or Ekip Dip trip units.

400V AC auxiliary contacts



(1) Not available with Ekip Touch and Hi-Touch trip units

AUX 400V AC - Electrical specifications

Power supply voltage [V]	Operating current [A]	
	AC	DC
125 AC/DC	-	0.5
250 AC/DC	12	0.3
400 AC ⁽¹⁾	3	-

(1) Only ENEC approved

Signaling

AUX for XT7 and XT7 M

Circuit -breakers	XT7				XT7 M		
AUX	Q	SY	S51	S52	Q	S51	RTC
24V DC	■	■	■	■	■	■	■
250V AC/DC	■ ⁽¹⁾	■ ⁽¹⁾	■	■	■ ⁽¹⁾	■	■
400V AC	■	■	-	-	■	-	-

(1) Same commercial code of AUX 400V

Open / closed auxiliary contacts - Q

The XT7 and XT7 M circuit-breakers can be equipped with auxiliary contacts that signal the open or closed status of the circuit-breaker. The contacts are available in the following configurations:

Open / closed auxiliary contacts (AUX 4Q)		XT7	XT7 M
4 auxiliary contacts	4Q 400V AC/DC	■	■
	4Q 24V DC	■	■
	2Q 400V AC/DC + 2Q 24V DC	■	■
15 auxiliary contacts	15Q 400V AC/DC		■
	15Q 24V DC		■

	400V/250V AC/DC contact	24V DC contact
Type	Changeover contacts	Changeover contacts
Minimum load	100mA @ 24V	1mA @ 5V
Breaking capacity		
DC	24V	-
	125V	0.3A @ 10ms
	250V	0.15A @ 10ms
AC	250V	5A @ cosφ 1
		5A @ cosφ 0.7
		5A @ cosφ 0.3
	400V	3A @ cosφ 1
		2A @ cosφ 0.7
		1A @ cosφ 0.3

The AUX 15Q is an alternative to the mechanical interlock (MI), the DLC for XT7 M lock or the DLP lock if mounted on the right side.

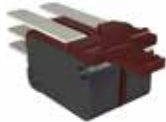

Open and close auxiliary contacts



15 auxiliary contacts

Trip auxiliary contact - SY

The XT7 circuit-breakers can be equipped with auxiliary contacts that signal that the circuit-breaker is opening due to the intervention of the trip unit, or to the opening of undervoltage/shunt opening releases, or to the use of the test button. The contacts are available in the following configurations:

		400V/250V AC/DC contact	24V DC contact
Type		Switching	Switching
Minimum load		100mA @ 24V	1mA @ 5V
Breaking capacity			
DC	24V	-	0.1A
	125V	0.3A	-
	250V	0.15A	-
AC	250V	12A	-
	400V	3A	-

Contact signaling the tripping of the protection unit Ekip – S51

This contact signals the opening of the circuit-breaker after the Ekip protection trip unit has tripped. The contact is available for the XT7 and XT7 M.

For the XT7 M circuit-breaker, the closing operation can be carried out only after the “TU Reset” push-button has been restored to its normal operating position. The switching contact can also be associated with an optional accessory for remote resetting - YR.



Contact signaling the tripping of the Ekip trip unit protection - S51

		250V AC/DC contact	24V DC contact
Type		Switching	Switching
Minimum load		100mA @ 24V	1mA @ 5V
Breaking capacity			
DC	24V	-	0.1A
	250V	0.5A @ 0ms / 0.2A @ 10ms	-
AC	250V	3A @ cosφ 0.7	-

Contact signaling tripping of the YO/YU – S52

This contact signals that the undervoltage (YU) or the shunt opening release (YO) have been activated. The contact is the same and depends on the service release mounted in the dedicated position.

It is available for the XT7 only.

		250V AC/DC contact	24V DC contact
Type		Switching	Switching
Minimum load		100mA @ 24V	1mA @ 5V
Breaking capacity			
DC	24V	-	0.1A
	250V	0.5A @ 0ms / 0.2A @ 10ms	-
AC	250V	3A @ cosφ 0.7	-

Signaling

Auxiliary Position Contacts – AUP

Auxiliary position contacts provide information about the position of the circuit-breaker in relation to the fixed part of plug-in or withdrawable versions.

Three types of position contacts (AUPs) are available:

- racked-in contact for all plug-in and withdrawable Tmax XT circuit-breakers;
- racked-out contact for all withdrawable Tmax XT circuit-breakers;
- test contact for withdrawable Tmax XT5, XT6, XT7 and XT7 M circuit-breakers.

Circuit-breaker		Max number of racked-in contacts	Max number of test contacts	Max number of racked-out contacts	Max number of AUP
XT1	3/4 poles	4	-	-	4
XT2	3 poles	2	-	2	4
	4 poles	4	-	2	6
XT3	3/4 poles	4	-	-	4
XT4	3/4 poles	4	-	2	6
XT5	3/4 poles	3	1	1	5
XT6	3/4 poles	3	1	1	5
XT7	3/4 poles	2	2	2	6
XT7 M	3/4 poles	2	2	2	6

Auxiliary position contacts, which provide electrical signaling of the circuit-breaker position in relation to the fixed part, are available in the following versions:

AUP	XT1	XT2	XT3	XT4	XT5	XT6	XT7	XT7 M
24V DC	■	■	■	■	■	■	■	■
250V AC/DC	■	■	■	■	■	■	■ ⁽¹⁾	■ ⁽¹⁾
400V AC	-	-	-	-	-	-	■	■

(1) Same commercial code of AUX 400V

AUP for XT1, XT2, XT3 and XT4



Auxiliary position contact

AUX 250V AC - Electrical specifications

Power supply voltage [V]	Operating current according to the utilization category					
	AC-15	AC-14	AC-13	DC-14	DC-13	DC-12
250V AC	4 A	5 A	6 A	-	-	-
125V AC	5 A	6 A	6 A	-	-	-
250V DC	-	-	-	0.03 A	0.03 A	0.3 A
110V DC	-	-	-	0.05 A	0.05 A	0.5 A

AUX 24V DC - Electrical specifications

Power supply voltage	Operating current
5V DC	0.001 A
24V DC	0.1 A

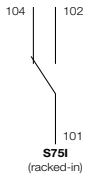

Plug-in circuit-breaker with racked-in contact



S75I=104

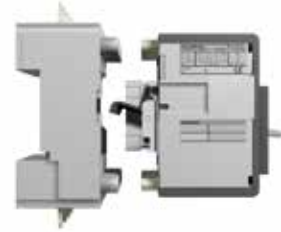

S75I=102



Withdrawable circuit-breaker with racked-in/racked-out contacts



S75I=102
S75E=144



S75I=102
S75E=142



S75I=104
S75E=142

Signaling



Auxiliary position contact

AUP for XT5 and XT6

AUX 25V AC/DC - Electrical specifications

Power supply voltage	Operating current according to class of use					
	AC-15	AC-14	AC-13	DC-14	DC-13	DC-12
250V AC	4A	5A	6A	-	-	-
125V AC	5A	6A	6A	-	-	-
250V DC	-	-	-	0.03A	-	0.3A
110V AC	-	-	-	0.05A	-	0.5A

AUX 25V DC - Electrical specifications

Power supply voltage	Operating current
5V DC	0.001A
24V DC	0.1A

AUP for XT7 and XT7 M

	400V/250V AC/DC contact	24V DC contact
Type	Changeover contacts	Changeover contacts
Minimum load	100mA @ 24V	1mA @ 5V
Breaking capacity		
DC	24V	-
	125V	0.3A @ 10ms
	250V	0.15A @ 10ms
AC	250V	5A @ cosφ 1
		5A @ cosφ 0.7
		5A @ cosφ 0.3
	400V	3A @ cosφ 1
		2A @ cosφ 0.7
		1A @ cosφ 0.3



Auxiliary position contacts - AUP



Early Auxiliary Contacts

Early Auxiliary Contacts – AUE

Early closing auxiliary contacts: these allow the undervoltage release to be supplied before the main contacts close, in accordance with IEC 60204-1 and VDE 0113 standards.

Early opening auxiliary contacts: these allow any electronic devices connected to the system to be disconnected in advance before the system is damaged by an overvoltage caused by the circuit-breaker opening.

The early opening/closing auxiliary contacts can be installed inside the direct and transmitted rotary handle operating mechanisms for all the SACE Tmax XT family circuit-breakers except for the XT7 (max two contacts @ 400V):

- the cabled version includes 1m long cables (AWG20 cable sections);
- a dedicated code is available in the withdrawable version which includes the connector for the moving and fixed parts;

For the XT7 with a lever operating mechanism, these are mounted directly on the circuit-breaker.

	XT1	XT2	XT3	XT4	XT5	XT6	XT7	XT7 M
AUE closing	■	■	■	■	■	■	■	-
AUE opening	■	■	■	■	-	-	-	-

Early Auxiliary Contacts – AUE for XT7

400V/250V AC/DC contact		
Type	Switching	
Minimum load	100mA @ 24V	
Breaking capacity		
DC	125V	0.3A
	250V	0.15A
AC	250V	12A
	400V ⁽¹⁾	3A

(1) Only ENEC approved

Ready to close signaling contact - RTC

The ready to close signaling contact – RTC – indicates that the circuit-breaker is ready to receive the closing command and is available only for the XT7 M. The circuit-breaker is ready to close when the following conditions are fulfilled:

- the circuit-breaker is open
- the springs are loaded
- there are no opening command or locks on the opening command
- the circuit-breaker is reset following tripping of the Ekip protection trip unit.



Ready to close signaling contact

		250V AC/DC contact	24V DC contact
Type	Switching		Switching
Minimum load	100mA @ 24V		1mA @ 5V
Breaking capacity			
DC	24V	-	0.1A
	250V	0.5A @ 0ms / 0.2A @ 10ms	-
AC	250V	3A @ cosφ 0.7	-

Contact signaling loaded springs - S33 M/2

This contact is available for XT7 M only and signals the spring status of the circuit-breaker operating mechanism. It is available in both 400V AC/DC and 24V DC versions.

		400V AC/DC contact	24V DC contact
Type	Changeover contacts		Changeover contacts
Minimum load	100mA @ 24V		1mA @ 5V
Breaking capacity			
DC	24V	-	0.1A
	125V	0.3A @ 10ms	-
	250V	0.15A @ 10ms	-
AC	250V	5A @ cosφ 1	-
		5A @ cosφ 0.7	-
		5A @ cosφ 0.3	-
	400V	3A @ cosφ 1	-
		2A @ cosφ 0.7	-
		1A @ cosφ 0.3	-

Mechanical signaling of tripping the protection trip unit - TU Reset

XT7 M circuit-breakers are always equipped with a mechanical device that signals the tripping status of the protection trip units. After the Ekip trip unit has been tripped due to an electrical fault, the signaling device clearly indicates the tripping status on the front of the circuit-breaker. The circuit-breaker can be reset only after the signaling pushbutton has been restored to its normal operating position.



TU Reset

Operating mechanism

Operating mechanism		XT1	XT2	XT3	XT4	XT5	XT6	XT7	XT7 M
Rotary handle operating mechanism	RHD - Direct rotary handle	■	■	■	■	■	■	■	-
	RHE - Transmitted rotary handle	■	■	■	■	■	■	■	-
	RHE_LH - Wide transmitted rotary handle	■	■	■	■	-	-	-	-
	RHS - Side rotary handle	■	■	■	■	■	-	-	-
	Conversion kit for telescopic rod	-	-	-	■	■	■	■	-
Front lever op. mech.	FLD - Front for locks	-	■	-	■	■	■	-	-
Toggle extension	Toggle extension for operating circuit-breaker	-	-	-	-	■	■	■	-

Rotary handle operating mechanism

This is an operating device that allows the circuit-breaker to be operated by means of a rotary handle, which makes the circuit-breaker easier to open and close thanks to its ergonomic handgrip.

Different types of handles are available:

- direct (RHD): installed on the panel door for frontal operation;
- transmitted (RHE): installed on the panel door. It allows the circuit-breaker to be operated by means of a rod which acts on a base installed on the front of the circuit-breaker;
- lateral (RHS): installed directly on the front of the circuit-breaker for side operations.

For the XT1, XT2, XT3 and XT4 a large handle grip (LH) is also available, which can be combined with the transmitted handle (RHE) and with the lateral handle (RHS).

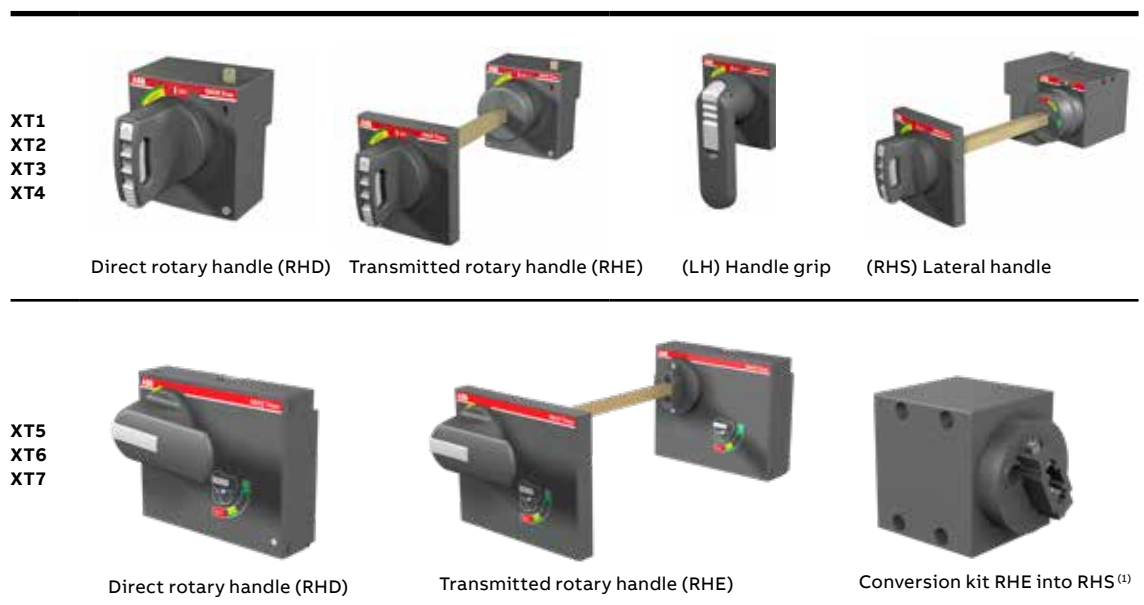

(1) Available for XT5 only

All rotary handles are available in two versions:

- standard: grey color;
- emergency color: red on a yellow background. Suitable for operating machine tools.

Transmitted rotary handles can be ordered in the following ways:

- by one single commercial code (for RHD, RHE, RHS L/R);
- by listing the commercial codes of the following three components (for RHE only):
 - the base of the rotary handle to be fixed onto the circuit-breaker (RHE_B);
 - a 500mm transmission rod (RHE_S). The minimum and maximum distances between the fixing plate and the door are 60.5mm and 470.5mm respectively;
 - a rotary handle on the compartment door with a normal standard handgrip (RHE_H, RHE_H LH) or emergency handgrip (RHE_H_EM, RHE_H_EM LH).

To install the lateral rotary handle (RHS) on the XT5, the transmitted rotary handle (RHE code) and the conversion kit (from RHE to RHS) must be ordered.

The use of the rotary handle is an alternative to the motor operator and to all accessories mounted on the front of the circuit-breaker.

The rotary handles can be locked by means of a wide range of key locks and padlocks (see the Chapter "Safety and Protection" - section on "Locks").

The direct and transmitted rotary handle operating mechanisms allow early closing auxiliary contacts to be used when closing to supply the undervoltage release before the circuit-breaker closes.

For the XT5, XT6 and XT7 there is a special version of the RHD and RHE with an additional padlock (2PLL). For XT1 and XT4 there is a special version of RHE with an additional padlock on the base (2PLL).

Fig. 1
RHD XT5 additional padlock



Fig. 2
RHE XT5 additional padlock



Fig. 3
RHD XT7 additional padlock

Fig. 1

Fig. 3

Fig. 4
RHE XT7 additional padlock



Fig. 2



Fig. 4

Conversion kit for telescopic rod

This device must be installed on the rod of the extended rotary handle (RHE) and allows the panel door to be closed even with the withdrawable circuit-breaker in the racked-out position.

Operating mechanism



Flange handle

Flange handle

Installed on the panel door. It allows fixed circuit breakers to be operated in accordance with NFPA and UL508A Standards by means of cables of different length (4',6',10'), which act on a base installed on the front of the circuit breaker. Two different versions of handles are available in order to fully meet the Standard prescriptions required by the application: NEMA 1, 3, 12, 4 metallic and NEMA 1, 3, 12, 4, 4X non-metallic.



NFPA handle

NFPA handle

Thanks to this handle mounted on the shaft of the RHE mechanism, the operator is allowed to operate the circuit breaker and to lock it in OFF position by means of an embedded padlock device also in case of panel door open, as prescribed by the Standards NFPA 79 and UL508A.



Front for the operating lever mechanism

Front for the lever operating mechanism

This device can be installed on the front of the circuit-breaker and for withdrawable circuit-breakers inside switchboards, it allows the IP40 degree of protection to be maintained for the whole insulation run of the circuit-breaker.

It is always fitted with a compartment door lock and with a slot for a padlock device in the open position (6 mm Ø stem up to three padlocks - not supplied) which prevents closing the circuit-breaker and the compartment door.

The front for the lever operating mechanism can only be installed on the XT2, XT4, XT5 and XT6 circuit-breakers. The front for the lever operating mechanism can be fitted with a wide range of key locks and padlocks (see the Chapter "Safety and Protection" - section "Locks").

The use of the front for the lever operating mechanism is an alternative to the motor operator and to all of the front type accessories.

Toggle extension

This device can be used to easily operate the toggle of the circuit-breaker, during manual closing and opening operations.

The device is removable and does not need screws in order to mount and operate it.

Remote control

Remote control		XT1	XT2	XT3	XT4	XT5	XT6	XT7	XT7 M
Service release	SOR - Shunt opening release	■	■	■	■	-	-	-	-
	UVR - Undervoltage release	■	■	■	■	-	-	-	-
	YO - Shunt opening release	-	-	-	-	■	■	■	■
	YU - Undervoltage release	-	-	-	-	■	■	■	■
	YC - Shunt closing release	-	-	-	-	-	-	-	■
Remote reset	YR - Resetting remotely	-	-	-	-	-	-	-	■
YO/YU Test Unit	YO/YC Test Unit	■	■	■	■	■	■	■	■
Time delay device for YU	UVD - Time delay device for YU	■	■	■	■	■	■	■	■
Motor operator	MOD	■	-	■	-	-	-	-	-
	MOE	-	■	-	■	■	■	-	-
	MOE-E	-	■	-	■	■	-	-	-
	M - Motor	-	-	-	-	-	-	-	■

Service releases

The SACE Tmax XT circuit-breakers can be fitted with service releases (shunt opening release, shunt closing release for XT7M only and undervoltage release).

XT1, XT2, XT3 and XT4

Shunt opening release – SOR

This allows the circuit-breaker to open by means of a non-permanent electrical control. Release operation is guaranteed for voltage between 70% and 110% of the rated power supply voltage U_n , in both alternating and direct current. The SOR is equipped with a built-in limit contact to shut-off the power supply in the open position with the trip unit tripped.

A remote-controlled emergency opening command can be generated by connecting an opening button to the SOR.



Cabled SOR - UVR



Cabled SOR - UVR for withdrawable circuit-breaker



Uncabled SOR - UVR

Undervoltage release – UVR

This allows the circuit-breaker to open when the release is subject either to a power failure or a voltage drop. As prescribed in the standards, opening is guaranteed when the voltage is between 70% to 35% U_n . After tripping, the circuit-breaker can be closed again if the voltage exceeds the 85% U_n . When the undervoltage release is not energized, neither the circuit-breaker or the main contacts can be closed. A remote-controlled emergency opening command can be generated by connecting an opening button to the UVR.

None of the service releases require screws for installation. They are extremely easy to fit. Just use slight pressure in the appropriate place. All service releases are available in two versions:

- cabled (AWG20 cable section - 0.5mm² up to 300V, AWG17 - 1mm² up to 525V):
 - for fixed/plug-in circuit-breakers with 1m long cables;
 - for withdrawable circuit-breakers with a fixed and moving part connector;
- not cabled:
 - for fixed/plug-in circuit-breakers with cables from 1.5 mm² in cross-section.

Remote control

Installation in circuit-breakers:

- 3-pole: as an alternative, the SOR or UVR can be installed in the slot on the left of the operating lever;
- 4-pole: the SOR or UVR can be housed at the same time in the slot of the third and fourth pole. For withdrawable circuit-breakers, the connector for the fourth pole must be ordered to be able to install the SOR and UVR in the fourth pole. If there is a residual current release, the opening solenoid (RC Coil) of the residual current device must be installed in the slot of the third pole on the left of the operating lever.

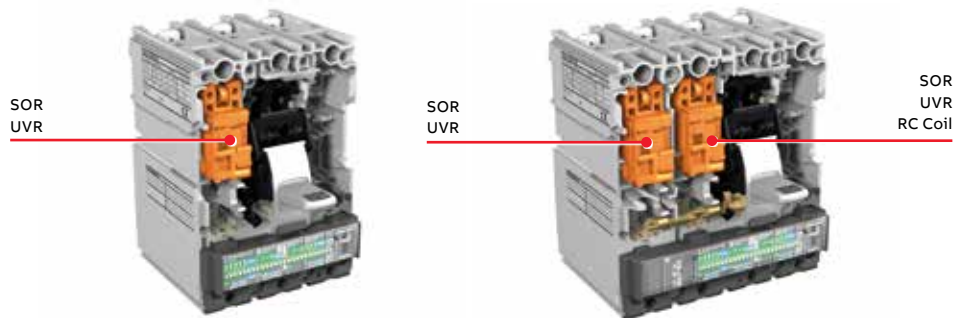

SOR Electrical specifications

Version	Max power absorbed on inrush		Resistance	
	AC [VA]	DC [W]	Internal [ohm]	External [ohm]
12V DC		50	2.67	0
24-30V AC/DC	50	50	11	0
48-60V AC/DC	60	60	62	0
110...127V AC-110...125V DC	50	50	248	0
220...240V AC-220...250V DC	50	50	930	0
380-440V AC	55		2300	0
480-525V AC	55		5830	0

UVR Electrical specification

Version	Power absorbed during normal operation		Resistance	
	AC [VA]	DC [W]	Internal [ohm]	External [ohm]
24-30V AC/DC	1.5	1.5	399	0
48V AC/DC	1	1	1447	100
60V AC/DC	1	1	2405	100
110...127V AC-110...125V DC	2	2	8351	390
220...240V AC-220...250V DC	2.5	2.5	20502	9000
380-440V AC	3		20502	39000
480-525V AC	4		20502	59000

XT5 and XT6

Shunt opening release – YO

This allows the circuit-breaker to open by means of a permanent electrical control. Release operation is guaranteed for voltages between 70% and 110% of the rated power supply voltage U_n , in both alternating and direct current. The YO can be permanently supplied.

A remote-controlled emergency opening command can be created by connecting an opening button to the YO.



—
Shunt opening
release - YO

Undervoltage release – YU

This allows the circuit-breaker to open when the release is subject either to a power failure or a voltage drop. As prescribed in the standards, opening is guaranteed when the voltage is between 70% to 35% U_n . After tripping, the circuit-breaker can be closed again if the voltage exceeds 85% U_n . When the undervoltage release is not energized, neither the circuit-breaker nor the main contacts can be closed. A remote-controlled emergency opening command can be generated by connecting an opening button to the YU.



—
Undervoltage
release - YU

None of the service releases require screws to be installed. They are extremely easy to fit: just use a slight pressure on the part indicated in the installation manual. All service releases are available in two versions:

- cabled (AWG16 - minimum cable section 1,25mm²):
 - for fixed/plug-in circuit-breakers with 1m long cables;
 - for withdrawable circuit-breakers with fixed and moving part connectors;
- not cabled:
 - for fixed/plug-in circuit-breakers (suggested cables section 1.5 mm²).

For the fixed version of Tmax XT5, the YO and the YU can be mounted as an alternative in the slot on the left (third pole) or in the slot on the right (first pole) of the operating lever. For the withdrawable version of Tmax XT5, the YO and YU are installed as standard in the first pole. If two different coils are needed in the same circuit-breakers or the YO or YU are required in the third pole (on the left), an uncabled coil and the dedicated cables and connectors for the withdrawable version must be ordered.

Instead, for Tmax XT6 in each versions (withdrawable or fixed) YU can be mounted only in the third pole (on the left) and YO can be mounted only in the first pole (on the right).

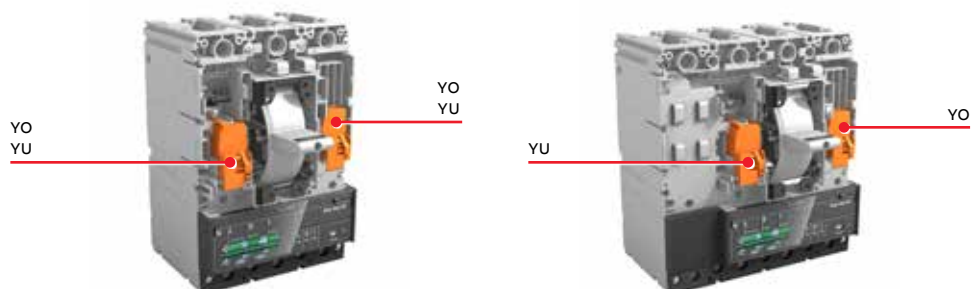

Remote control

Shunt opening release – YO

Version	Max power absorbed on inrush		Current I _{pk} Pull [A]	Power	
	AC [VA]	DC [W]		Pavg Holding [VA]	Pavg Holding [W]
12V DC	-	132	11		3,5
24-60V AC/DC	264@24V	264@24V	11	5	3,5
	660@60V	660@60V			
110...250V AC/DC	363@110V	363@110V	3.3	2,5	2
	825@250V	825@250V			
380-440V AC	304@380V	304@380V	0.8	4,7	
	352@440V	352@440V			
480-525V AC	384@480V	384@480V	0.8	6	
	420@525V	420@525V			

Undervoltage release – YU

Version	Max power absorbed on inrush		Current I _{pk} Pull [A]	Power	
	AC [VA]	DC [W]		Pavg Holding [VA]	Pavg Holding [W]
12V DC	-	132	11		3,5
24-30V AC/DC	330	330	11	6,5	4,5
48-60V AC/DC	660	660		6,5	5,5
110...127V AC-110...125V DC	419	419	3.3	5,2	3,7
220...240V AC-220...250V DC	825	825		5,2	2,6
380-440V AC	352	352	0.8	4,7	
480-525V AC	440	440		6	

XT7 and XT7 M

Shunt opening and shunt closing releases - YO/YC

These opening and closing releases enable the circuit-breaker to be controlled remotely. Opening is always possible, while closing is available only for the XT7 M when the closing springs of the operating mechanism are loaded and the circuit-breakers are ready to close. The releases operate by means of minimum impulse current duration time of 100 ms. Furthermore, they can operate in permanent service. In this case, if the opening command is given by means of the opening release, the circuit-breaker can be closed by de-energizing the opening release and, after a time of at least 30 ms, by controlling the closing. A second open release is an alternative to an undervoltage release.

General characteristics

Power supply (Un)	AC	DC
24V	■	■
30V	■	■
48V	■	■
60V	■	■
110V...120V	■	■
120V...127V	■	■
220V...240V	■	■
240V...250V	■	■
380V...400V	■	-
415V...440V	■	-
480V...500V	■	-
Operating limits (IEC60947-2 standards)	YO/YO2: 70%...110% Un YC/YC2: 85%...110% Un	
Inrush power (Ps)	300VA	300W
Continuous power (Pc)	3.5VA	3.5W
Opening time (YO/YO2)		
XT7-XT7 M	20 ms	
Closing time (YC/YC2)		
XT7-XT7 M	50 ms	



Shunt opening release



Undervoltage release

Undervoltage release – YU

The undervoltage release opens the circuit-breaker when there is a significant voltage drop or power failure. It can be used for safe remote tripping, for blocking closing or to control the voltage in the primary and secondary circuits. The power supply for the release is therefore obtained from the supply side of the circuit-breaker or from an independent source.

Circuit-breaker closing is permitted only when the release is powered. The undervoltage release is an alternative to the second shunt opening release or to the anti-racking out device.

As prescribed in the standards, opening is guaranteed when the voltage is between 70% to 35% U_n . After tripping, the circuit-breaker can be closed again if the voltage exceeds the 85% U_n .

General characteristics

Power supply (U_n)	AC	DC
24V	■	■
30V	■	■
48V	■	■
60V	■	■
110V...120V	■	■
120V...127V	■	■
220V...240V	■	■
240V...250V	■	■
380V...400V	■	-
415V...440V	■	-
480V...500V	■	-
Operating limits (IEC60947-2 standards)	70%...100% U_n	
Inrush power (P_s)	300VA	300W
Continuous power (P_c)	3.5VA	3.5W
Opening time (YU)		
XT7-XT7 M	30 ms	

Remote control



Remote resetting

Remote resetting - YR

Available on the XT7 M only, the YR reset coil permits the remote resetting of the circuit- breaker after a release has tripped due to an overcurrent condition.

General characteristics

Power supply (Un)	AC	DC
24V	■	■
110V	■	■
220V	■	■
Operating limits	90%...110% Un	

Opening and closing release test unit - YO/YC Test Unit

The opening and closing release test unit helps ensure that the releases are running smoothly, to guarantee a high level of reliability in controlling circuit-breaker opening. The test unit ensures the service continuity of the opening and closing releases with a rated operating voltage between 24V and 250V (AC and DC), in addition to verifying the functioning of the opening and closing coils electronic circuit. Continuity is checked cyclically at an interval of 30s between tests. The unit has optic signals via LEDs on the front, which provide the following information:

POWER ON: correct power supply of the YO/YC Test Unit;

OPEN ON: coil switch absent, power supply absent or insufficient, interrupted cables;

SHORT ON: coil switch failure, short-circuited cables;

OPEN and SHORT FLASHING: faulty coil switch or incorrect supply;

OPEN and SHORT OFF: correct operation of the coil switch.

Two relays with one change-over area are also available on board the unit, to allow remote signaling of the following events:

Test failure - resetting takes place automatically when the alarm stops;

Failure of three tests - resetting occurs only by pressing the manual RESET on the unit.

Devices characteristics

Auxiliary power supply	24...250V AC/DC
------------------------	-----------------

Specifications of the signaling relays

Maximum interrupted current	6A
Maximum interrupted voltage	250V AC



Time delay device for undervoltage release

Electronic time-delay device for undervoltage release - UVD

The undervoltage release can be combined with an electronic time-delay device for the circuit-breaker, allowing for delayed external tripping with adjustable preset times. Use of the delayed undervoltage trip unit is recommended to prevent tripping when the power supply network for the trip unit is subject to brief voltage drops or power supply failures. Circuit-breaker closing is inhibited when the UVD is not powered. The time-delay device must be used with an undervoltage release with the same voltage.

Circuit-breaker	Power supply voltage [V AC/DC]
XT1...XT4	24...30
XT1...XT4	48...60
XT1...XT4	110...125
XT1...XT4	220...250
Delay which can be set [s]	0.25 - 0.5 - 0.75 - 1 - 1.25 - 2 - 2.5 - 3
XT5 - XT6	24...30
XT5 - XT6	48...60
XT5 - XT6	110...125
XT5 - XT6	220...250
Delay which can be set [s]	0.5 - 1 - 1.5 - 2 - 3
XT7	24...30
XT7	48
XT7	60
XT7	110...125
XT7	220...250
Delay which can be set [s]	0.5 - 1 - 1.5 - 2 - 3

Motor Operators

These are devices that allow circuit-breaker opening and closing:

- in remote mode, by means of electric controls;
- locally, directly from the front, by means of a special mechanism.

Direct action motor operator - MOD



Direct action motor operator (MOD)

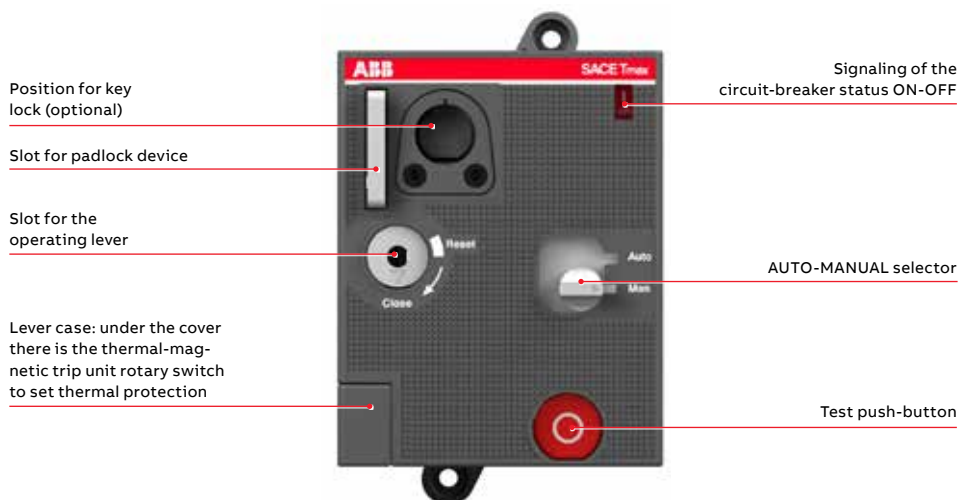

Remote control

The direct action motor operator available for XT1 and XT3 is supplied:

- with 1m long cables;
- with a flange, to replace the standard one supplied with the circuit-breaker;
- with a padlock device, only removable when the motor is in the open position. The padlock device accepts up to three 8 mm padlocks;
- auxiliary contacts (AU-MO), which allow the motor control mode (manual or auto) signal to be routed outside;
- (on request) the motor operator can be fitted with a key lock (see the Chapter "Accessories" - section "Locks").

Operating principles:

- a selector on the front of the MOD, is used for selecting the operating mode:
 - AUTO: when the selector is in this position, the circuit-breaker closing is commanded remotely only by means of an electric impulse, whereas opening is allowed both remotely and from the front of the motor;
 - MANUAL: when the selector is in this position, the circuit-breaker can only be opened/closed from the front of the motor by means of the relative lever housed in a slot made in the motor itself;
- via remote control, guaranteed by permanent electrical opening/closing impulses.

Operating mode: Manual

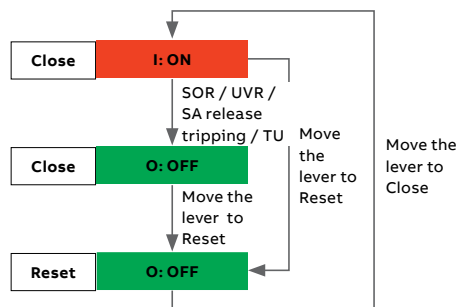

Operating mode: Auto

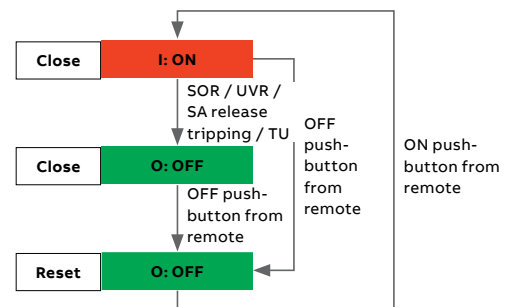

Stored energy motor operators - MOE and MOE-E XT2-XT4



—
Stored energy motor operators (MOE)

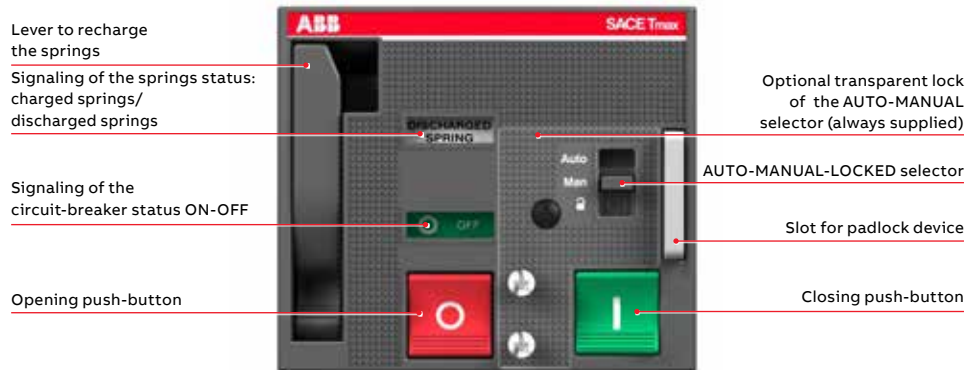

The MOE or MOE-E stored energy motor operator available for XT2 and XT4 is supplied:

- with 1m long cables;
- with connectors for the fixed part and moving part of withdrawable devices. If the motor operator is used with fixed or plug-in circuit-breakers, the connector can be easily removed;
- with a flange, to be used instead of the standard one supplied with the circuit-breaker;
- with a padlock device, which is only removable when the motor is in the open position. The padlock device accepts up to three 8mm padlocks;
- with a lock for the AUTO-MANUAL selector;
- with auxiliary contacts (AUX-MO) that allow the motor control mode (manual or remote) signal to be routed outside;
- (on request) the motor operator can be equipped with a key lock (see the Chapter "Accessories" - section "Locks");
- (on request) the motor operator can be equipped with a key lock to safeguard against manual operation (MOL-M) (see the Chapter "Accessories" - section "Locks").

Operating principles:

- a selector on the front of the MOE, is used for selecting the operating mode:
 - AUTO: when the selector is in this position, the push-buttons on the front of the motor are locked. Circuit-breaker closing is commanded remotely only by means of an electric impulse, whereas opening is allowed both remotely and from the front of the motor;
 - MANUAL: the circuit-breaker can only be opened/closed from the front of the motor using the relative push-buttons;
 - LOCKED: when the selector is in this position, the circuit-breaker is in the open position. The padlock device can be withdrawn and the motor can be locked in the open position;
- operation of the motor operator via remote control is also guaranteed by permanent electrical opening/closing impulses. Once an opening command has been given, the next closing command (permanent) is taken over by the motor operator once the opening has been completed. In the same way, an opening command is taken over once the previous closing operation has been completed;

When the Ekip Com module is used, the MOE-E motor operator must be used instead of the MOE motor operator. The MOE-E allows the digital signals from the supervision and monitoring system to be used by means of the release and Ekip Com contacts and to be converted into power signals to command the motor operator. All the features described above for the MOE motor operator are available also on the MOE-E version.

Remote control

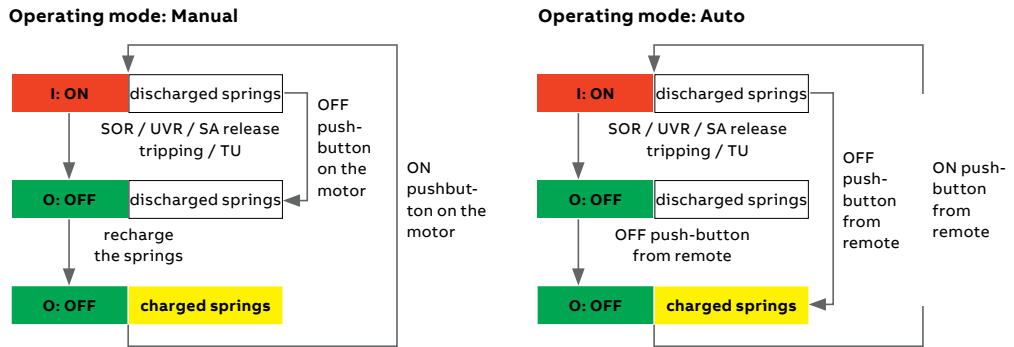

Stored energy motor operators - MOE and MOE-E XT5 and MOE XT6



Stored energy motor operator (MOE)

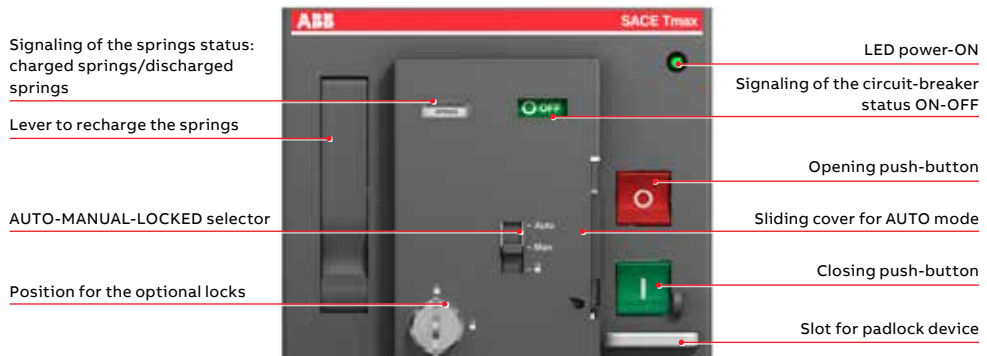

The MOE or MOE-E stored energy motor operator available for the XT5 and XT6 is supplied:

- with 1m long cables;
- with connectors for the fixed part and moving part of withdrawable devices. If the motor operator is used with fixed or plug-in circuit-breakers, the connector can be easily removed;
- with a flange, to use instead of the standard one supplied with the circuit-breaker;
- with a padlock device, only removable when the motor is in the open position. The padlock device accepts up to three 8mm padlocks;
- with a lock for the AUTO-MANUAL selector;
- with auxiliary contacts that allow the motor control mode (manual or remote) signal to be routed outside;
- (on request) the motor operator can be equipped with a key lock (see the Chapter "Accessories" - section "Locks");
- (on request) the motor operator can be equipped with a key lock to safeguard against manual operation (MOL-M) (see the Chapter "Accessories" - section "Locks").

Operating principles:

- a selector on the front of the MOE, is used to select the operating mode:
 - **AUTO:** when the selector is in this position, the push-buttons on the front of the motor are locked and covered by a sliding cover. It is possible to seal the sliding cover to avoid mode changing. Circuit-breaker closing is commanded remotely only by means of an electric impulse, whereas opening is allowed both remotely and from the front of the motor using a tool;
 - **MANUAL:** the circuit-breaker can only be opened/closed from the front of the motor using the relevant push-buttons. It is possible to seal the sliding cover to avoid mode changing;
 - **LOCKED:** the device can be used only if the motor is in the open position and the springs are charged. The padlock device can be withdrawn and the can be motor locked in the open position;
- operation of the motor operator via remote control is also guaranteed by permanent electrical opening/closing impulses. Once an opening command has been given, the next closing command (permanent) is taken over by the motor operator once the opening has been completed. In the same way, an opening command is taken over once the previous closing operation has been completed;

When the Ekip Com module is used, the MOE-E motor operator must be used instead of the MOE motor operator. The MOE-E allows digital signals from the supervision and monitoring system to be used by means of the release and Ekip Com contacts and to be converted into power signals to command the motor operator. All the features described above for the MOE motor operator are also available on the MOE-E version.

Operating mode: Manual

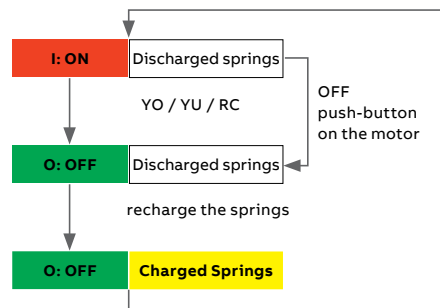

Operating mode: Auto

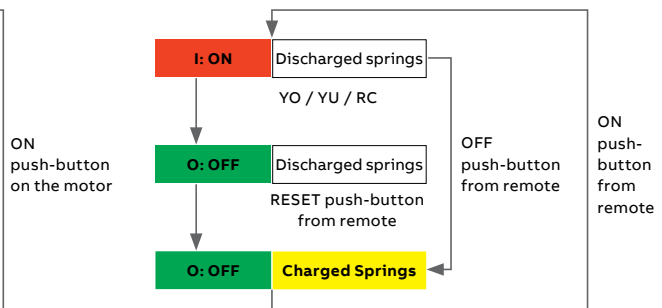

With the XT5 MOE and MOE-E and the XT6 MOE, it is possible to define some reset logic in order to charge the springs automatically once the circuit-breaker has tripped depending on the reset wiring diagram chosen. Three different options are available:

- **Auto Reset:** the circuit-breaker is automatically reset after a trip (not due to the trip unit) and the springs are charged;
- **Remote Reset:** it is possible to connect a push-button in order to charge the springs after a trip (not due to the trip unit);
- **Manual Reset:** charging springs must be done manually after a trip.

As explained in the motor circuit diagram, the auxiliary contact S51 must be properly connected to enable remote or automatic resetting. After a trip due to an overload or a short-circuit (trip unit), only a manual reset is permitted.

Manual Reset

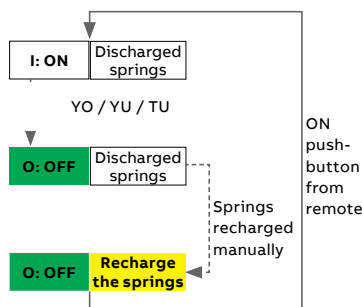

Remote Reset

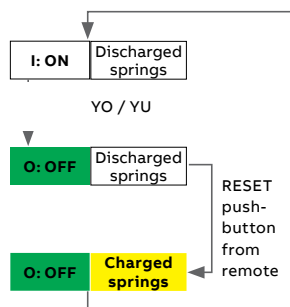

Auto Reset

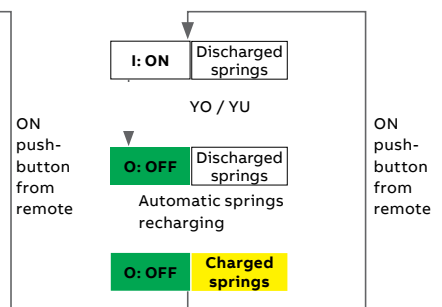

Remote control

Electrical specifications	MOD		MOE and MOE-E		MOE
	XT1 – XT3		XT2 – XT4	XT5	XT6
Rated voltage, Un	[V]	24 DC	24 DC	24 DC	24 DC
	[V]	48...60 DC	48...60 DC	48...60 DC	48...60 DC
	[V]	110...125 AC/DC	110...125 AC/DC	110...125 AC/DC	110...125 AC/DC
	[V]	220...250 AC/DC	220...250 AC/DC	220...250 AC/DC	220...250 AC/DC
	[V]	380...440 AC	380...440 AC	380 AC	380 AC
	[V]	480...525 AC	480...525 AC	-	-
Operating voltage	[% Un]	MIN=85% Un; MAX=110% Un			
Power absorbed on inrush Ps	[VA - W]	≤ 500	≤ 300	≤ 300	≤ 400
Power absorbed on continuing PC service	[VA - W]	≤ 300	≤ 150	≤ 150	≤ 150
Operating frequency	[Hz]	50..60	50..60		
Duration	CL → OP [s]	< 0.1	< 1.5	1.5	3
	OP → CL [s]	< 0.1	< 0.1	< 0.08	< 0.08
	TR → OP [s]	< 0.1	< 3	< 3	< 5
Mechanical life	N° operations	25000	25000	20000	10000
Minimum duration of electrical opening and closing command	[ms]	≥ 150	≥ 150	≥ 100	≥ 100

Motor – M

Available on SACE Tmax XT7 M only, this motor automatically loads the closing springs of the circuit-breaker. The device automatically reloads the springs of the operating device when they are discharged and energized. In the event of a lack of power, the springs can be manually charged by using a dedicated lever on the operating device. The motor of the XT7 M can be equipped with an S33/M contact which signals the status of the springs that must be ordered separately.



Motor operator

Electrical specifications	Motor Operator XT7 M
Rated voltage, Un	[V] 24...30 AC/DC
	[V] 48...60 AC/DC
	[V] 100...130 AC/DC
	[V] 220...250 AC/DC
	[V] 380...415 AC
Operating voltage	[% Un] MIN=85% Un; MAX=110% Un
Power absorbed on inrush Ps	[VA - W] 300
Inrush time	[ms] 200
Power absorbed on continue Pc service	[VA - W] 100
Operating frequency	[Hz] 50..60
Charging time	[s] 8

Safety and protection



Terminal covers

Terminal covers

Terminal covers are applied to the circuit-breaker to prevent accidental contact with live parts, thus providing protection against direct contact. The terminal covers are pre-punched to facilitate the installation of busbars and/or cables, guaranteeing the correct insulation. The terminal covers are able to guarantee adequate circuit-breaker installation and correct insulation and are listed in the Chapter "Power Connection".

There are different types of terminal covers:

- High terminal covers (HTC)
- Low terminal covers (LTC)
- Extended high terminal covers (HTC-ES), for front extended terminals
- High terminal covers with back shield (HTC_BS), with a back plate in order to guarantee insulation with the rear zone of the switchboard.

The table below shows the terminal covers available for each frame:

	XT1		XT2		XT3		XT4		XT5		XT6		XT7/XT7 M	
	3p	4p	3p	4p	3p	4p	3p	4p	3p	4p	3p	4p	3p	4p
HTC - High terminal covers	■	■	■	■	■	■	■	■	■	■	■	■	■	■
LTC - Low terminal covers	■	■	■	■	■	■	■	■	■	■	■	■	■	■
HTC-ES - Extended high terminal covers	-	-	-	-	-	-	-	-	■	■	■	■	■	■
HTC_BS - High terminal cover with back shield	-	-	-	-	-	-	-	-	■	■	■	■	■	■
HTC-ES_BS - Extended high terminal covers with back shield	-	-	-	-	-	-	-	-	■	■	■	■	■	■

Phase separators

Phase separators increase the insulation characteristics between phases at the connection level. They are mounted from the front, even when the circuit-breaker has already been installed, by inserting them into the corresponding slots. The phase separators guarantee adequate circuit-breaker installation and correct insulation and are listed in the Chapter "Power connection".

The following versions of phase separators are available:

- Low phase separators
- Medium phase separators
- High phase separators
- Rear phase separators for fixed part only



Phase separators

		XT1	XT2	XT3	XT4	XT5	XT6	XT7/XT7 M
		[mm]	[mm]	[mm]	[mm]	[mm]	[mm]	[mm]
Phase separator - low	[mm]	25	25	25	25	25	-	-
Phase separator - medium	[mm]	100	100	100	100	100	100	100
Phase separator - high	[mm]	200	200	200	200	200	200	200
Rear phase separator for FP	[mm]	90	90	90	90	90	-	-

Sealable screws for terminal covers

The lead sealing kit consists of screws which prevent the removal of the terminal covers, providing protection against direct contacts and tampering. The screws can be locked with wire and lead seals. Each sealing kit consists of two screws. The maximum number of sealable screws that can be used for each circuit-breaker is given in the table below.



Sealable screws

		XT1		XT2		XT3		XT4	
		3p	4p	3p	4p	3p	4p	3p	4p
Max number sealable screws for each terminal cover	[No.]	1	1	1	1	1	2	1	1

Safety and protection

Padlocks and key locks

Padlocks or key locks prevent the circuit-breaker from being closed and/or opened. They can be fitted:

- directly on the front of the circuit-breaker;
- on the rotary handle operating mechanism;
- on the front for lever operating mechanism;
- on the motor;
- to the fixed part of withdrawable version, to prevent a moving part from being inserted;
- on the front of the thermal-magnetic trip unit, to prevent the adjuster of the thermal part from being tampered with;
- on the shutters of the fixed part.

All locks that hold the circuit-breaker in the open position ensure circuit insulation in accordance with the IEC 60947-2 standard. In the closed position, the locks do not prevent the mechanism from tripping due to the trip unit or a service release.

Padlocks and keylock for circuit-breaker

Type of lock	Circuit-breaker	Optional/standard supply	Position of circuit-breaker lock	Type of lock	Removability of key	
PLL Fixed padlock device	XT1...XT4	Optional	OPEN/CLOSE	Padlocks max 3 padlocks Ø 7mm stem (not supplied)	-	
	XT1...XT4	Optional	OPEN	Padlocks max 3 padlocks Ø 7mm stem (not supplied)	-	
	XT5, XT6	Optional	OPEN/CLOSE	Padlocks max 3 padlocks Ø 8mm stem (not supplied)	-	
	XT5, XT6	Optional	OPEN	Padlocks max 3 padlocks Ø 8mm stem (not supplied)	-	
PLC Fixed padlock device	XT7 ⁽¹⁾	Optional	OPEN	Padlocks max 3 padlocks Ø 8mm stem (not supplied)	-	
	Circuit-breaker	XT7 M	Optional	OPEN	Padlocks max 3 padlocks Ø 4mm stem (not supplied)	-
					Padlocks max 2 padlocks Ø 8mm stem (not supplied)	-
					Padlocks max 1 padlocks Ø 7mm stem (not supplied)	-
PLL Removable padlock device	XT1, XT3	Optional	OPEN	Padlocks max 3 padlocks Ø 7mm stem (not supplied)	-	
	XT5, XT6	Optional	OPEN	Padlocks max 3 padlocks Ø 8mm stem (not supplied)	-	
KLC Key lock ⁽²⁾	XT1...XT7	Optional	OPEN	Ronis 1228 Same key (A, B, C, D type)	OPEN	
	XT1...XT7	Optional	OPEN	Ronis 1228 Different key	OPEN	
	XT1...XT7	Optional	OPEN	Ronis 1228 Same key	OPEN/CLOSE	
	XT7 M	Optional	OPEN	Giussani Same key (20005/6/7/8/9)	OPEN	
	XT7 M	Optional	OPEN	Giussani Different key	OPEN	
KLC Arrangement key lock	XT5...XT6	Optional	OPEN	Kirk, Ronis 1104 and STI key lock	OPEN	
	XT7	Optional	OPEN	Kirk, Ronis 1104, STI and Castell key lock	OPEN	
	XT7 M	Optional	OPEN	Kirk, Ronis 1104, STI and Castell ⁽³⁾ key lock	OPEN	
DLC - Lock to prevent door opening when the circuit-breaker is in the closed position	XT7, XT7 M	Optional	-	This prevents the compartment door from being opened when the circuit-breaker is in the closed position (and with the circuit-breaker racked-in in case of withdrawable circuit-breakers). It also blocks the circuit-breaker from closing when the compartment door is open.	-	

(1) For XT7, the PLL is directly integrated in the plastic cover of the circuit-breaker

(2) For the XT1, XT2, XT3 and XT4, the KLC is incompatible with the electrical accessories mounted on the third pole.

(3) Factory mounted only



Fixed padlock in open position



Fixed padlock in the open/closed position



Removable padlock in the open position - PLL



Key lock



Padlock in the open position - PLC



Keylock - KLC



Lock to prevent door opening - DLC

Padlocks and keylocks for handles



— RHD with key lock



— RHE with key lock

Type of lock	Circuit-breaker	Optional/standard supply	Position of circuit-breaker lock	Type of lock	Removability of key
RHL Key lock ⁽¹⁾	XT1...XT7	Optional	OPEN	Ronis 1228 Same key (A, B, C, D type)	OPEN
	XT1...XT7	Optional	OPEN	Ronis 1228 Different key	OPEN
	XT1...XT7	Optional	OPEN	Ronis 1228 Same key	OPEN/CLOSE
RHL Key lock for panel door with RHE	XT1...XT7	Optional	OPEN	Ronis 1228 Different key	OPEN/CLOSE
Rotary handle (RHD/RHE/RHS)	Padlock device XT1...XT4	standard	OPEN	Padlocks max 3 padlocks Ø 6mm stem (not supplied)	-
	Padlock device XT5...XT7	standard	OPEN	Padlocks max 3 padlocks Ø 8mm stem (not supplied)	-
	Additional padlock device XT5...XT7	standard with dedicated RH code	OPEN	Padlocks max 3 padlocks Ø 8mm stem (not supplied)	-
Door lock ⁽²⁾	XT2, XT4, XT5, XT6	standard	Door locked when CB is closed	-	-

(1) On the transmitted rotary handle (RHE), the lock is mounted on the base. The key lock is not available on the lateral handle (RHS).
 (2) When the handle is assembled, this function can be totally inhibited by the customer with a simple operation that can be reversed if needed. Moreover, if the door lock function is not disabled by the customer during the assembly phase, the door lock can be temporarily excluded with a tool in exceptional cases, so that the door can be opened without opening the circuit-breaker.

Padlocks and keylocks for front for the lever operating mechanism



— FLD with key lock

Type of lock	Circuit-breaker	Optional/standard supply	Position of circuit-breaker lock	Type of lock	Removability of key
KLC Key lock	XT1...XT6	Optional	OPEN	Ronis 1228 Same key (A, B, C, D type)	OPEN
	XT1...XT6	Optional	OPEN	Ronis 1228 Different key	OPEN
	XT1...XT6	Optional	OPEN	Ronis 1228 Same key	OPEN/CLOSE
Front for the lever operating mechanism (FLD)	Padlock device XT1...XT4	standard	OPEN	Padlocks max 3 padlocks Ø 6mm stem (not supplied)	-
	Padlock device XT5...XT6	standard	OPEN	Padlocks max 3 padlocks Ø 8mm stem (not supplied)	-
	Door lock	XT2, XT4, XT5, XT6	standard	Door locked when CB is closed	-

Safety and protection

Padlocks and keylocks for motors



MOD with key lock



MOE with key lock

Type of lock	Circuit-breaker	Optional/standard supply	Position of circuit-breaker lock	Type of lock	Removability of key	
Motor (MOD, MOE, MOE-E)	Key lock on motor MOL-D MOL-S	XT1...XT6	Optional	OPEN	Ronis 1228 Same key (A, B, C, D type)	OPEN
		XT1...XT6	Optional	OPEN	Ronis 1228 Different key	OPEN
	Key lock against manual operation MOL-M ⁽¹⁾	XT2-XT4-XT5-XT6	Optional	MANUAL	Ronis 1228 Different key	WITH LOCK INSERTED
	Padlock device	XT1...XT6	standard	OPEN	Padlocks max 3 padlocks Ø 8mm stem (not supplied)	-

(1) For MOE and MOE-E only.

Padlocks and keylock for fixed parts



Key lock/padlock for withdrawable fixed part



Withdrawable fixed part with key lock/padlock



Padlock in racked-in/test/racked-out position - PLP

Type of lock	Circuit-breaker	Optional/standard supply	Position of circuit-breaker lock	Type of lock	Removability of key	
Fixed part of withdrawable	KLF-FP Key lock / padlock for fixed part of withdrawable device ⁽¹⁾	XT2, XT4, XT5, XT6	Optional	Key WITHDRAWN/ INSERTED/TEST (if available) Padlock WITHDRAWN	Ronis key 1228 Different + padlocks max 3 padlocks Ø 6mm stem (not supplied)	-
		XT2, XT4, XT5, XT6	Optional	Key WITHDRAWN/ INSERTED/TEST (if available) Padlock WITHDRAWN	Ronis key 1228 Same + padlocks max 3 padlocks Ø 6mm stem (not supplied)	-
	Arrangement KLP Key lock in racked-in/ racked/test/ racked-out position - KLP	XT2, XT4	Optional	Key WITHDRAWN/ INSERTED Padlock WITHDRAWN	Giussani key Different + padlocks max 3 padlocks Ø 6mm stem (not supplied)	-
		XT2, XT4	Optional	Key WITHDRAWN/ INSERTED Padlock WITHDRAWN	Giussani key Same + padlocks max 3 padlocks Ø 6mm stem (not supplied)	-
Arrangement KLP Key lock in racked-in/ racked/test/ racked-out position - KLP	XT5, XT6	Optional	Key WITHDRAWN/ INSERTED/TEST (if available) Padlock WITHDRAWN	Arrangement for STI, Ronis 1104 key + padlocks max 3 padlocks Ø 6mm stem (not supplied)	-	
		Optional	Key WITHDRAWN/ INSERTED/ TEST	Giussani Same key (20005/6/7/8/9)	-	
	XT7, XT7 M	Optional	Key WITHDRAWN/ INSERTED/TEST	Giussani Different key	-	
Arrangement KLP Key lock in racked-in/ racked/test/ racked-out position - KLP	XT7, XT7 M	Optional	Key WITHDRAWN/ INSERTED/TEST	Kirk, Ronis 1104, STI and Castell key lock	-	
		Optional	Key WITHDRAWN / INSERTED / TEST	Padlocks max 3 padlocks Ø 8mm stem (not supplied)	-	

(1) For the XT5 and XT6 this lock/padlock can not be used with rear mechanical interlock

Lock for thermal regulation

Type of lock	Circuit-breaker	Optional/standard supply	Position of circuit-breaker lock	Type of lock	Removability of key
Trip Unit	Lock for thermal regulation ⁽¹⁾	XT1, XT3	Optional	-	-
		XT2, XT4, XT5, XT6	standard	-	-

(1) This is applied to the cover of the circuit-breakers on level with the regulator of the thermal element of the thermal-magnetic release TMD and prevents it from being tampered with.

Lock for shutters of fixed parts

Type of lock	Circuit-breaker	Optional/standard supply	Position of circuit-breaker lock	Type of lock	Removability of key
Fixed Part	Shutter lock - SL	XT7, XT7 M	Optional	Padlocks max 3 padlocks Ø 8mm stem (not supplied)	-

IP Protection Kit

In order to improve the IP protection degree, some additional kits can be used.

IP54 Protection flange for direct rotary handle (RHD)

This flange can be mounted with the direct rotary handle of the XT5, XT6 and XT7 to guarantee an IP54 degree of protection.

With this flange is not possible to open the panel door when the circuit-breaker is in the closed position.

IP54 Protection for transmitted rotary handle (RHE)

This device can be fixed onto the transmitted rotary and lateral handle of the XT1, XT2, XT3 and XT4 allowing an IP54 degree of protection to be achieved. The IP degree of the transmitted rotary handle for the XT5, XT6 and XT7 is IP65 as standard without an additional accessory.



IP54 protection



IP54 protection for XT7 M

IP54 Protection flange for the MOE and XT7 M

This transparent cover completely protects the front of the circuit-breaker, guaranteeing an IP54 degree of protection. This accessory is provided with a double key lock (same or different keys).

This cover is available for the XT5 MOE/MOE-E, XT6 MOE and for the XT7 M circuit-breaker.

Safety and protection



Protection device for opening and closing pushbuttons - PBC

Protection device for opening and closing pushbuttons - PBC

This accessory is applied to the safety cover of the XT7 M and is available in two versions.

The push-button protection device blocks the operations on both the opening and closing push-buttons unless a special key is used.

The padlockable push-button protection device makes it possible to block either or both push-buttons and to lock the covers in place. It does not trip the breaker as a standard "Padlock device" would. The protection device for opening and closing push-buttons is an alternative to PLC padlocks.



Mechanical operation counter - MOC

Mechanical operation counter - MOC

The mechanical operation counter is available on the Tmax XT7 M only. This mechanical operation counter is visible on the front of the circuit-breaker and allows the user to see how many mechanical operations the device has performed.



Circuit-breaker with optional flange

Flange

This is a plastic plate that acts as an interface between the circuit-breaker and the hole in the panel door. All the Tmax XT flanges are newly designed and do not require screws for installation. The flanges can be applied:

- around the front part of the fixed/plug-in circuit-breaker;
- around the operating lever for all fixed/plug-in/withdrawable version circuit-breakers;
- around the MOD or MOE motor operator;
- around the front of FLD locks;
- around the direct rotary handle operating mechanism;
- around the RC Inst, RC Sel for the XT1 and XT3, and around the RC Sel for the XT2, XT4 and XT5.



Rotary handle with flange



MOE with flange



XT1-XT3 circuit-breaker with standard flange



XT7 and XT7 M flanges



MOD with flange



XT2-XT4 circuit-breaker with standard flange

Interlocks and switching devices

Operating mechanism		XT1	XT2	XT3	XT4	XT5	XT6	XT7	XT7 M
Rear mechanical interlock	MIR Horizontal	■	■	■	■	■	■	-	-
	MIR Vertical	■	■	■	■	■	■	-	-
Cables interlocks	Type A (2 CBs)	-	-	-	-	-	-	■	■
	Type B, C and D (3 CBs)	-	-	-	-	-	-	■	■
Automatic transfer switch	ATS021	■	■	■	■	■	■	■	■
	ATS022	■	■	■	■	■	■	■	■



Interlock

Rear mechanical interlock

This is a support designed for installation on the rear of two circuit-breakers to be interlocked. It prevents the two circuit-breakers it is installed on from closing simultaneously by linking components. Tmax XT circuit-breakers can be interlocked two-by-two (IO-OI-OO) by means of a chassis and special plates. Interlocked circuit-breakers can be in fixed, plug-in or withdrawable versions. Both circuit-breakers and switch-disconnectors in the 3 and 4 pole versions can be interlocked.

The allowed combinations are:

	XT1	XT2	XT3	XT4	XT5	XT6
XT1	■	■	■	■		
XT2	■	■	■	■		
XT3	■	■	■	■		
XT4	■	■	■	■	■	
XT5				■	■	■
XT6					■	■

The following equipment must be ordered to make a rear interlock:

- a vertical or horizontal chassis;
- a plate for each circuit-breaker to be interlocked.

For using an XT4 on an XT5 chassis and an XT5 on an XT6 chassis, dedicated plates are necessary. Please note that remote closing commands sent to interlocked circuit-breakers in the open position must be prevented in order to ensure the correct functioning of the mechanical interlock. If this is not possible, key locks in the open position for the MOE are necessary.

With the XT5 and XT6 interlock chassis, for withdrawable version circuit-breakers, the use of the key-lock/padlock for fixed parts (KLF) is not allowed.

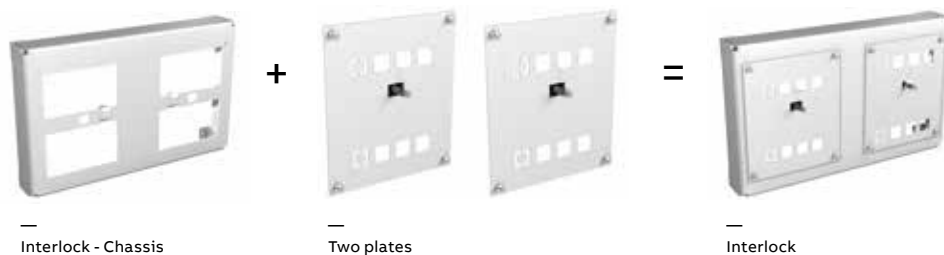

Interlock - Chassis

Two plates

Interlock

Interlocks and switching devices

Cables interlocks

These interlock systems, for the Tmax XT7 and XT7 M, enable various opening and closing configurations to be obtained between two or three circuit-breakers. Four types of interlock configuration are available:

Type A

Excludes the possibility of having two circuit-breakers in the closed position at the same time.

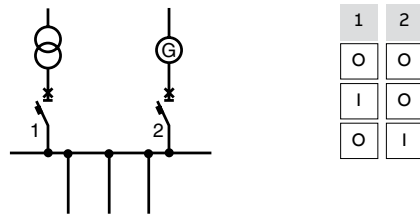

Type B

Permits a pair of circuit-breakers to be closed if the third is open. The latter can only be closed when the paired circuit-breakers are open.

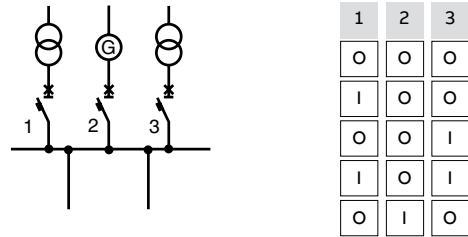

Type C

Permits two out of three circuit-breakers to be closed at the same time.

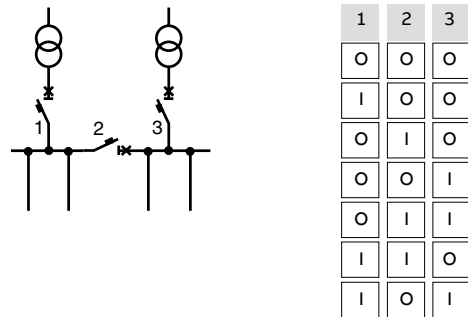

Type D

Permits one out of three interlocked circuit-breakers to be closed.

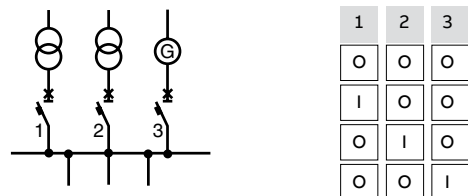



ATS021



ATS022

Automatic network-generator transfer unit ATS021-ATS022

The ATS (Automatic Transfer Switch) is a network-generator transfer unit used in installations where switching the main power line to an emergency line is required to ensure power supply to the loads in case of anomalies in the main line.

The unit is able to manage the entire transfer procedure automatically and prepares the commands for carrying out the procedure manually as well.

In the case of an anomaly in the main line voltage, in accordance with parameters set by the user, the opening of the circuit-breaker of the main line, the starting of the generator set (when provided) and the closing of the emergency line can be carried out. In the same way, when the line is supplied back, the procedure of reverse transfer is controlled automatically.

The new generation of the ATS (ATS021 and ATS022) offers the most advanced and complete solutions to guarantee service continuity. The ATS021 and ATS022 can be used with all the circuit-breakers as well as the switch-disconnectors of the SACE Tmax XT family. The ATS021 and ATS022 devices have been designed to operate with a self-supply. The ATS022 unit also prepares the connection for the auxiliary power supply, which allows additional functions to be used.

The ATS021 and ATS022 devices carry out the control of both the power supply lines and analyze:

- phase unbalance;
- frequency unbalance;
- phase loss.

Apart from the standard control functions, the ATS022 enables the following operations:

- selection of the priority line;
- control of a third circuit-breaker;
- integration of the device in a supervision system with Modbus communication (an auxiliary power supply is needed);
- reading and setting parameters, and displaying measurements and alarms, by means of a graphic display.

Typical applications include: power supply to UPS (Uninterrupted Power Supply) units, operating theaters and primary hospital services, emergency power supplies for civil buildings, airports, hotels, data banks and telecommunication systems, and the power supply of industrial lines for continuous processes.

For the correct configuration, each circuit-breaker connected to the ATS021 or ATS022 must be fitted with the following accessories:

- a mechanical interlock;
- a motorized control for opening and closing;
- a key lock against manual operation for the motor operator;
- a signaling contact for the status (open/closed) and a signaling contact for tripping;
- a contact for the racked-in position (in the case of a withdrawable version circuit-breaker).

Interlocks and switching devices

	ATS021	ATS022
General		
Auxiliary Power Supply	Not Required	Not Required (24-110V DC is required only for Modbus dialogue and 16 2/3 Hz system)
Rated Voltage, Un [VAC]	Max 480	Max 480
Frequency [Hz]	50, 60	16 2/3, 50, 60, 400
Dimensions (HxLxD) [mm]	96x144x170	96x144x170
Type of installation	Door mounting DIN-rail mounting	Door mounting DIN-rail mounting
Operating Mode	Auto/Manual	Auto/Manual
Features		
Monitoring of the Normal and Emergency lines	■	■
Controlling CBs of the Normal and Emergency lines	■	■
Generator set start-up	■	■
Generator set shutdown with adjustable delay	■	■
Bus-tie	-	■
No-priority Line	-	■
Modbus RS485	-	■
Display	-	■
Ambient conditions		
Operating temperature	-20...+60 °C	-20...+60 °C
Humidity	5% - 90% without condensation	5% - 90% without condensation
Operating thresholds		
Minimum voltage	-30%...-5%Un	-30%...-5%Un
Maximum voltage	+5%...+30%Un	+5%...+30%Un
Fixed frequency thresholds	-10%...+10%fn	-10%...+10%fn
Test		
Test Mode	■	■
Compliance with standards		
Electronic equipment for power installations	EN-IEC 50178	EN-IEC 50178
Electromagnetic compatibility	EN 50081-2	EN 50081-2
	EN 50082-2	EN 50082-2
Environmental conditions	IEC 68-2-1	IEC 68-2-1
	IEC 68-2-2	IEC 68-2-2
	IEC 68-2-3	IEC 68-2-3

Residual current protection

Residual current release

Both circuit-breakers and switch-disconnectors are pre-engineered for assembly combined with residual current releases.

Residual current circuit-breakers derived from the circuit-breaker are known as “mixed”, meaning that, besides protection against the typical overloads and short-circuits, they also provide protection for people and against earth fault currents, thus protecting against direct, indirect contacts and risk of fire. Residual current circuit-breakers derived from switch-disconnectors are “pure” residual current circuit-breakers, i.e. they only provide residual current protection and not the protection typical of circuit-breakers. “Pure” residual current circuit-breakers are only sensitive to earth fault currents and are generally used as main switches in small panels for distribution to end users.

Use of “pure” and “mixed” residual current circuit-breakers allows the insulation state of the installation to be continuously monitored. It ensures efficient protection against the risk of fire and explosions and also protects people against indirect and direct contacts, thereby integrating the compulsory measures established by the accident prevention standards and Regulations.

The residual current releases comply with the following standards:

- IEC 60947-2 Annex B;
- IEC 61000 for protection against unwanted tripping.

The table gives all the residual current devices that can be used in combination with SACE Tmax XT family:

		XT1		XT2		XT3		XT4		XT5	
		3p	4p	3p	4p	3p	4p	3p	4p	3p	4p
Instantaneous residual current device	RC Inst	F	F			F	F				
Selective residual current device	RC Sel XT1-XT3	F	F			F	F				
	RC Sel 200		F								
	RC Sel XT2-XT4					F-P-W				F-P-W	
	RC Sel XT5										F-P-W
Type B residual current device	RC Type B XT3						F				

Tmax XT residual current devices:

- are designed for XT1, XT2, XT3 and XT4 microprocessor technology and act directly on the circuit-breaker by means of a dedicated opening solenoid (supplied with the residual current release and also available as a spare part) which must be housed in the relevant slot formed in the third pole on the left of the operating lever;
- are designed for XT5 feature microprocessor technology and act directly on the circuit-breaker by means of a dedicated mechanism integrated in the residual current itself;
- do not need an auxiliary supply as they are powered directly from the mains;
- can be supplied either from above or below;
- provide guaranteed functionality even with a single phase plus neutral or just two live phases and in the presence of pulsating unidirectional currents with direct components (minimum auxiliary voltage PHASE-NEUTRAL 85 Vrms);
- permit all possible connection combinations, as long as the neutral connection to the first pole on the left in the four-pole version is guaranteed.

Residual current protection

RC Sel residual current releases (type A) XT1

Thanks to its low height, the RC Sel 200 residual current release can be installed in 200mm modules. Moreover, its special shape reduces the overall size of the installation if two or more units are installed side by side.

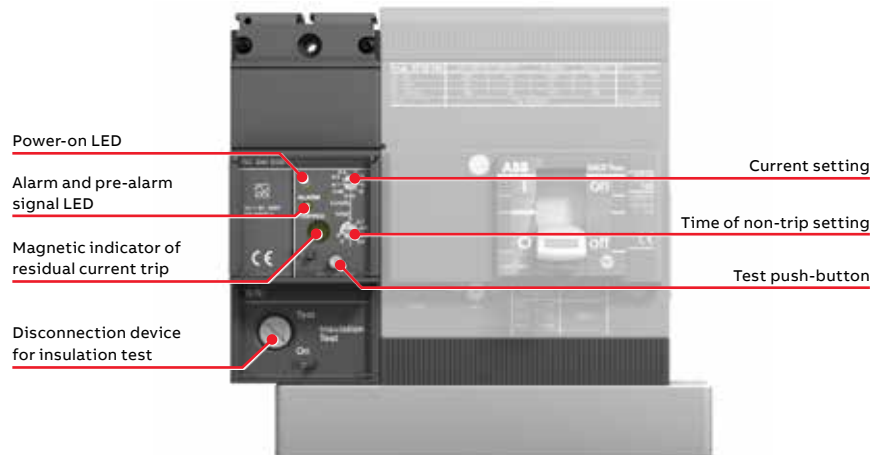

RC Inst residual current releases for XT1 and XT3

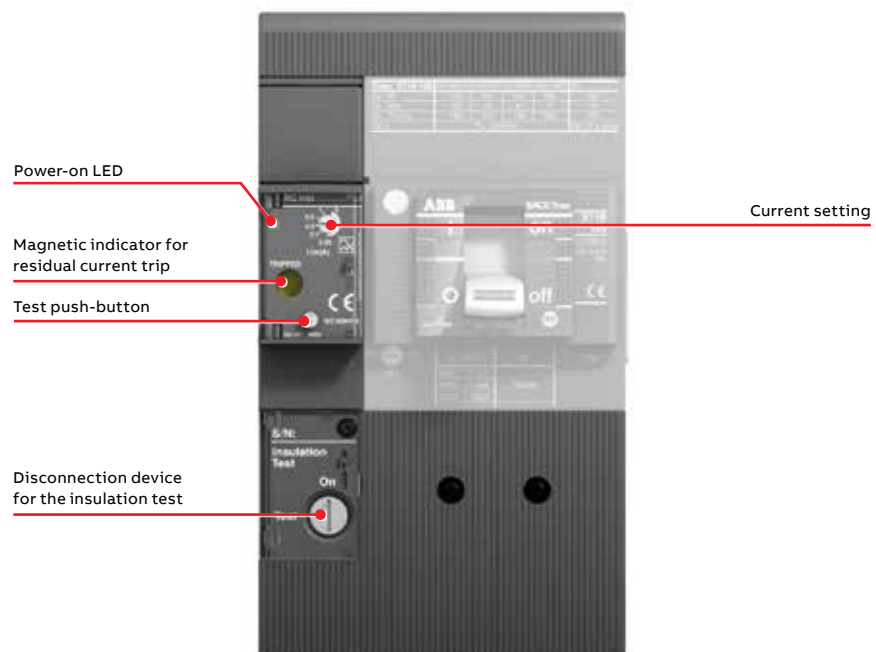

RC Sel current releases (type A) for XT1 and XT3

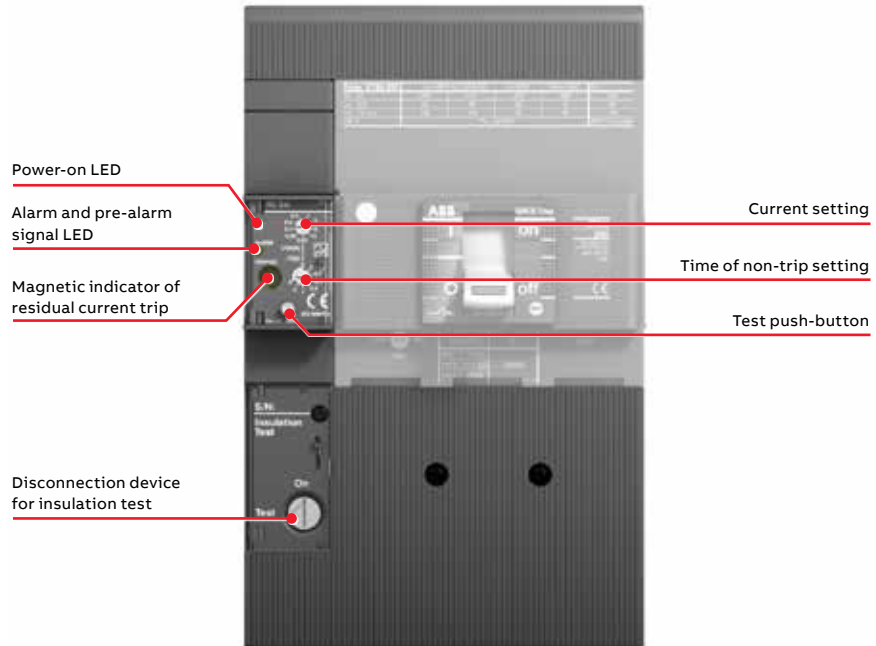

With the RC Inst and RC Sel residual current releases for the XT1 - XT3 available in fixed versions only, it is possible to make rear terminal connections by ordering the RC Rear terminal 4p kits.

RC Sel residual current releases for XT2 and XT4

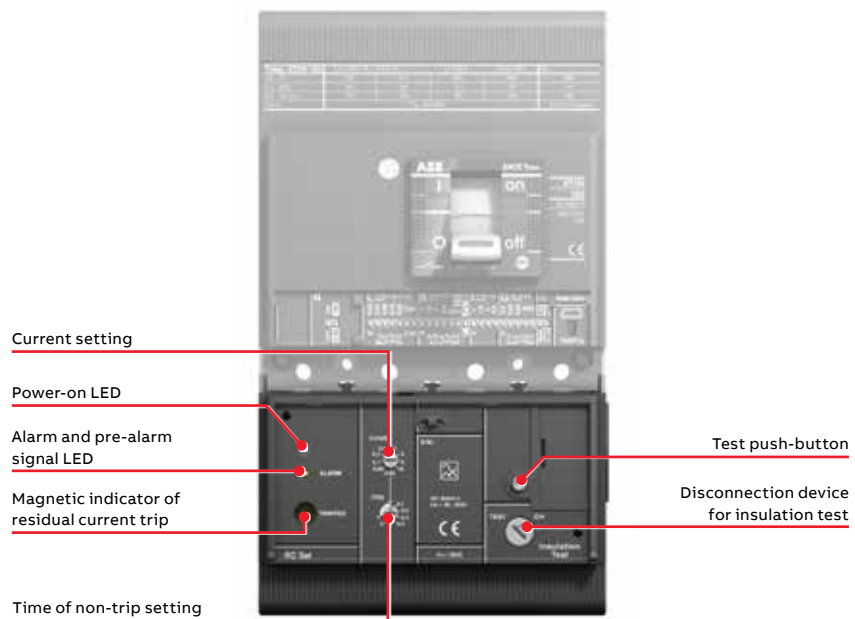

Residual current protection

The fixed version of the RC Sel residual current release can be easily converted:

- into a plug-in type of release:
 - by ordering the kit for converting the residual current release from the fixed to the plug-in version
- into a withdrawable type of release:
 - by ordering the kit for converting the residual current release from the plug-in to the withdrawable version. This kit contains the shunt opening release of the withdrawable residual current device to replace the shunt opening release supplied with the fixed version. The shunt opening release of the withdrawable residual current device contains both the connector for the moving part and the connector for the fixed part.

With the RC Sel residual current release for the XT2-XT4, it is possible to use the same terminals for the fixed circuit-breaker and for the fixed parts of the plug-in and withdrawable circuit-breakers.

With the withdrawable and plug-in versions, frame 160A with RC can be used up to a maximum current of 135A, whereas frame 250A can be used up to 210A.

RC Sel current releases (type A) for XT5

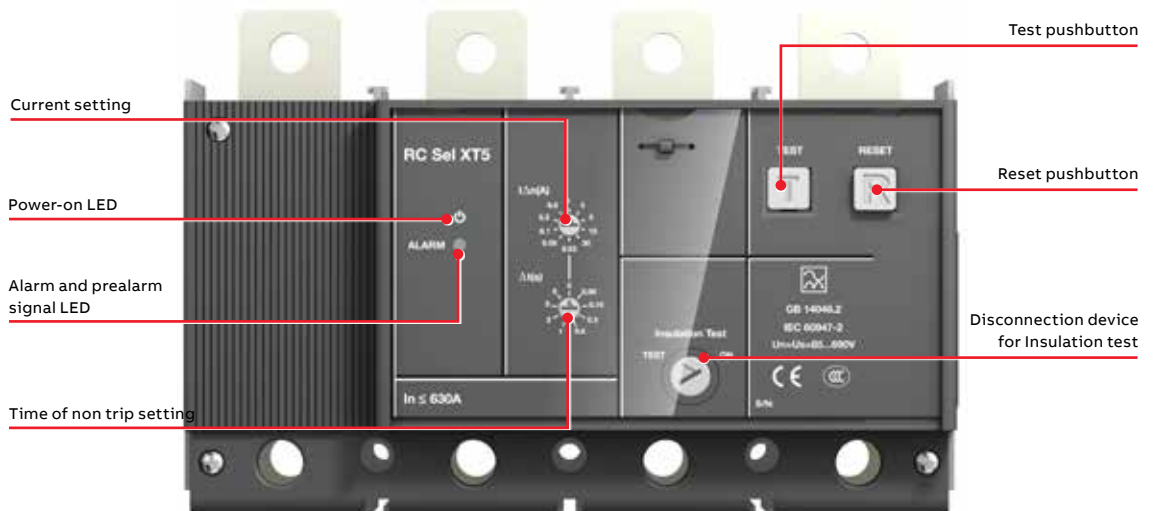

The fixed version of the RC Sel residual current release can easily be converted:

- into a plug-in type of release:
 - by ordering the kit for converting the residual current release from the fixed to the plug-in version
- into a withdrawable type of release:
 - by ordering the kit for converting the residual current release from the plug-in to the withdrawable version. This kit contains the shunt opening release of the withdrawable residual current device to replace the shunt opening release supplied with the fixed version. The shunt opening release of the withdrawable residual current device contains both the connector for the moving part and the connector for the fixed part.

With the RC Sel residual current release for the XT5, it is possible to use the same terminals for the fixed circuit-breaker and for the fixed parts of the plug-in and withdrawable circuit-breakers.

RC Sel for XT5 is always a four poles version that can be mounted also on a three-pole circuit breakers using the dedicated cover supplied in the RC kit.

RC B Type residual current releases (type B) for XT3

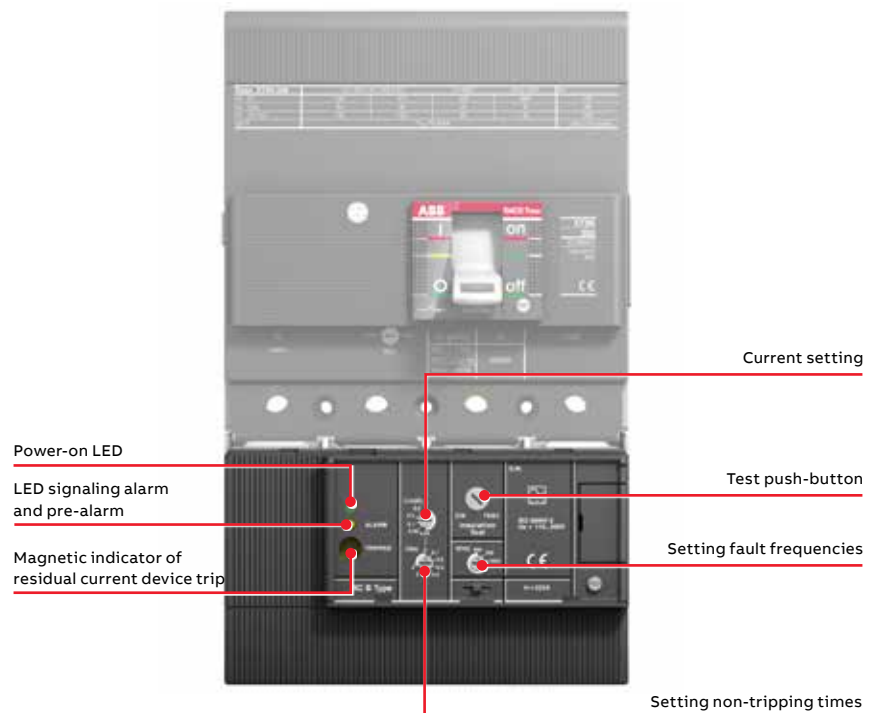

The RC residual current release type B, to be used in conjunction with the XT3 circuit-breaker, has the following features:

- it complies with type B operation, which guarantees sensitivity to residual fault currents with alternating, pulsating alternating and direct current components (in compliance with the standards 60947-1, IEC 60947-2 Annex B, IEC/TR 60755);
- the maximum frequency band of the residual fault current detection can be selected (3 steps: 400 - 700 - 1000Hz). The residual current device can therefore be adapted to suit various industrial installation requirements according to the prospective fault frequencies generated on the load side of the release. Typical installations that may require different frequency thresholds from the standard ones (50 - 60Hz) include welding systems for the automobile industry (1000Hz), the textile industry (700Hz), airports and three-phase drives (400Hz).

Residual current protection

Electrical characteristics	Residual current devices				
	RC Sel 200 XT1	RC Inst XT1-XT3	RC Sel XT1-XT3	RC Sel XT2-XT4	RC Sel XT5 ⁽³⁾
Primary power supply voltage [V]	85...690	85...690	85...690	85...690	85...500
Operating frequency [Hz]	45...66	45...66	45...66	45...66	45...66
Fault frequency [Hz]	50-60	50-60	50-60	50-60	50-60
Test operating range [V]	85...690	85...690	85...690	85...690	85...500
Rated operating current [A]	up to 160	XT1 up to 160 XT3 up to 250	up to 160 XT1 up to 250 XT3	up to 160 XT2 ⁽²⁾ up to 250 XT4 ⁽²⁾	up to 550 ⁽²⁾
Adjustable trip thresholds [A]	0.03-0.05-0.1- 0.3-0.5-1-3-5-10	0.03-0.1-0.3 0.5-1-3	0.03-0.05-0.1- 0.3-0.5-1-3-5-10	0.03-0.05-0.1- 0.3-0.5-1-3-5-10	0.03-0.05-0.1-0.3 0.5-1-3-5-10-30
Selective type S	■	-	■	■	■
Adjustable NON-trip time settings [s] at 2xIΔn	Instantaneous 0.1-0.2-0.3- 0.5-1-2-3	Instantaneous	Instantaneous 0.1-0.2-0.3- 0.5-1-2-3	Instantaneous 0.1-0.2-0.3- 0.5-1-2-3	Instantaneous 0.06-0.15-0.3- 0.5-1-2-3-5
Power input	<5 W at 690V AC	<5 W at 690V AC	<5 W at 690V AC	<5 W at 690V AC	<5 W at 500V AC
Trip Coil with switch contact for trip signal	■	■	■	■	■
Input for remote controlled opening command	■	-	■	■	■
NO contact for pre-alarm signal	■	-	■	■	■
NO contact for alarm signal	■	-	■	■	■
Pre-alarm indication from 25% IΔn. Steady yellow LED light	■	-	■	■	■
Alarm timing indication at 75% IΔn. Flashing yellow LED light ⁽¹⁾	■	-	■	■	■
Type A for pulsating alternating current	■	■	■	■	■
Type AC for alternating current	■	■	■	■	■

(1) Indication of alarm timing at 90% IΔn for 30mA for XT1, XT2, XT3 and XT4. Indication of alarm timing at 75%IΔn for 30mA for XT5

(2) Plug-in and withdrawable version: the 160 frame can be used with a max In = 135A
the 250 frame can be used with a max In = 210A
the 630 frame can be used with a max In = 500A

(3) Only for circuit-breakers with Icu up to 100kA@415V (N-S-H-L versions)

Electrical characteristics	Residual current devices
	RC B Type XT3
Primary power supply voltage [V]	110...500
Operating frequency [Hz]	45...66
Fault frequency [Hz]	400-700-1000
Test operating range [V]	110...500
Rated operating current [A]	up to 225
Adjustable trip thresholds [A]	0.03-0.05-0.1-0.3-0.5-1
Selective type S	■
Adjustable NON-trip time settings [s] at $2 \times I_{\Delta n}$	Instantaneous 0-0.1-0.2-0.3-0.5-1-2-3
Power input	<10 W at 500V AC
Trip Coil with switch contact for trip signal	■
Input for remote controlled opening command	■
NO contact for pre-alarm signal	■
NO contact for alarm signal	■
Steady yellow LED light	■
Flashing yellow LED light ⁽¹⁾	■
Type A for pulsating alternating current, Type AC for alternating current	■
Type B for pulsating current and direct current	■

(1) Indication of alarm timing at 90% $I_{\Delta n}$ for 30mA

Residual current protection

SACE RCQ020 panel type residual current release

SACE Tmax XT circuit-breakers can also be used in conjunction with RCQ020 panel type residual current releases with a separate toroid to be installed on the line conductors (“/A” indicates the necessity for an auxiliary power supply).

Thanks to its wide range of settings, the panel release is suitable for:

- applications where the installation conditions are particularly restrictive, such as for circuit-breakers that are already installed or where there is limited space in a compartment where the circuit-breaker is installed;
- creating a residual current protection system coordinated at various distribution levels, from the main switchboard to the end user;
- where residual current protection with low sensitivity is required, e.g. in partial (current) or total (time) selective chains;
- highly sensitive applications (physiological sensitivity) for protecting people against direct contacts.

Thanks to the 115-230...415V external auxiliary power supply, the RCQ020 panel type residual current device is able to detect current leakages from 30mA to 30A and to act with a trip time that can be adjusted from instantaneous to a delay of 5s. The opening mechanism is an indirect action type and acts on the circuit-breaker release mechanism by means of the shunt opening or an undervoltage release of the circuit-breaker itself.

The opening command to the circuit-breaker (trip delay) can be temporarily inhibited, and the circuit-breaker can be opened by remote control by means of the RCQ020 device.

The following equipment must be requested when ordering:

- the RCQ020 device itself;
- an opening coil (SOR) or an undervoltage release (UVR) of the circuit-breaker to be housed in the relative slot made in the left pole of the circuit-breaker itself;
- a closed toroid, which can be used for both cables and busbars, with a diameter from 60mm to 185mm.

Signals available:

- LED to indicate the status of the residual current device (supplied or not supplied). The RCQ020 is equipped with a positive safety function thanks to which the RCQ020 sends an automatic circuit-breaker opening command in the absence of auxiliary voltage;
- LED for fault signaling;
- LED for signaling tripping of the residual current device;
- electrical pre-alarm/alarm/trip signals.

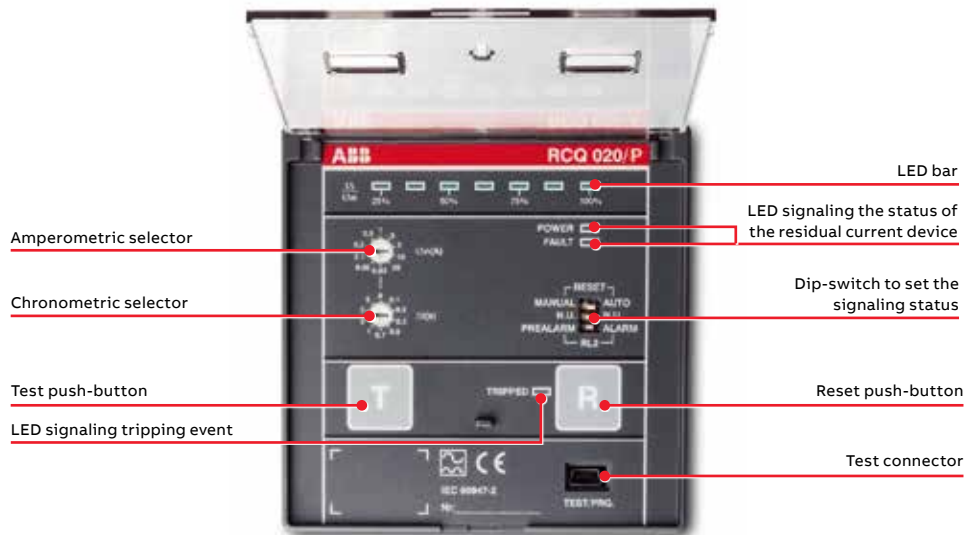
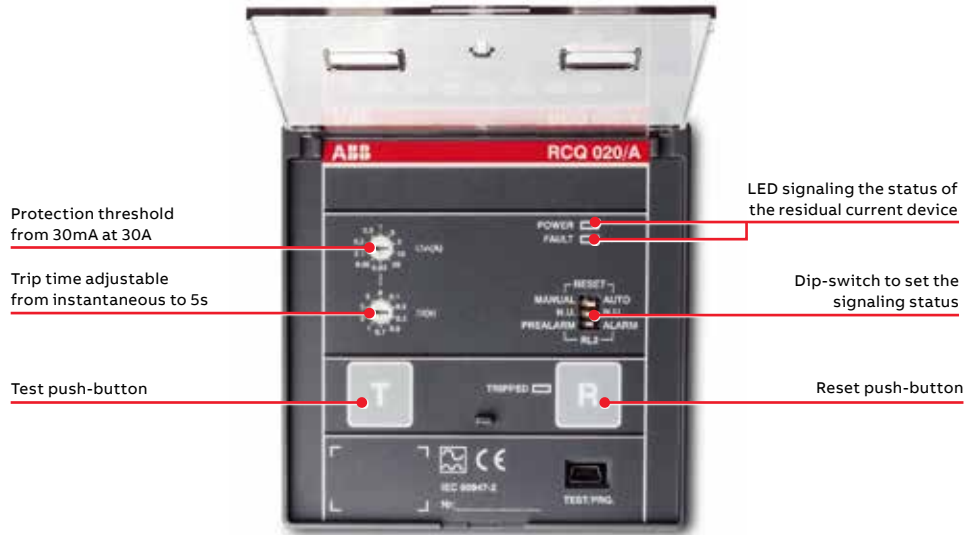

Residual current protection

Power supply Voltage	/A	AC [V]	115-230...415
	/P	AC [V]	110...690
	/P	DC [V]	110...125
Operating frequency		[Hz]	45÷66
Inrush current	/A	@115 V AC	500 mA for 50 ms
	/A	@230 V AC	150 mA for 50 ms
	/A	@415 V AC	100 mA for 50 ms
	/P	@110 V AC	300 mA for 50 ms
	/P	@690 V AC	2 A for 50 ms
	/P	@125 V DC	500 mA for 50 ms
Rated Power	/A		2 [VA] / 2 [W]
	/P	@115 V AC	max 3 W
	/P	@230 V AC	max 3 W
	/P	@690 V AC	max 4 W
	/P	@125 V DC	max 2 W
Trip threshold adjustment I Δ n		[A]	0.03-0.05-0.1-0.3-0.5-1-3-5-10-30
No trip time adjustment		[s]	instantaneous 0.1-0.2-0.3-0.5-0.7-1-2-3-5
Pre-alarm threshold		x I Δ n	25%
A type for pulsing alternate current			■
Signals			
Device powered visual signaling			■
Visual signaling of device not functioning / not configured			■
Visual signaling of residual current protection			■
Electrical alarm/pre-alarm signal			■
Electric trip signal			■
Controls			
Remotely controlled opening command			■
Remotely controlled reset command			■
Operating range of closed transformers			
Ø 60 [mm] toroidal transformer		[A]	In max = 250 A - Use 0.03...30 A
Ø 110 [mm] toroidal transformer		[A]	In max = 400 A - Use 0.03...30 A
Ø 185 [mm] toroidal transformer		[A]	In max = 800 A - Use 0.1...30 A
Connection to toroidal transformer			By means of 4 shielded or twisted conductors. Maximum tolerated length: 15 m
Dimensions W x H x D		[mm]	96 x 96 x 77
Drilling for assembly on door		[mm]	92 x 92
standard			IEC 60947-2 annex M

Compatibility of accessories

Fixed and plug-in versions

Check whether the different devices are compatible/incompatible with each other when ordering accessories. The following table provides a simple check of the compatibility between mechanical and electrical accessories. To understand the abbreviations used to identify the accessories more easily, refer to the "Glossary" at the end of the section.



Three-pole circuit-breaker

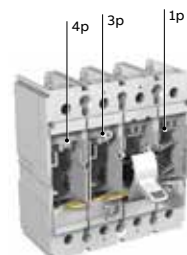

Four-pole circuit-breaker

How to read compatibility tables - an example

Fixed/plug-in circuit-breaker compatibility XT1-XT3

	SOR 3p	UVR 3p	3Q 3p	SOR 4p	UVR 4p
SOR 3p	2	3	4	5	6	
UVR 3p ¹	2	3	4	5	6	
3Q sx 3p						
SOR 4p	✓	✓	✓		✓	
UVR 4p	✓	✓	✓	✓ [...]		
[...]						

The UVR positioned in the slot of the 3rd pole⁽¹⁾ is:

- incompatible with the SOR positioned on the 3rd pole⁽²⁾;
- incompatible with the UVR positioned on the 3rd pole⁽³⁾;
- incompatible with the 3Q contacts on the left of the 3rd pole⁽⁴⁾;
- compatible with the SOR positioned in the slot of the 4th pole⁽⁵⁾;
- compatible with the UVR positioned in the slot of the 4th pole⁽⁶⁾;
- [...]

Tmax XT1-XT3

	RHD	RHE	RHS	FLD	MOD	PLL on CB	KLC on CB	RHL	MOL on motor	SOR/UVR 3p	3Q left 3p	RC Coil 3p	SOR/UVR 4p	3Q left 4p	1Q+1SY	2Q+1SY	3Q+1SY	AUE
RHD								✓		✓	✓	✓	✓	✓	✓	✓	✓	✓
RHE								✓		✓	✓	✓	✓	✓	✓	✓	✓	✓
RHS										✓	✓	✓	✓	✓	✓	✓	✓	✓
FLD								✓		✓	✓	✓	✓	✓	✓	✓	✓	✓
MOD									✓	✓	✓	✓	✓	✓	✓	✓ ⁽¹⁾	✓ ⁽²⁾	✓
PLL on CB										✓	✓	✓	✓	✓	✓	✓	✓	✓
KLC on CB													✓	✓	✓	✓	✓	✓
RHL	✓	✓		✓						✓	✓	✓	✓	✓	✓	✓	✓	✓
MOL on motor					✓					✓	✓		✓	✓	✓	✓	✓	✓
SOR/UVR 3p	✓	✓	✓	✓	✓	✓		✓	✓				✓	✓	✓	✓	✓	✓
3Q left 3p	✓	✓	✓	✓	✓	✓		✓	✓				✓	✓	✓	✓	✓	✓
RC Coil 3p	✓	✓	✓	✓	✓	✓		✓					✓	✓	✓	✓	✓	✓
SOR/UVR 4p	✓	✓	✓	✓	✓	✓	✓	✓	✓	✓	✓	✓			✓	✓	✓	✓
3Q left 4p	✓	✓	✓	✓	✓	✓	✓	✓	✓	✓	✓	✓			✓	✓	✓	✓
1Q+1SY	✓	✓	✓	✓	✓	✓	✓	✓	✓	✓	✓	✓	✓	✓				✓
2Q+1SY	✓	✓	✓	✓	✓	✓	✓	✓	✓	✓	✓	✓	✓	✓				✓
3Q+1SY	✓	✓	✓	✓	✓ ⁽²⁾	✓	✓	✓	✓	✓	✓	✓	✓	✓				✓
AUE	✓	✓						✓		✓	✓	✓	✓	✓	✓	✓	✓	✓

✓ Compatible; (1) Not valid for XT1; (2) Not valid for XT3

Compatibility of accessories

Tmax XT2-XT4

Circuit-breakers with thermal-magnetic or electronic Ekip Dip trip units

	RHD	RHE	RHS	FLD	MOE/MOE-E	PLL on CB	KLC on CB	RHL	MOL on motor	SOR/UVR 3p	3Q left 3p	RC Coil 3p	SOR/UVR 4p	3Q left 4p	1Q+1SY	2Q+1SY	3Q+1SY	3Q+2SY	2Q+2SY+1S51	1S51	400V 2Q	400V 1Q+1SY	AUE	Ekip COM STA RTU / Ekip COM LSI-LSIG ⁽¹⁾	Ekip COM STA TCP
RHD								✓		✓	✓	✓	✓	✓	✓	✓	✓	✓	✓	✓	✓	✓	✓	✓	✓
RHE								✓		✓	✓	✓	✓	✓	✓	✓	✓	✓	✓	✓	✓	✓	✓	✓	✓
RHS										✓	✓	✓	✓	✓	✓	✓	✓	✓	✓	✓	✓	✓	✓	✓	✓
FLD								✓		✓	✓	✓	✓	✓	✓	✓	✓	✓	✓	✓	✓	✓	✓	✓	✓
MOE/MOE-E									✓	✓	✓	✓	✓	✓	✓	✓	✓	✓	✓	✓	✓	✓	✓	✓	✓
PLL on CB										✓	✓	✓	✓	✓	✓	✓	✓	✓	✓	✓	✓	✓	✓	✓	✓
KLC on CB													✓	✓	✓	✓	✓	✓	✓	✓	✓	✓	✓	✓	✓
RHL	✓	✓		✓						✓	✓	✓	✓	✓	✓	✓	✓	✓	✓	✓	✓	✓	✓	✓	✓
MOL on motor					✓					✓	✓	✓	✓	✓	✓	✓	✓	✓	✓	✓	✓	✓	✓	✓	✓
SOR/UVR 3p	✓	✓	✓	✓	✓	✓		✓	✓				✓	✓	✓	✓	✓	✓	✓	✓	✓	✓	✓	✓	✓
3Q left 3p	✓	✓	✓	✓	✓	✓		✓	✓				✓	✓	✓	✓	✓	✓	✓	✓	✓	✓	✓	✓	✓
RC Coil 3p	✓	✓	✓	✓	✓	✓		✓	✓				✓	✓	✓	✓	✓	✓	✓	✓	✓	✓	✓	✓	✓
SOR/UVR 4p	✓	✓	✓	✓	✓	✓		✓	✓				✓	✓	✓	✓	✓	✓	✓	✓	✓	✓	✓	✓	✓
3Q left 4p	✓	✓	✓	✓	✓	✓		✓	✓				✓	✓	✓	✓	✓	✓	✓	✓	✓	✓	✓	✓	✓
1Q+1SY	✓	✓	✓	✓	✓	✓		✓	✓	✓	✓	✓	✓	✓	✓	✓	✓	✓	✓	✓	✓	✓	✓	✓	✓
2Q+1SY	✓	✓	✓	✓	✓	✓		✓	✓	✓	✓	✓	✓	✓	✓	✓	✓	✓	✓	✓	✓	✓	✓	✓	✓
3Q+1SY	✓	✓	✓	✓	✓	✓		✓	✓	✓	✓	✓	✓	✓	✓	✓	✓	✓	✓	✓	✓	✓	✓	✓	✓
3Q+2SY	✓	✓	✓	✓	✓	✓		✓	✓	✓	✓	✓	✓	✓	✓	✓	✓	✓	✓	✓	✓	✓	✓	✓	✓
2Q+2SY+1S51	✓	✓	✓	✓	✓	✓		✓	✓	✓	✓	✓	✓	✓	✓	✓	✓	✓	✓	✓	✓	✓	✓	✓	✓
1S51	✓	✓	✓	✓	✓	✓		✓	✓	✓	✓	✓	✓	✓	✓	✓	✓	✓	✓	✓	✓	✓	✓	✓	✓
400V 2Q	✓	✓	✓	✓	✓	✓		✓	✓	✓	✓	✓	✓	✓	✓	✓	✓	✓	✓	✓	✓	✓	✓	✓	✓
400V 1Q+1SY	✓	✓	✓	✓	✓	✓		✓	✓	✓	✓	✓	✓	✓	✓	✓	✓	✓	✓	✓	✓	✓	✓	✓	✓
AUE	✓	✓						✓	✓	✓	✓	✓	✓	✓	✓	✓	✓	✓	✓	✓	✓	✓	✓	✓	✓
Ekip COM STA RTU / Ekip COM LSI-LSIG ⁽¹⁾	✓	✓	✓	✓	✓	✓		✓	✓	✓	✓	✓	✓	✓	✓	✓	✓	✓	✓	✓	✓	✓	✓	✓	✓
Ekip COM STA TCP	✓	✓	✓	✓	✓	✓		✓	✓	✓	✓	✓	✓	✓	✓	✓	✓	✓	✓	✓	✓	✓	✓	✓	✓

✓ Compatible

(1) Ekip COM LSI-LSIG is only available with Ekip LSI and LSIG trip units

Circuit-breakers with electronic Ekip Touch and Ekip Hi-Touch trip units

	RHD	RHE	RHS	FLD	MOE/MOE-E	PLL ON CB	KLC ON CB	RHL	MOL ON MOTOR	SOR/UVR 3P	3Q LEFT 3P	RC COIL 3P	SOR/UVR 4P	3Q LEFT 4P	AUE	EKIP COM
RHD								✓		✓	✓	✓	✓	✓	✓	✓
RHE								✓		✓	✓	✓	✓	✓	✓	✓
RHS										✓	✓	✓	✓	✓		✓
FLD								✓		✓	✓	✓	✓	✓		✓
MOE/MOE-E									✓	✓	✓	✓	✓	✓		✓
PLL on CB										✓	✓	✓	✓	✓		✓
KLC on CB													✓	✓		✓
RHL	✓	✓		✓						✓	✓	✓	✓	✓	✓	✓
MOL on motor					✓					✓	✓	✓	✓	✓		✓
SOR/UVR 3p	✓	✓	✓	✓	✓	✓		✓	✓				✓	✓	✓	✓
3Q left 3p	✓	✓	✓	✓	✓	✓		✓	✓				✓	✓	✓	✓
RC Coil 3p	✓	✓	✓	✓	✓	✓		✓	✓				✓	✓	✓	✓
SOR/UVR 4p	✓	✓	✓	✓	✓	✓	✓	✓	✓	✓	✓	✓			✓	✓
3Q left 4p	✓	✓	✓	✓	✓	✓	✓	✓	✓	✓	✓	✓			✓	✓
AUE	✓	✓						✓		✓	✓	✓	✓	✓		✓
Ekip COM	✓	✓	✓	✓	✓	✓	✓	✓	✓	✓	✓	✓	✓	✓	✓	✓

✓ Compatible

Compatibility of accessories

Tmax XT5

Circuit-breakers with thermal-magnetic or electronic Ekip Dip trip units

	RHD	RHE	CK RHE->RHS	FLD	MOE/MOE-E	PLL on CB	KLC on CB	RHL	MOL on motor	YO/YU 3p	YO/YU 1p	1Q+1SY	1Q+1SY left	2Q+1SY	3Q+1SY	1S51	1S52	400V 2Q	400V 1Q+1SY	AUE	Ekip COM STA RTU/TCP	
RHD								✓		✓	✓	✓	✓	✓	✓	✓	✓	✓	✓	✓	✓	✓
RHE			✓					✓		✓	✓	✓	✓	✓	✓	✓	✓	✓	✓	✓	✓	✓
CK RHE->RHS		✓						✓		✓	✓	✓	✓	✓	✓	✓	✓	✓	✓	✓	✓	✓
FLD								✓		✓	✓	✓	✓	✓	✓	✓	✓	✓	✓	✓	✓	✓
MOE/MOE-E									✓	✓	✓	✓	✓	✓	✓	✓	✓	✓	✓	✓	✓	✓
PLL on CB										✓	✓	✓	✓	✓	✓	✓	✓	✓	✓	✓	✓	✓
KLC on CB											✓	✓	✓	✓	✓	✓	✓	✓	✓	✓	✓	✓
RHL	✓	✓	✓	✓						✓	✓	✓	✓	✓	✓	✓	✓	✓	✓	✓	✓	✓
MOL on motor					✓					✓	✓	✓	✓	✓	✓	✓	✓	✓	✓	✓	✓	✓
YO/YU 3p	✓	✓	✓	✓	✓	✓		✓	✓		✓	✓	✓	✓	✓	✓	✓	✓	✓	✓	✓	✓
YO/YU 1p	✓	✓	✓	✓	✓	✓	✓	✓	✓	✓		✓	✓	✓	✓	✓	✓	✓	✓	✓	✓	✓
1Q+1SY	✓	✓	✓	✓	✓	✓	✓	✓	✓	✓	✓		✓			✓	✓	✓	✓	✓	✓	✓
1Q+1SY left	✓	✓	✓	✓	✓	✓	✓	✓	✓	✓	✓	✓		✓		✓	✓	✓	✓	✓	✓	✓
2Q+1SY	✓	✓	✓	✓	✓	✓	✓	✓	✓	✓	✓		✓			✓	✓	✓	✓	✓	✓	✓
3Q+1SY	✓	✓	✓	✓	✓	✓	✓	✓	✓	✓	✓		✓			✓	✓	✓	✓	✓	✓	✓
1S51	✓	✓	✓	✓	✓	✓	✓	✓	✓	✓	✓	✓	✓	✓	✓	✓	✓	✓	✓	✓	✓	✓
1S52	✓	✓	✓	✓	✓	✓	✓	✓	✓	✓	✓	✓	✓	✓	✓	✓	✓	✓	✓	✓	✓	✓
400V 2Q	✓	✓	✓	✓	✓	✓	✓	✓	✓	✓	✓	✓	✓	✓	✓	✓	✓	✓	✓	✓	✓	✓
400V 1Q+1SY	✓	✓	✓	✓	✓	✓	✓	✓	✓	✓	✓	✓	✓	✓	✓	✓	✓	✓	✓	✓	✓	✓
AUE	✓	✓						✓		✓	✓	✓	✓	✓	✓	✓	✓	✓	✓	✓	✓	✓
Ekip COM STA RTU/TCP	✓	✓	✓	✓	✓	✓	✓	✓	✓	✓	✓	✓	✓	✓	✓	✓	✓	✓	✓	✓	✓	✓

✓ Compatible

Circuit-breakers with electronic Ekip Touch and Ekip Hi-Touch trip units

	RHD	RHE	CK RHE->RHS	FLD	MOE/MOE-E	PLL on CB	KLC on CB	RHL	MOL on motor	YO/YU 3p	YO/YU 1p	1Q+1SY	2Q+1SY	3Q+1SY	1S51	1S52	400V 2Q	AUE	Ekip COM	Ekip 1K
RHD								✓		✓	✓	✓	✓	✓	✓	✓	✓	✓	✓	✓
RHE			✓					✓		✓	✓	✓	✓	✓	✓	✓	✓	✓	✓	✓
CK RHE->RHS		✓						✓		✓	✓	✓	✓	✓	✓	✓	✓	✓	✓	✓
FLD								✓		✓	✓	✓	✓	✓	✓	✓	✓	✓	✓	✓
MOE/MOE-E									✓	✓	✓	✓	✓	✓	✓	✓	✓	✓	✓	✓
PLL on CB										✓	✓	✓	✓	✓	✓	✓	✓	✓	✓	✓
KLC on CB											✓	✓	✓	✓	✓	✓	✓	✓	✓	✓
RHL	✓	✓	✓	✓						✓	✓	✓	✓	✓	✓	✓	✓	✓	✓	✓
MOL on motor					✓					✓	✓	✓	✓	✓	✓	✓	✓	✓	✓	✓
YO/YU 3p	✓	✓	✓	✓	✓	✓		✓	✓		✓	✓	✓	✓	✓	✓	✓	✓	✓	✓
YO/YU 1p	✓	✓	✓	✓	✓	✓	✓	✓	✓	✓		✓	✓	✓	✓	✓	✓	✓	✓	✓
1Q+1SY	✓	✓	✓	✓	✓	✓	✓	✓	✓	✓	✓				✓	✓	✓	✓	✓	✓
2Q+1SY	✓	✓	✓	✓	✓	✓	✓	✓	✓	✓	✓				✓	✓	✓	✓	✓	✓
3Q+1SY	✓	✓	✓	✓	✓	✓	✓	✓	✓	✓	✓				✓	✓	✓	✓	✓	✓
1S51	✓	✓	✓	✓	✓	✓	✓	✓	✓	✓	✓	✓	✓	✓		✓	✓	✓	✓	✓
1S52	✓	✓	✓	✓	✓	✓		✓	✓	✓	✓	✓	✓	✓	✓		✓	✓	✓	✓
400V 2Q	✓	✓	✓	✓	✓	✓	✓	✓	✓	✓		✓	✓	✓	✓	✓	✓	✓	✓	✓
AUE	✓	✓						✓		✓	✓	✓	✓	✓	✓	✓	✓	✓	✓	✓
Ekip COM	✓	✓	✓	✓	✓	✓	✓	✓	✓	✓	✓	✓	✓	✓	✓	✓	✓	✓	✓	✓
Ekip 1K	✓	✓	✓	✓	✓	✓		✓	✓		✓	✓	✓	✓	✓	✓	✓	✓	✓	✓

✓ Compatible

Compatibility of accessories

Tmax XT6

	RHD	RHE	FLD	MOE/MOE-E	PLL on CB	KLC on CB	RHL	MOL on motor	YU 3p	YO 1p	1Q+1SY	2Q+1SY	3Q+1SY	1S51	1S52
RHD							✓		✓	✓	✓	✓	✓	✓	✓
RHE							✓		✓	✓	✓	✓	✓	✓	✓
FLD							✓		✓	✓	✓	✓	✓	✓	✓
MOE/MOE-E								✓	✓	✓	✓	✓	✓	✓	✓
PLL on CB									✓	✓	✓	✓	✓	✓	✓
KLC on CB										✓	✓	✓	✓	✓	✓
RHL	✓	✓	✓						✓	✓	✓	✓	✓	✓	✓
MOL on motor				✓					✓	✓	✓	✓	✓	✓	✓
YU 3p	✓	✓	✓	✓	✓		✓	✓		✓	✓	✓	✓	✓	✓
YO 1p	✓	✓	✓	✓	✓	✓	✓	✓	✓		✓	✓	✓	✓	✓
1Q+1SY	✓	✓	✓	✓	✓	✓	✓	✓	✓	✓				✓	✓
2Q+1SY	✓	✓	✓	✓	✓	✓	✓	✓	✓	✓				✓	✓
3Q+1SY	✓	✓	✓	✓	✓	✓	✓	✓	✓	✓				✓	✓
1S51	✓	✓	✓	✓	✓	✓	✓	✓	✓	✓	✓	✓	✓		✓
1S52	✓	✓	✓	✓	✓	✓	✓	✓	✓	✓	✓	✓	✓	✓	

✓ Compatible

Tmax XT7

In addition to the accessories listed in the table below, it is always possible to complement the XT7 circuit-breakers with the Ekip Supply module and up to other two modules. Alternatives to the Ekip supply, 24V and CAN modules can be directly connected by using appropriate terminal blocks.

	RHD	RHE	PLC on CB	KLC on CB	RHL	YO	YU / YO2	4Q	1SY	1S51	1S52	AUE
RHD	✓				✓	✓	✓	✓	✓	✓	✓	✓
RHE		✓			✓	✓	✓	✓	✓	✓	✓	✓
PLC on CB			✓			✓	✓	✓	✓	✓	✓	
KLC on CB				✓		✓	✓	✓	✓	✓	✓	
RHL	✓	✓				✓	✓	✓	✓	✓	✓	✓
YO	✓	✓	✓	✓	✓		✓	✓	✓	✓	✓	✓
YU / YO2	✓	✓	✓	✓	✓	✓		✓	✓	✓	✓	✓
4Q	✓	✓	✓	✓	✓	✓	✓		✓	✓	✓	✓
1SY	✓	✓	✓	✓	✓	✓	✓	✓		✓	✓	✓
1S51	✓	✓	✓	✓	✓	✓	✓	✓	✓		✓	✓
1S52	✓	✓	✓	✓	✓	✓	✓	✓	✓	✓		✓
AUE	✓	✓			✓	✓	✓	✓	✓	✓	✓	

✓ Compatible

Tmax XT7 M

In addition to the accessories listed in the table below, it is always possible to complement the XT7 M circuit-breakers with the Ekip Supply module and up to other two modules. Alternatives to the Ekip supply, 24V and CAN modules can be directly connected by using appropriate terminal blocks.

	PLC on CB	KLC on CB	PBC	MOC	YO	YU / YO2	YC	YR	RTC	4Q	1S51	S33M/2	M	Ekip COM act.	RTC Ekip
PLC on CB		✓		✓	✓	✓	✓	✓	✓	✓	✓	✓	✓	✓	✓
KLC on CB	✓		✓	✓	✓	✓	✓	✓	✓	✓	✓	✓	✓	✓	✓
PBC		✓		✓	✓	✓	✓	✓	✓	✓	✓	✓	✓	✓	✓
MOC	✓	✓	✓		✓	✓	✓	✓	✓	✓	✓	✓	✓	✓	✓
YO	✓	✓	✓	✓		✓	✓	✓	✓	✓	✓	✓	✓	✓	✓
YU / YO2	✓	✓	✓	✓	✓		✓	✓	✓	✓	✓	✓	✓	✓	✓
YC	✓	✓	✓	✓	✓	✓		✓	✓	✓	✓	✓	✓	✓	✓
YR	✓	✓	✓	✓	✓	✓	✓		✓	✓	✓	✓	✓	✓	✓
RTC	✓	✓	✓	✓	✓	✓	✓	✓		✓	✓	✓	✓	✓	✓
4Q	✓	✓	✓	✓	✓	✓	✓	✓	✓		✓	✓	✓	✓	✓
1S51	✓	✓	✓	✓	✓	✓	✓	✓	✓	✓		✓	✓	✓	✓
S33M/2	✓	✓	✓	✓	✓	✓	✓	✓	✓	✓	✓		✓	✓	✓
M	✓	✓	✓	✓	✓	✓	✓	✓	✓	✓	✓	✓		✓	✓
Ekip COM act.	✓	✓	✓	✓	✓	✓	✓	✓	✓	✓	✓	✓	✓		✓
RTC Ekip	✓	✓	✓	✓	✓	✓	✓	✓	✓	✓	✓	✓	✓	✓	

✓ Compatible

Compatibility of accessories

Withdrawable versions

Tmax XT2-XT4

	1S51	1Q+1SY	3Q+1SY	3Q+2SY	2Q+2SY+1S51	2Q 400V	1Q+1SY 400V	Ekip COM / Ekip COM STA TCP	Ekip COM STARTU / Ekip COM LSI-LSIG ⁽¹⁾	NE	MOE	MOE-E	AUX-MO	AUE	SOR/UVR 3p	RC Coil 3p	SOR/UVR 4p
1S51		✓							✓	✓	✓	✓	✓	✓	✓	✓	✓
1Q+1SY	✓									✓	✓	✓	✓	✓	✓	✓	✓
3Q+1SY										✓	✓	✓	✓	✓	✓	✓	✓
3Q+2SY											✓	✓	✓	✓	✓	✓	✓
2Q+2SY+1S51											✓	✓	✓	✓	✓	✓	✓
2Q 400V										✓	✓	✓	✓	✓	✓	✓	✓
1Q+1SY 400V										✓	✓	✓	✓	✓	✓	✓	✓
Ekip COM / Ekip COM STA TCP										✓	✓	✓	✓	✓	✓	✓	✓
Ekip COM STA RTU / Ekip COM LSI-LSIG ⁽¹⁾	✓									✓	✓	✓	✓	✓	✓	✓	✓
NE	✓	✓	✓			✓	✓	✓	✓		✓	✓	✓	✓	✓	✓	✓
MOE	✓	✓	✓	✓	✓	✓	✓	✓	✓	✓			✓		✓	✓	✓
MOE-E	✓	✓	✓	✓	✓	✓	✓	✓	✓	✓			✓		✓	✓	✓
AUX-MO	✓	✓	✓	✓	✓	✓	✓	✓	✓	✓	✓	✓			✓	✓	
AUE	✓	✓	✓	✓	✓	✓	✓	✓	✓	✓					✓	✓	✓
SOR/UVR 3p	✓	✓	✓	✓	✓	✓	✓	✓	✓	✓	✓	✓	✓	✓			✓
RC Coil 3p	✓	✓	✓	✓	✓	✓	✓	✓	✓	✓	✓	✓	✓	✓			✓
SOR/UVR 4p	✓	✓	✓	✓	✓	✓	✓	✓	✓	✓	✓	✓		✓	✓	✓	

✓ Compatible

(1) Ekip COM LSI-LSIG is only available with Ekip LSI and LSIG trip units

With the Ekip Touch and Hi-Touch trip units there is always an additional connector for 24V and CAN modules to be mounted on the left side of the moving part.

Tmax XT5

	1S52	1S51	1Q+1SY	2Q+1SY	3Q+1SY	2Q 400V	1Q+1SY 400V	Ekip COM	Ekip COM STARTU	Ekip COM STATCP	MOE	MOE-E	AUE	YO/YU 3p	YO/YU 1p	Ekip 1K
1S52		✓	✓	✓	✓	✓					✓	✓	✓	✓	✓	
1S51	✓		✓	✓	✓	✓	✓	✓	✓	✓	✓	✓	✓	✓	✓	✓
1Q+1SY	✓	✓				✓	✓	✓ ⁽¹⁾		✓	✓	✓	✓	✓	✓	✓
2Q+1SY	✓	✓					✓	✓ ⁽¹⁾		✓	✓	✓	✓	✓	✓	✓
3Q+1SY	✓	✓					✓	✓ ⁽¹⁾		✓	✓	✓	✓	✓	✓	✓
2Q 400V	✓	✓	✓				✓	✓	✓	✓	✓	✓	✓	✓		
1Q+1SY 400V		✓	✓	✓	✓	✓					✓	✓	✓		✓	
Ekip COM		✓	✓ ⁽¹⁾	✓ ⁽¹⁾	✓ ⁽¹⁾	✓					✓	✓	✓		✓	✓
Ekip COM STA RTU		✓				✓					✓	✓	✓		✓	✓
Ekip COM STA TCP		✓	✓	✓	✓	✓					✓	✓	✓	✓	✓	✓
MOE	✓	✓	✓	✓	✓	✓	✓	✓	✓	✓				✓	✓	✓
MOE-E	✓	✓	✓	✓	✓	✓	✓	✓	✓	✓				✓	✓	✓
AUE	✓	✓	✓	✓	✓	✓	✓	✓	✓	✓				✓	✓	✓
YO/YU 3p	✓	✓	✓	✓	✓	✓					✓	✓	✓		✓	✓
YO/YU 1p	✓	✓	✓	✓	✓		✓	✓	✓	✓	✓	✓	✓	✓		✓
Ekip 1K		✓	✓					✓	✓	✓	✓	✓	✓		✓	

✓ Compatible

(1) In case of the Ekip COM Modbus, RTU, the tick must be disregarded.

Tmax XT6

	1S52	1S51	1Q+1SY	2Q+1SY	3Q+1SY	MOE	MOE-E	YU 3p	YO 1p
1S52		✓	✓	✓	✓	✓	✓		✓
1S51	✓		✓	✓	✓	✓	✓	✓	✓
1Q+1SY	✓	✓				✓	✓	✓	✓
2Q+1SY	✓	✓				✓	✓	✓	✓
3Q+1SY	✓	✓				✓	✓	✓	✓
MOE	✓	✓	✓	✓	✓			✓	✓
MOE-E	✓	✓	✓	✓	✓			✓	✓
YU 3p		✓	✓	✓	✓	✓	✓		✓
YO 1p	✓	✓	✓	✓	✓	✓	✓	✓	

✓ Compatible

Compatibility of accessories

Position of internal accessories for the Tmax XT1

Tmax XT1

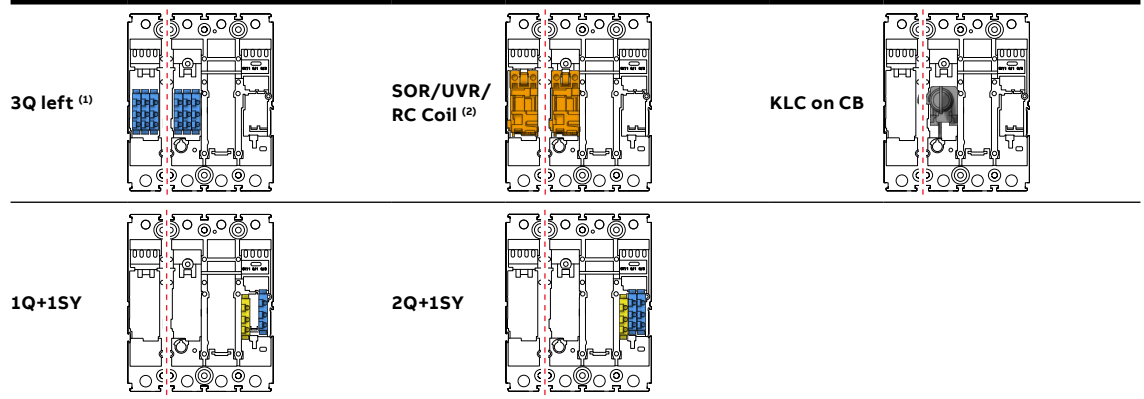

- (1) For 4-pole version, 3Q left on the fourth pole only.
 (2) RC Coil on the third pole only.

Position of internal accessories for the Tmax XT3

Tmax XT3

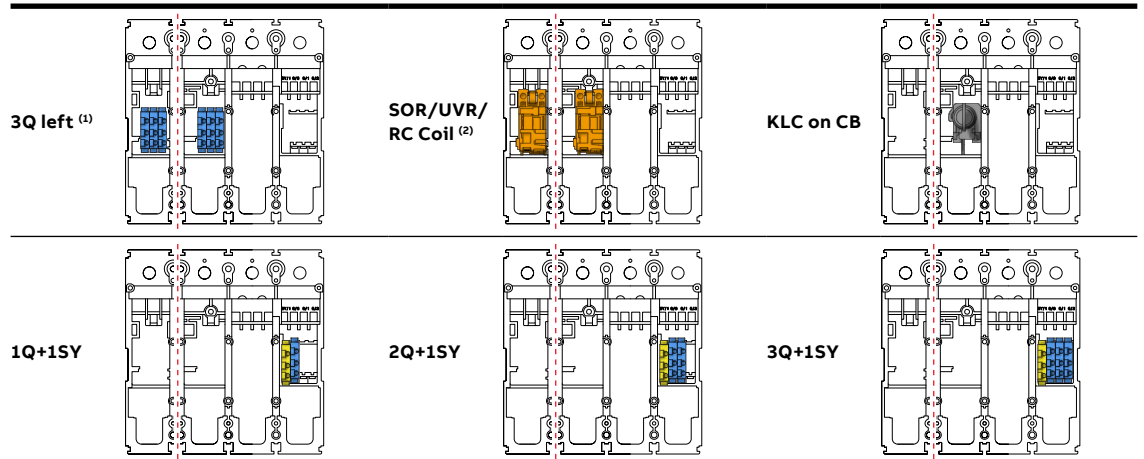

- (1) For 4-pole version, 3Q left on the fourth pole only.
 (2) RC Coil on the third pole only.

Position of internal accessories for the Tmax XT2-XT4

Tmax XT2-XT4

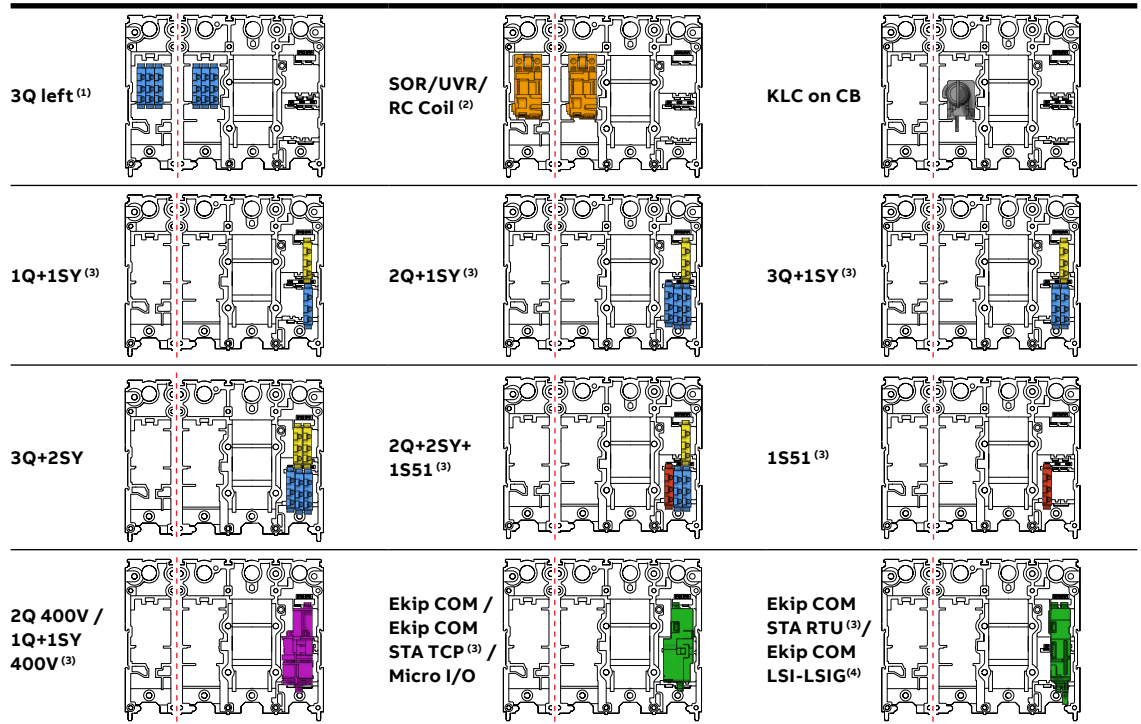

(1) For 4-pole version, 3Q left on the fourth pole only.

(2) RC Coil on the third pole only.

(3) Not available for the Ekip Touch and Hi-Touch trip units.

(4) Available only on Ekip LSI and Ekip LSIg.

Compatibility of accessories

Position of internal accessories for the Tmax XT5

Tmax XT5

With 4-pole circuit-breakers, it is not possible to add accessories to the fourth pole.

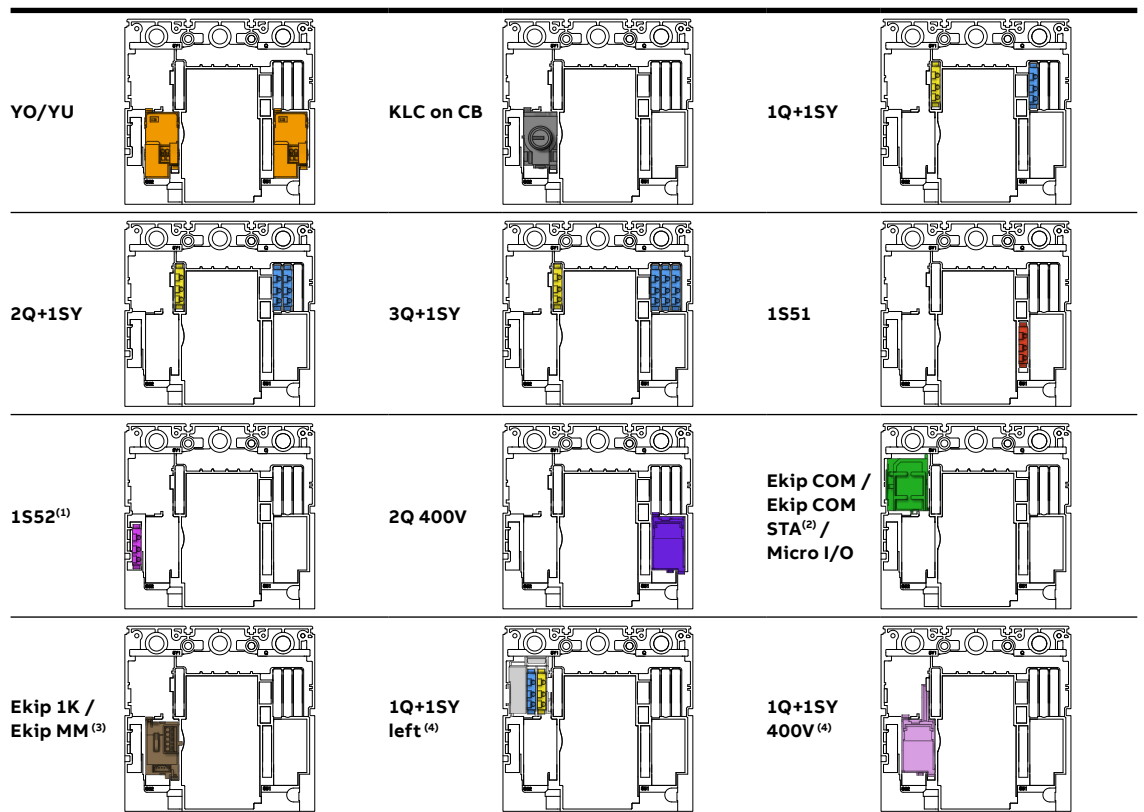

(1) YO or YU must be mounted on the third pole to make S52 signaling available.

(2) Ekip COM or stand-alone module, depending on the trip unit.

(3) Available for the Ekip Touch and Ekip Hi-Touch only.

(4) Available for the TM trip unit, Ekip Dip trip unit and switch-disconnector only.

Position of internal accessories for the Tmax XT6

Tmax XT6

With 4-pole circuit-breakers, it is not possible to add accessories to the fourth pole.

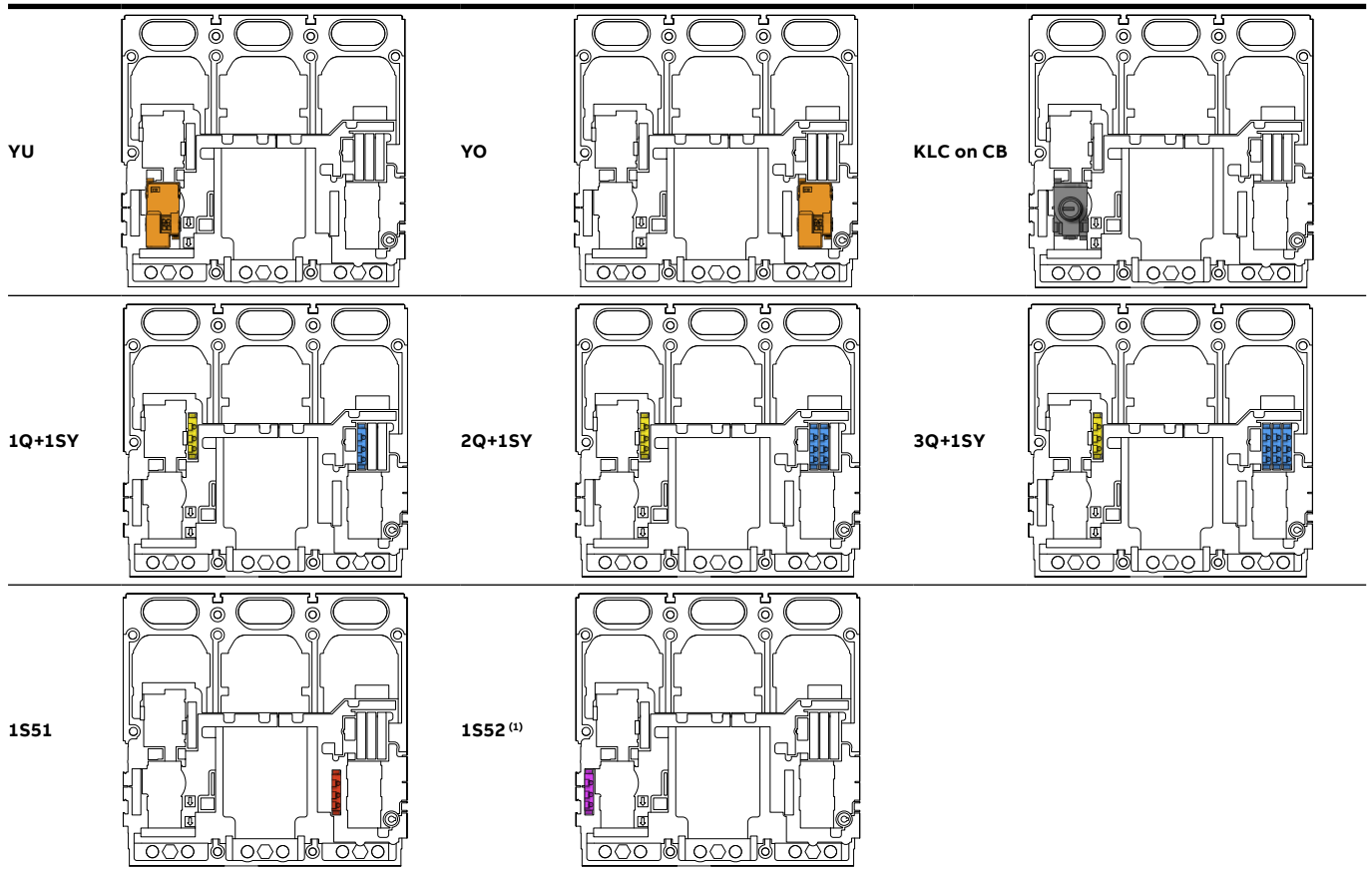

(1) The YO or YU must be mounted on the third pole to make S52 signaling available.

Compatibility of accessories

Position of internal accessories for the Tmax XT7

Tmax XT7

All internal accessories for the XT7 can be mounted at the same time without any restriction concerning their compatibility. To guarantee proper operation of all accessories, please refer to the relevant tables (see previous pages).

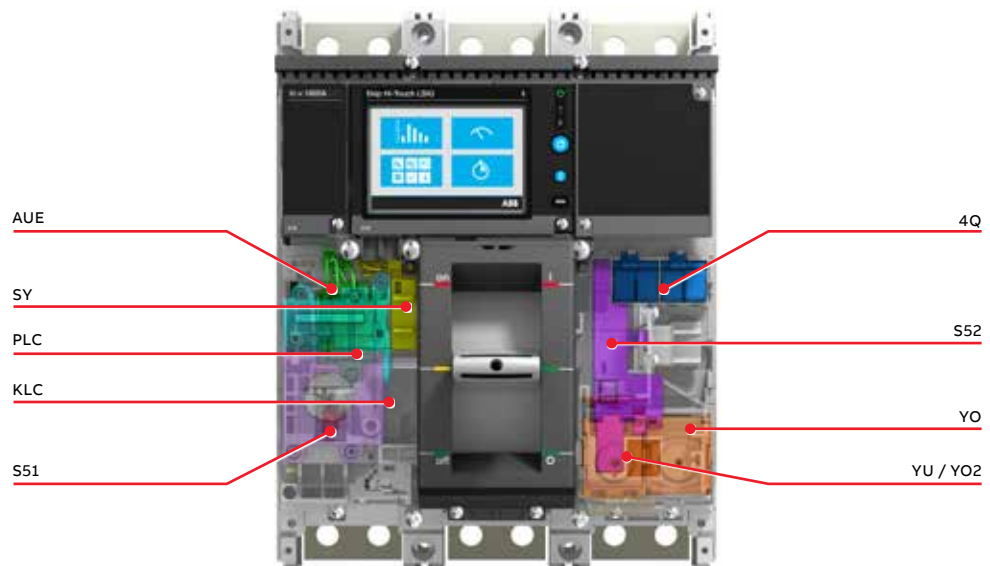

Position of internal accessories for the Tmax XT7 M

Tmax XT7 M

All internal accessories for the XT7 M can be mounted at the same time without any restriction concerning their compatibility. To guarantee proper operation of all accessories, please refer to the relevant tables (see previous pages).

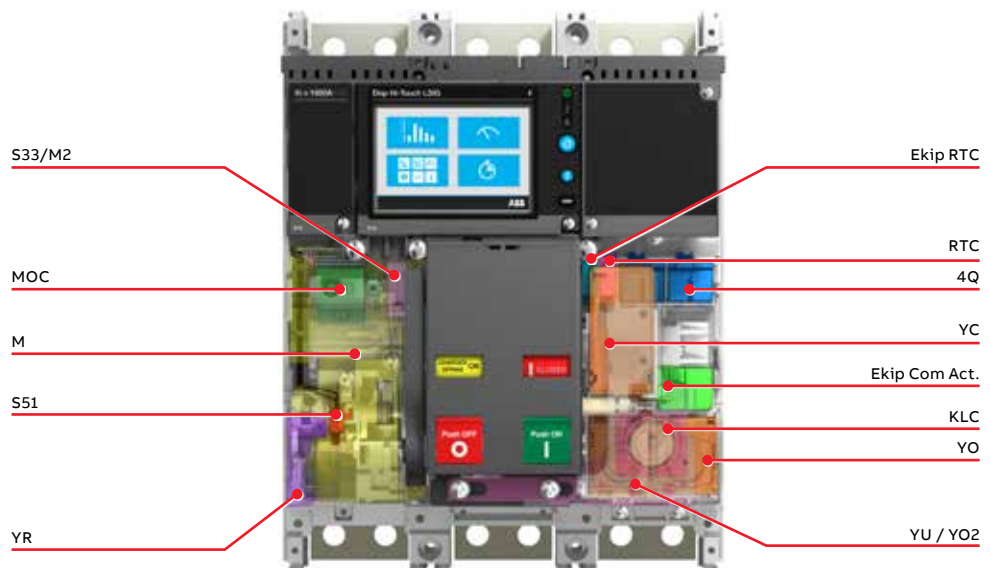

Compatibility of accessories

Reading information

Glossary

RHD	= Direct rotary handle	S51	= Contact signaling tripping due to trip unit
RHE	= Transmitted rotary handle		
RHS	= Lateral transmitted rotary handle	S52	= Contact signaling YO/YU tripping
CK RHE->RHS	= Conversion kit for converting an RHE into an RHS	S33M/2	= Contact signaling loaded springs
FLD	= Front for lever operating mechanism	AUE	= Early auxiliary contacts
MOD	= Direct action motor operator	RTC	= Ready to close signaling contact
MOE/MOE-E	= Stored energy motor operator	PBC	= Protection device for opening and closing pushbuttons
M	= Motor operator	MOC	= Mechanical operation counter
PLL on CB	= Padlock device on circuit-breaker	NE	= Neutral external
KLC on CB	= Keylock device on circuit-breaker	AUX-MO	= Auxiliary contacts for stored energy motor operator
RHL	= Keylock for rotary handle and front for lever operating mechanism	Micro I/O	= Module for Touch and Hi-Touch trip unit
MOL on motor	= Keylock for motor operator	Ekip COM STA	= Communication module stand-alone
SOR	= Shunt opening release	Ekip COM STA RTU	= Communication module stand-alone Modbus RTU
UVR	= Undervoltage release	Ekip COM STA TCP	= Communication module stand-alone Modbus TCP
YO	= Shunt opening release	Ekip COM	= Communication module
YU	= Undervoltage release	Ekip COM act.	= Ekip COM actuator
YC	= Closing release	Ekip 1K	= Ekip 1K signaling
YR	= Remote resetting	Ekip MM	= Ekip Maintenance Module
RC Coil	= Coil for residual current device	Ekip COM LSI-LSIG	= Communication module for Ekip LSI and LSIg XT2-XT4
Q	= Contact signaling open/closed		
SY	= Contact signaling tripping		

Ordering codes

- Ordering codes for XT1**
- 8/3 Automatic circuit-breakers
 - 8/6 Switch-disconnectors
- Ordering codes for XT2**
- 8/7 Automatic circuit-breakers
 - 8/22 Breaking part
 - 8/23 Trip units
 - 8/25 Breaking part + trip unit solution
- Ordering codes for XT3**
- 8/26 Automatic circuit-breakers
 - 8/28 Switch-disconnectors
- Ordering codes for XT4**
- 8/29 Automatic circuit-breakers
 - 8/44 Switch-disconnectors
 - 8/45 Breaking part
 - 8/46 Trip units
 - 8/49 Breaking part + trip unit solution
- Ordering codes for XT5**
- 8/50 Automatic circuit-breakers
 - 8/62 Switch-disconnectors
 - 8/63 Breaking part
 - 8/64 Trip units
 - 8/66 Breaking part + trip unit solution
- Ordering codes for XT6**
- 8/67 Automatic circuit-breakers
 - 8/70 Switch-disconnectors
 - 8/71 Breaking part
 - 8/72 Trip units
 - 8/73 Breaking part + trip unit solution
- Ordering codes for XT7/XT7 M**
- 8/74 Automatic circuit-breakers – XT7
 - 8/86 Automatic circuit-breakers – XT7 M
 - 8/98 Switch-disconnectors – XT7/XT7 M
 - 8/99 Trip units – XT7/XT7 M
- Ordering codes for accessories**
- 8/100 Execution and installation
 - 8/100 Fixed parts
 - 8/101 Conversion kits
 - 8/102 Plug and socket adapters
 - 8/102 Bracket for fixing on DIN-rail
 - 8/102 Floor fixing plate
 - 8/102 Cable rack
 - 8/103 Power connection
 - 8/103 Terminals for circuit-breaker
 - 8/105 Terminals for fixed part
 - 8/105 Fixed part adapters

8/106	Signaling
8/106	Auxiliary contacts - AUX
8/109	Auxiliary position contacts – AUP
8/109	Early auxiliary contacts – AUE
8/110	Operating mechanism
8/110	Rotary handle operating mechanism
8/112	Front for operating lever mechanism - FLD
8/113	Remote control
8/113	Shunt opening release
8/114	Undervoltage release
8/117	Delay device for undervoltage release - UVD
8/117	Connectors for shunt opening and undervoltage release for withdrawable version
8/118	Resetting remotely - YR
8/118	Motor operator
8/120	Safety and protection
8/120	Terminals covers and phase separators
8/122	IP Protections
8/122	MOC
8/123	Keylocks and padlocks
8/128	Flanges
8/129	Interlocks and switching devices
8/129	Automatic transfer devices
8/130	Residual current devices
8/131	Accessories for electronic Ekip LSI, Ekip LSIg and Ekip M-LRIU trip units
8/132	Accessories for electronic Ekip Touch trip units
8/132	Ekip cartridge
8/132	Power supply modules
8/132	Connectivity modules
8/134	Signaling modules
8/134	Other modules
8/136	Advanced functionality
8/137	Displaying and supervision systems
8/138	Other accessories for trip units
8/138	Test and configuration
8/138	Current sensors
8/139	Rating plug for Ekip trip units

Ordering codes for XT1

Automatic circuit-breakers

Distribution circuit-breakers



XT1 - circuit-breaker

SACE XT1B (18kA) TMD - Front terminals (F)

Size	lu	Trip units	In	Type	3 poles	4 poles
					Code	Code
XT1	160	TMD	16	XT1B 160 TMD 16-450	1SDA066799R1	1SDA066810R1
			20	XT1B 160 TMD 20-450	1SDA066800R1	1SDA066811R1
			25	XT1B 160 TMD 25-450	1SDA066801R1	1SDA066812R1
			32	XT1B 160 TMD 32-450	1SDA066802R1	1SDA066813R1
			40	XT1B 160 TMD 40-450	1SDA066803R1	1SDA066814R1
			50	XT1B 160 TMD 50-500	1SDA066804R1	1SDA066815R1
			63	XT1B 160 TMD 63-630	1SDA066805R1	1SDA066816R1
			80	XT1B 160 TMD 80-800	1SDA066806R1	1SDA066817R1
			100	XT1B 160 TMD 100-1000	1SDA066807R1	1SDA066818R1
			125	XT1B 160 TMD 125-1250	1SDA066808R1	1SDA066821R1
			160	XT1B 160 TMD 160-1600	1SDA066809R1	1SDA066888R1
			125	XT1B 160 TMD 125-1250 InN=50%		1SDA066819R1
			160	XT1B 160 TMD 160-1600 InN=50%		1SDA066820R1

SACE XT1C (25kA) TMD - Front terminals (F)

Size	lu	Trip units	In	Type	3 poles	4 poles
					Code	Code
XT1	160	TMD	16	XT1C 160 TMD 16-450	1SDA080825R1	1SDA080840R1
			20	XT1C 160 TMD 20-450	1SDA080826R1	1SDA080841R1
			25	XT1C 160 TMD 25-450	1SDA067391R1	1SDA067400R1
			32	XT1C 160 TMD 32-450	1SDA067392R1	1SDA067401R1
			40	XT1C 160 TMD 40-450	1SDA067393R1	1SDA067402R1
			50	XT1C 160 TMD 50-500	1SDA067394R1	1SDA067403R1
			63	XT1C 160 TMD 63-630	1SDA067395R1	1SDA067404R1
			80	XT1C 160 TMD 80-800	1SDA067396R1	1SDA067405R1
			100	XT1C 160 TMD 100-1000	1SDA067397R1	1SDA067406R1
			125	XT1C 160 TMD 125-1250	1SDA067398R1	1SDA067409R1
			160	XT1C 160 TMD 160-1600	1SDA067399R1	1SDA067410R1
			125	XT1C 160 TMD 125-1250 InN=50%		1SDA067407R1
			160	XT1C 160 TMD 160-1600 InN=50%		1SDA067408R1

Ordering codes for XT1

Automatic circuit-breakers



—
XT1 - circuit-breaker

SACE XT1N (36kA) TMF/TMD - Front terminals (F)

Size	Iu	Trip units	In	Type	3 poles	4 poles
					Code	Code
XT1	160	TMF	16	XT1N 160 TMF 16-450	1SDA080827R1	1SDA080842R1
			20	XT1N 160 TMF 20-450	1SDA080828R1	1SDA080843R1
XT1	160	TMD	25	XT1N 160 TMD 25-450	1SDA080829R1	1SDA080844R1
			32	XT1N 160 TMD 32-450	1SDA067411R1	1SDA067419R1
			40	XT1N 160 TMD 40-450	1SDA067412R1	1SDA067420R1
			50	XT1N 160 TMD 50-500	1SDA067413R1	1SDA067421R1
			63	XT1N 160 TMD 63-630	1SDA067414R1	1SDA067422R1
			80	XT1N 160 TMD 80-800	1SDA067415R1	1SDA067423R1
			100	XT1N 160 TMD 100-1000	1SDA067416R1	1SDA067424R1
			125	XT1N 160 TMD 125-1250	1SDA067417R1	1SDA067427R1
			160	XT1N 160 TMD 160-1600	1SDA067418R1	1SDA067428R1
			125	XT1N 160 TMD 125-1250 InN=50%		1SDA067425R1
160	XT1N 160 TMD 160-1600 InN=50%		1SDA067426R1			

Distribution circuit-breakers

SACE XT1S (50kA) TMF/TMD - Front terminals (F)



—
XT1 - circuit-breaker

Size	lu	Trip units	In	Type	3 poles	4 poles
					Code	Code
XT1	160	TMF	16	XT1S 160 TMF 16-450	1SDA080830R1	1SDA080845R1
			20	XT1S 160 TMF 20-450	1SDA080831R1	1SDA080846R1
XT1	160	TMD	25	XT1S 160 TMD 25-450	1SDA080832R1	1SDA080847R1
			32	XT1S 160 TMD 32-450	1SDA080833R1	1SDA080848R1
			40	XT1S 160 TMD 40-450	1SDA080834R1	1SDA080849R1
			50	XT1S 160 TMD 50-500	1SDA067431R1	1SDA067439R1
			63	XT1S 160 TMD 63-630	1SDA067432R1	1SDA067440R1
			80	XT1S 160 TMD 80-800	1SDA067433R1	1SDA067441R1
			100	XT1S 160 TMD 100-1000	1SDA067434R1	1SDA067442R1
			125	XT1S 160 TMD 125-1250	1SDA067435R1	1SDA067445R1
			160	XT1S 160 TMD 160-1600	1SDA067436R1	1SDA067446R1
			125	XT1S 160 TMD 125-1250 InN=50%		1SDA067443R1
160	XT1S 160 TMD 160-1600 InN=50%		1SDA067444R1			

Distribution circuit-breakers

SACE XT1H (70kA) TMF/TMD - Front terminals (F)



—
XT1 - circuit-breaker

Size	lu	Trip units	In	Type	3 poles	4 poles
					Code	Code
XT1	160	TMF	16	XT1H 160 TMF 16-450	1SDA080835R1	1SDA080850R1
			20	XT1H 160 TMF 20-450	1SDA080836R1	1SDA080851R1
XT1	160	TMD	25	XT1H 160 TMD 25-450	1SDA080837R1	1SDA080852R1
			32	XT1H 160 TMD 32-450	1SDA080838R1	1SDA080853R1
			40	XT1H 160 TMD 40-450	1SDA080839R1	1SDA080854R1
			50	XT1H 160 TMD 50-500	1SDA067449R1	1SDA067457R1
			63	XT1H 160 TMD 63-630	1SDA067450R1	1SDA067458R1
			80	XT1H 160 TMD 80-800	1SDA067451R1	1SDA067459R1
			100	XT1H 160 TMD 100-1000	1SDA067452R1	1SDA067460R1
			125	XT1H 160 TMD 125-1250	1SDA067453R1	1SDA067463R1
			160	XT1H 160 TMD 160-1600	1SDA067454R1	1SDA067464R1
			125	XT1H 160 TMD 125-1250 InN=50%		1SDA067461R1
160	XT1H 160 TMD 160-1600 InN=50%		1SDA067462R1			

Ordering codes for XT1

Switch-disconnectors



—
XT1 -
switch-disconnector

SACE XT1D - Switch-disconnectors

Size	lu	Type	3 poles	4 poles
			Code	Code
XT1	160	XT1D 160	1SDA068208R1	1SDA068209R1

Ordering codes for XT2

Automatic circuit-breakers

Distribution circuit-breakers

SACE XT2N (36 kA) TMD/TMA - Front terminals (F)



XT2 - circuit-breaker

Size	lu	Trip units	In	Type	3 poles	4 poles
					Code	Code
XT2 160	TMD		1.6	XT2N 160 TMD 1,6-16	1SDA067000R1	1SDA067021R1
			2	XT2N 160 TMD 2-20	1SDA067001R1	1SDA067022R1
			2.5	XT2N 160 TMD 2,5-25	1SDA067002R1	1SDA067023R1
			3.2	XT2N 160 TMD 3,2-32	1SDA067003R1	1SDA067024R1
			4	XT2N 160 TMD 4-40	1SDA067004R1	1SDA067025R1
			5	XT2N 160 TMD 5-50	1SDA067005R1	1SDA067026R1
			6.3	XT2N 160 TMD 6,3-63	1SDA067006R1	1SDA067027R1
			8	XT2N 160 TMD 8-80	1SDA067007R1	1SDA067028R1
			10	XT2N 160 TMD 10-100	1SDA067008R1	1SDA067029R1
			12.5	XT2N 160 TMD 12,5-125	1SDA067009R1	1SDA067030R1
			16	XT2N 160 TMD 16-300	1SDA067010R1	1SDA067031R1
			20	XT2N 160 TMD 20-300	1SDA067011R1	1SDA067032R1
			25	XT2N 160 TMD 25-300	1SDA067012R1	1SDA067033R1
			32	XT2N 160 TMD 32-320	1SDA067013R1	1SDA067034R1
			XT2 160	TMA		40
50	XT2N 160 TMA 50-500	1SDA067015R1				1SDA067036R1
63	XT2N 160 TMA 63-630	1SDA067016R1				1SDA067037R1
80	XT2N 160 TMA 80-800	1SDA067017R1				1SDA067038R1
100	XT2N 160 TMA 100-1000	1SDA067018R1				1SDA067039R1
125	XT2N 160 TMA 125-1250	1SDA067019R1				1SDA067042R1
160	XT2N 160 TMA 160-1600	1SDA067020R1				1SDA067043R1
125	XT2N 160 TMA 125-1250 InN=50%					1SDA067040R1
160	XT2N 160 TMA 160-1600 InN=50%		1SDA067041R1			

SACE XT2N (36 kA) Ekip LS/I - Front terminals (F)

Size	lu	Trip units	In	Type	3 poles	4 poles
					Code	Code
XT2 160	Ekip LS/I		10	XT2N 160 Ekip LS/I In=10A	1SDA067054R1	1SDA067090R1
			25	XT2N 160 Ekip LS/I In=25A	1SDA067055R1	1SDA067091R1
			63	XT2N 160 Ekip LS/I In=63A	1SDA067056R1	1SDA067092R1
			100	XT2N 160 Ekip LS/I In=100A	1SDA067057R1	1SDA067093R1
			160	XT2N 160 Ekip LS/I In=160A	1SDA067058R1	1SDA067095R1

SACE XT2N (36 kA) Ekip I - Front terminals (F)

Size	lu	Trip units	In	Type	3 poles	4 poles
					Code	Code
XT2 160	Ekip I		10	XT2N 160 Ekip I In=10A	1SDA067059R1	1SDA067096R1
			25	XT2N 160 Ekip I In=25A	1SDA067060R1	1SDA067097R1
			63	XT2N 160 Ekip I In=63A	1SDA067061R1	1SDA067098R1
			100	XT2N 160 Ekip I In=100A	1SDA067062R1	1SDA067099R1
			160	XT2N 160 Ekip I In=160A	1SDA067063R1	1SDA067101R1

Ordering codes for XT2

Automatic circuit-breakers



XT2 - circuit-breaker

SACE XT2N (36 kA) Ekip LSI - Front terminals (F)

Size	lu	Trip units	In	Type	3 poles	4 poles
					Code	Code
XT2	160	Ekip LSI	10	XT2N 160 Ekip LSI In=10A	1SDA067067R1	1SDA067102R1
			25	XT2N 160 Ekip LSI In=25A	1SDA067068R1	1SDA067103R1
			63	XT2N 160 Ekip LSI In=63A	1SDA067069R1	1SDA067104R1
			100	XT2N 160 Ekip LSI In=100A	1SDA067070R1	1SDA067105R1
			160	XT2N 160 Ekip LSI In=160A	1SDA067071R1	1SDA067107R1

SACE XT2N (36 kA) Ekip LSIG - Front terminals (F)

Size	lu	Trip units	In	Type	3 poles	4 poles
					Code	Code
XT2	160	Ekip LSIG	10	XT2N 160 Ekip LSIG In=10A	1SDA067072R1	1SDA067108R1
			25	XT2N 160 Ekip LSIG In=25A	1SDA067073R1	1SDA067109R1
			63	XT2N 160 Ekip LSIG In=63A	1SDA067074R1	1SDA067110R1
			100	XT2N 160 Ekip LSIG In=100A	1SDA067075R1	1SDA067111R1
			160	XT2N 160 Ekip LSIG In=160A	1SDA067076R1	1SDA100024R1

SACE XT2N (36 kA) Ekip Dip LIG - Front terminals (F)

Size	lu	Trip units	In	Type	3 poles	4 poles
					Code	Code
XT2	160	Ekip Dip LIG	10	XT2N 160 Ekip Dip LIG In=10A	1SDA100010R1	1SDA100025R1
			25	XT2N 160 Ekip Dip LIG In=25A	1SDA100011R1	1SDA100026R1
			63	XT2N 160 Ekip Dip LIG In=63A	1SDA100012R1	1SDA100027R1
			100	XT2N 160 Ekip Dip LIG In=100A	1SDA100013R1	1SDA100028R1
			160	XT2N 160 Ekip Dip LIG In=160A	1SDA100014R1	1SDA100029R1

Motor protection circuit-breakers

SACE XT2N (36 kA) MF/MA - Front terminals (F)



XT2 - circuit-breaker

Size	I _n	Trip units	I _n	Type	3 poles	4 poles
					Code	Code
XT2 160	MF		1	XT2N 160 MF 1 I _m =14	1SDA067044R1	
			2	XT2N 160 MF 2 I _m =28	1SDA067045R1	
			4	XT2N 160 MF 4 I _m =56	1SDA067046R1	
			8.5	XT2N 160 MF 8,5 I _m =120	1SDA067047R1	
			12.5	XT2N 160 MF 12,5 I _m =175	1SDA067048R1	
XT2 160	MA		20	XT2N 160 MA 20 I _m =120...280	1SDA067049R1	
			32	XT2N 160 MA 32 I _m =192...448	1SDA067050R1	
			52	XT2N 160 MA 52 I _m =314...728	1SDA067051R1	
			80	XT2N 160 MA 80 I _m =480...1120	1SDA067052R1	
			100	XT2N 160 MA 100 I _m =600...1400	1SDA067053R1	
			160	XT2N 160 MA 160 I _m =960...2240	1SDA0676529R1	

Ordering codes for XT2

Automatic circuit-breakers

Generator protection circuit-breakers

SACE XT2N (36 kA) TMG - Front terminals (F)



—
XT2 - circuit-breaker

Size	lu	Trip units	In	Type	3 poles	4 poles
					Code	Code
XT2	160	TMG	16	XT2N 160 TMG 16-160	1SDA067716R1	1SDA067727R1
			20	XT2N 160 TMG 20-160	1SDA067717R1	1SDA067728R1
			25	XT2N 160 TMG 25-160	1SDA067718R1	1SDA067729R1
			32	XT2N 160 TMG 32-160	1SDA067719R1	1SDA067730R1
			40	XT2N 160 TMG 40-200	1SDA067720R1	1SDA067731R1
			50	XT2N 160 TMG 50-200	1SDA067721R1	1SDA067732R1
			63	XT2N 160 TMG 63-200	1SDA067722R1	1SDA067733R1
			80	XT2N 160 TMG 80-240	1SDA067723R1	1SDA067734R1
			100	XT2N 160 TMG 100-300	1SDA067724R1	1SDA067735R1
			125	XT2N 160 TMG 125-375	1SDA067725R1	1SDA067736R1
			160	XT2N 160 TMG 160-480	1SDA067726R1	1SDA067737R1

Distribution circuit-breakers

SACE XT2S (50 kA) TMD/TMA - Front terminals (F)



—
XT2 - circuit-breaker

Size	lu	Trip units	In	Type	3 poles	4 poles
					Code	Code
XT2	160	TMD	1.6	XT2S 160 TMD 1,6-16	1SDA067540R1	1SDA067561R1
			2	XT2S 160 TMD 2-20	1SDA067541R1	1SDA067562R1
			2.5	XT2S 160 TMD 2,5-25	1SDA067542R1	1SDA067563R1
			3.2	XT2S 160 TMD 3,2-32	1SDA067543R1	1SDA067564R1
			4	XT2S 160 TMD 4-40	1SDA067544R1	1SDA067565R1
			5	XT2S 160 TMD 5-50	1SDA067545R1	1SDA067566R1
			6.3	XT2S 160 TMD 6,3-63	1SDA067546R1	1SDA067567R1
			8	XT2S 160 TMD 8-80	1SDA067547R1	1SDA067568R1
			10	XT2S 160 TMD 10-100	1SDA067548R1	1SDA067569R1
			12.5	XT2S 160 TMD 12,5-125	1SDA067549R1	1SDA067570R1
			16	XT2S 160 TMD 16-300	1SDA067550R1	1SDA067571R1
			20	XT2S 160 TMD 20-300	1SDA067551R1	1SDA067572R1
			25	XT2S 160 TMD 25-300	1SDA067552R1	1SDA067573R1
			32	XT2S 160 TMD 32-320	1SDA067553R1	1SDA067574R1
			XT2	160	TMA	40
50	XT2S 160 TMA 50-500	1SDA067555R1				1SDA067576R1
63	XT2S 160 TMA 63-630	1SDA067556R1				1SDA067577R1
80	XT2S 160 TMA 80-800	1SDA067557R1				1SDA067578R1
100	XT2S 160 TMA 100-1000	1SDA067558R1				1SDA067579R1
125	XT2S 160 TMA 125-1250	1SDA067559R1				1SDA067582R1
160	XT2S 160 TMA 160-1600	1SDA067560R1				1SDA067583R1
125	XT2S 160 TMA 125-1250 InN=50%					1SDA067580R1
160	XT2S 160 TMA 160-1600 InN=50%		1SDA067581R1			

—
XT2 - circuit-breaker**SACE XT2S (50 kA) Ekip LS/I - Front terminals (F)**

Size	lu	Trip units	In	Type	3 poles	4 poles
					Code	Code
XT2	160	Ekip LS/I	10	XT2S 160 Ekip LS/I In=10A	1SDA067800R1	1SDA067833R1
			25	XT2S 160 Ekip LS/I In=25A	1SDA067801R1	1SDA067834R1
			63	XT2S 160 Ekip LS/I In=63A	1SDA067802R1	1SDA067835R1
			100	XT2S 160 Ekip LS/I In=100A	1SDA067803R1	1SDA067836R1
			160	XT2S 160 Ekip LS/I In=160A	1SDA067804R1	1SDA067838R1

SACE XT2S (50 kA) Ekip I - Front terminals (F)

Size	lu	Trip units	In	Type	3 poles	4 poles
					Code	Code
XT2	160	Ekip I	10	XT2S 160 Ekip I In=10A	1SDA067805R1	1SDA067839R1
			25	XT2S 160 Ekip I In=25A	1SDA067806R1	1SDA067840R1
			63	XT2S 160 Ekip I In=63A	1SDA067807R1	1SDA067841R1
			100	XT2S 160 Ekip I In=100A	1SDA067808R1	1SDA067842R1
			160	XT2S 160 Ekip I In=160A	1SDA067809R1	1SDA067844R1

SACE XT2S (50 kA) Ekip LSI - Front terminals (F)

Size	lu	Trip units	In	Type	3 poles	4 poles
					Code	Code
XT2	160	Ekip LSI	10	XT2S 160 Ekip LSI In=10A	1SDA067810R1	1SDA067845R1
			25	XT2S 160 Ekip LSI In=25A	1SDA067811R1	1SDA067846R1
			63	XT2S 160 Ekip LSI In=63A	1SDA067812R1	1SDA067847R1
			100	XT2S 160 Ekip LSI In=100A	1SDA067813R1	1SDA067848R1
			160	XT2S 160 Ekip LSI In=160A	1SDA067814R1	1SDA067850R1

SACE XT2S (50 kA) Ekip LSIg - Front terminals (F)

Size	lu	Trip units	In	Type	3 poles	4 poles
					Code	Code
XT2	160	Ekip LSIg	10	XT2S 160 Ekip LSIg In=10A	1SDA067815R1	1SDA067851R1
			25	XT2S 160 Ekip LSIg In=25A	1SDA067816R1	1SDA067852R1
			63	XT2S 160 Ekip LSIg In=63A	1SDA067817R1	1SDA067853R1
			100	XT2S 160 Ekip LSIg In=100A	1SDA067818R1	1SDA067854R1
			160	XT2S 160 Ekip LSIg In=160A	1SDA067819R1	1SDA067856R1

SACE XT2S (50 kA) Ekip Dip LIG - Front terminals (F)

Size	lu	Trip units	In	Type	3 poles	4 poles
					Code	Code
XT2	160	Ekip Dip LIG	10	XT2S 160 Ekip Dip LIG In=10A	1SDA100040R1	1SDA100055R1
			25	XT2S 160 Ekip Dip LIG In=25A	1SDA100041R1	1SDA100056R1
			63	XT2S 160 Ekip Dip LIG In=63A	1SDA100042R1	1SDA100057R1
			100	XT2S 160 Ekip Dip LIG In=100A	1SDA100043R1	1SDA100058R1
			160	XT2S 160 Ekip Dip LIG In=160A	1SDA100044R1	1SDA100059R1

Ordering codes for XT2

Automatic circuit-breakers

Motor protection circuit-breakers

SACE XT2S (50 kA) MF/MA - Front terminals (F)



XT2 - circuit-breaker

Size	lu	Trip units	In	Type	3 poles	4 poles
					Code	Code
XT2	160	MF	1	XT2S 160 MF 1 Im=14	1SDA067760R1	
			2	XT2S 160 MF 2 Im=28	1SDA067761R1	
			4	XT2S 160 MF 4 Im=56	1SDA067762R1	
			8.5	XT2S 160 MF 8,5 Im=120	1SDA067763R1	
			12.5	XT2S 160 MF 12,5 Im=175	1SDA067764R1	
XT2	160	MA	20	XT2S 160 MA 20 Im=120...280	1SDA067765R1	
			32	XT2S 160 MA 32 Im=192...448	1SDA067766R1	
			52	XT2S 160 MA 52 Im=314...728	1SDA067767R1	
			80	XT2S 160 MA 80 Im=480...1120	1SDA067768R1	
			100	XT2S 160 MA 100Im=600...1400	1SDA067769R1	
			160	XT2S 160 MA Im=960...2240	1SDA076530R1	

Generator protection circuit-breakers

SACE XT2S (50 kA) TMG - Front terminals (F)



XT2 - circuit-breaker

Size	lu	Trip units	In	Type	3 poles	4 poles
					Code	Code
XT2	160	TMG	16	XT2S 160 TMG 16-160	1SDA067738R1	1SDA067749R1
			20	XT2S 160 TMG 20-160	1SDA067739R1	1SDA067750R1
			25	XT2S 160 TMG 25-160	1SDA067740R1	1SDA067751R1
			32	XT2S 160 TMG 32-160	1SDA067741R1	1SDA067752R1
			40	XT2S 160 TMG 40-200	1SDA067742R1	1SDA067753R1
			50	XT2S 160 TMG 50-200	1SDA067743R1	1SDA067754R1
			63	XT2S 160 TMG 63-200	1SDA067744R1	1SDA067755R1
			80	XT2S 160 TMG 80-240	1SDA067745R1	1SDA067756R1
			100	XT2S 160 TMG 100-300	1SDA067746R1	1SDA067757R1
			125	XT2S 160 TMG 125-375	1SDA067747R1	1SDA067758R1
			160	XT2S 160 TMG 160-480	1SDA067748R1	1SDA067759R1

Distribution circuit-breakers

—
XT2 - circuit-breaker**SACE XT2H (70 kA) TMD/TMA - Front terminals (F)**

Size	lu	Trip units	In	Type	3 poles	4 poles
					Code	Code
XT2 160	TMD		1.6	XT2H 160 TMD 1,6-16	1SDA067584R1	1SDA067605R1
			2	XT2H 160 TMD 2-20	1SDA067585R1	1SDA067606R1
			2.5	XT2H 160 TMD 2,5-25	1SDA067586R1	1SDA067607R1
			3.2	XT2H 160 TMD 3,2-32	1SDA067587R1	1SDA067608R1
			4	XT2H 160 TMD 4-40	1SDA067588R1	1SDA067609R1
			5	XT2H 160 TMD 5-50	1SDA067589R1	1SDA067610R1
			6.3	XT2H 160 TMD 6,3-63	1SDA067590R1	1SDA067611R1
			8	XT2H 160 TMD 8-80	1SDA067591R1	1SDA067612R1
			10	XT2H 160 TMD 10-100	1SDA067592R1	1SDA067613R1
			12.5	XT2H 160 TMD 12,5-125	1SDA067593R1	1SDA067614R1
			16	XT2H 160 TMD 16-300	1SDA067594R1	1SDA067615R1
			20	XT2H 160 TMD 20-300	1SDA067595R1	1SDA067616R1
			25	XT2H 160 TMD 25-300	1SDA067596R1	1SDA067617R1
			32	XT2H 160 TMD 32-320	1SDA067597R1	1SDA067618R1
			XT2 160	TMA		40
50	XT2H 160 TMA 50-500	1SDA067599R1				1SDA067620R1
63	XT2H 160 TMA 63-630	1SDA067600R1				1SDA067621R1
80	XT2H 160 TMA 80-800	1SDA067601R1				1SDA067622R1
100	XT2H 160 TMA 100-1000	1SDA067602R1				1SDA067623R1
125	XT2H 160 TMA 125-1250	1SDA067603R1				1SDA067626R1
160	XT2H 160 TMA 160-1600	1SDA067604R1				1SDA067627R1
125	XT2H 160 TMA 125-1250 InN=50%					1SDA067624R1
160	XT2H 160 TMA 160-1600 InN=50%		1SDA067625R1			

SACE XT2H (70 kA) Ekip LS/I - Front terminals (F)

Size	lu	Trip units	In	Type	3 poles	4 poles
					Code	Code
XT2 160	Ekip LS/I		10	XT2H 160 Ekip LS/I In=10A	1SDA067857R1	1SDA067890R1
			25	XT2H 160 Ekip LS/I In=25A	1SDA067858R1	1SDA067891R1
			63	XT2H 160 Ekip LS/I In=63A	1SDA067859R1	1SDA067892R1
			100	XT2H 160 Ekip LS/I In=100A	1SDA067860R1	1SDA067893R1
			160	XT2H 160 Ekip LS/I In=160A	1SDA067861R1	1SDA067895R1

Ordering codes for XT2

Automatic circuit-breakers



—
XT2 - circuit-breaker

SACE XT2H (70 kA) Ekip I - Front terminals (F)

Size	lu	Trip units	In	Type	3 poles	4 poles
					Code	Code
XT2	160	Ekip I	10	XT2H 160 Ekip I In=10A	1SDA067862R1	1SDA067896R1
			25	XT2H 160 Ekip I In=25A	1SDA067863R1	1SDA067897R1
			63	XT2H 160 Ekip I In=63A	1SDA067864R1	1SDA067898R1
			100	XT2H 160 Ekip I In=100A	1SDA067865R1	1SDA067899R1
			160	XT2H 160 Ekip I In=160A	1SDA067866R1	1SDA067901R1

SACE XT2H (70 kA) Ekip LSI - Front terminals (F)

Size	lu	Trip units	In	Type	3 poles	4 poles
					Code	Code
XT2	160	Ekip LSI	10	XT2H 160 Ekip LSI In=10A	1SDA067867R1	1SDA067902R1
			25	XT2H 160 Ekip LSI In=25A	1SDA067868R1	1SDA067903R1
			63	XT2H 160 Ekip LSI In=63A	1SDA067869R1	1SDA067904R1
			100	XT2H 160 Ekip LSI In=100A	1SDA067870R1	1SDA067905R1
			160	XT2H 160 Ekip LSI In=160A	1SDA067871R1	1SDA067907R1

SACE XT2H (70 kA) Ekip LSIG - Front terminals (F)

Size	lu	Trip units	In	Type	3 poles	4 poles
					Code	Code
XT2	160	Ekip LSIG	10	XT2H 160 Ekip LSIG In=10A	1SDA067872R1	1SDA067908R1
			25	XT2H 160 Ekip LSIG In=25A	1SDA067873R1	1SDA067909R1
			63	XT2H 160 Ekip LSIG In=63A	1SDA067874R1	1SDA067910R1
			100	XT2H 160 Ekip LSIG In=100A	1SDA067875R1	1SDA067911R1
			160	XT2H 160 Ekip LSIG In=160A	1SDA067876R1	1SDA067913R1

SACE XT2H (70 kA) Ekip Dip LIG - Front terminals (F)

Size	lu	Trip units	In	Type	3 poles	4 poles
					Code	Code
XT2	160	Ekip Dip LIG	10	XT2H 160 Ekip Dip LIG In=10A	1SDA100070R1	1SDA100085R1
			25	XT2H 160 Ekip Dip LIG In=25A	1SDA100071R1	1SDA100086R1
			63	XT2H 160 Ekip Dip LIG In=63A	1SDA100072R1	1SDA100087R1
			100	XT2H 160 Ekip Dip LIG In=100A	1SDA100073R1	1SDA100088R1
			160	XT2H 160 Ekip Dip LIG In=160A	1SDA100074R1	1SDA100089R1

Motor protection circuit-breakers

SACE XT2H (70 kA) MF/MA - Front terminals (F)



—
XT2 - circuit-breaker

Size	lu	Trip units	In	Type	3 poles	4 poles
					Code	Code
XT2	160	MF	1	XT2H 160 MF 1 Im=14	1SDA067770R1	
			2	XT2H 160 MF 2 Im=28	1SDA067771R1	
			4	XT2H 160 MF 4 Im=56	1SDA067772R1	
			8.5	XT2H 160 MF 8,5 Im=120	1SDA067773R1	
			12.5	XT2H 160 MF 12,5 Im=175	1SDA067774R1	
XT2	160	MA	20	XT2H 160 MA 20 Im=120...280	1SDA067775R1	
			32	XT2H 160 MA 32 Im=192...448	1SDA067776R1	
			52	XT2H 160 MA 52 Im=314...728	1SDA067777R1	
			80	XT2H 160 MA 80 Im=480...1120	1SDA067778R1	
			100	XT2H 160 MA 100 Im=600...1400	1SDA067779R1	
			160	XT2H 160 MA 160 Im=960...2240	1SDA076535R1	

Ordering codes for XT2

Automatic circuit-breakers

Distribution circuit-breakers

SACE XT2L (120 kA) TMD/TMA - Front terminals (F)



—
XT2 - circuit-breaker

Size	lu	Trip units	In	Type	3 poles	4 poles
					Code	Code
XT2	160	TMD	1.6	XT2L 160 TMD 1,6-16	1SDA067628R1	1SDA067649R1
			2	XT2L 160 TMD 2-20	1SDA067629R1	1SDA067650R1
			2.5	XT2L 160 TMD 2,5-25	1SDA067630R1	1SDA067651R1
			3.2	XT2L 160 TMD 3,2-32	1SDA067631R1	1SDA067652R1
			4	XT2L 160 TMD 4-40	1SDA067632R1	1SDA067653R1
			5	XT2L 160 TMD 5-50	1SDA067633R1	1SDA067654R1
			6.3	XT2L 160 TMD 6,3-63	1SDA067634R1	1SDA067655R1
			8	XT2L 160 TMD 8-80	1SDA067635R1	1SDA067656R1
			10	XT2L 160 TMD 10-100	1SDA067636R1	1SDA067657R1
			12.5	XT2L 160 TMD 12,5-125	1SDA067637R1	1SDA067658R1
			16	XT2L 160 TMD 16-300	Only available with the Breaking Part + Trip unit solution	
			20	XT2L 160 TMD 20-300		
			25	XT2L 160 TMD 25-300		
			32	XT2L 160 TMD 32-320		
XT2	160	TMA	40	XT2L 160 TMA 40-400	Only available with the Breaking Part + Trip unit solution	
			50	XT2L 160 TMA 50-500		
			63	XT2L 160 TMA 63-630		
			80	XT2L 160 TMA 80-800		
			100	XT2L 160 TMA 100-1000		
			125	XT2L 160 TMA 125-1250		
			160	XT2L 160 TMA 160-1600		
			125	XT2L 160 TMA 125-1250 InN=50%		
			160	XT2L 160 TMA 160-1600 InN=50%		

SACE XT2L (120 kA) Ekip LS/I - Front terminals (F)

Size	lu	Trip units	In	Type	3 poles	4 poles
					Code	Code
XT2	160	Ekip LS/I	10	XT2L 160 Ekip LS/I In=10A	1SDA067914R1	1SDA067947R1
			25	XT2L 160 Ekip LS/I In=25A	Only available with the Breaking Part + Trip unit solution	
			63	XT2L 160 Ekip LS/I In=63A		
			100	XT2L 160 Ekip LS/I In=100A		
			160	XT2L 160 Ekip LS/I In=160A		



—
XT2 - circuit-breaker

SACE XT2L (120 kA) Ekip I - Front terminals (F)

Size	lu	Trip units	In	Type	3 poles	4 poles
					Code	Code
XT2	160	Ekip I	10	XT2L 160 Ekip I In=10A	1SDA067919R1	1SDA067953R1
			25	XT2L 160 Ekip I In=25A	Only available with the Breaking Part + Trip unit solution	
			63	XT2L 160 Ekip I In=63A		
			100	XT2L 160 Ekip I In=100A		
			160	XT2L 160 Ekip I In=160A		

SACE XT2L (120 kA) Ekip LSI - Front terminals (F)

Size	lu	Trip units	In	Type	3 poles	4 poles
					Code	Code
XT2	160	Ekip LSI	10	XT2L 160 Ekip LSI In=10A	1SDA067924R1	1SDA067959R1
			25	XT2L 160 Ekip LSI In=25A	Only available with the Breaking Part + Trip unit solution	
			63	XT2L 160 Ekip LSI In=63A		
			100	XT2L 160 Ekip LSI In=100A		
			160	XT2L 160 Ekip LSI In=160A		

SACE XT2L (120 kA) Ekip LSIG - Front terminals (F)

Size	lu	Trip units	In	Type	3 poles	4 poles
					Code	Code
XT2	160	Ekip LSIG	10	XT2L 160 Ekip LSIG In=10A	1SDA067929R1	1SDA067965R1
			25	XT2L 160 Ekip LSIG In=25A	Only available with the Breaking Part + Trip unit solution	
			63	XT2L 160 Ekip LSIG In=63A		
			100	XT2L 160 Ekip LSIG In=100A		
			160	XT2L 160 Ekip LSIG In=160A		

SACE XT2L (120 kA) Ekip Dip LIG - Front terminals (F)

Size	lu	Trip units	In	Type	3 poles	4 poles
					Code	Code
XT2	160	Ekip Dip LIG	10	XT2L 160 Ekip Dip LIG In=10A	1SDA101950R1	1SDA101951R1
			25	XT2L 160 Ekip Dip LIG In=25A	Only available with the Breaking Part + Trip unit solution	
			63	XT2L 160 Ekip Dip LIG In=63A		
			100	XT2L 160 Ekip Dip LIG In=100A		
			160	XT2L 160 Ekip Dip LIG In=160A		

Ordering codes for XT2

Automatic circuit-breakers

Motor protection circuit-breakers

SACE XT2L (120 kA) MF/MA - Front terminals (F)



—
XT2 - circuit-breaker

Size	lu	Trip units	In	Type	3 poles	4 poles
					Code	Code
XT2 160	MF		1	XT2L 160 MF 1 Im=14	1SDA067780R1	
			2	XT2L 160 MF 2 Im=28	1SDA067781R1	
			4	XT2L 160 MF 4 Im=56	1SDA067782R1	
			8.5	XT2L 160 MF 8,5 Im=120	1SDA067783R1	
			12.5	XT2L 160 MF 12,5 Im=175	1SDA067784R1	
XT2 160	MA		20	XT2L 160 MA 20 Im=120...280	Only available with the Breaking Part + Trip unit solution	
			32	XT2L 160 MA 32 Im=192...448		
			52	XT2L 160 MA 52 Im=314...728		
			80	XT2L 160 MA 80 Im=480...1120		
			100	XT2L 160 MA 100 Im=600...1400		
			160	XT2L 160 MA 160 Im=960....2240		

Distribution circuit-breakers



—
XT2 - circuit-breaker

SACE XT2V (150 kA) TMD/TMA - Front terminals (F)

Size	lu	Trip units	In	Type	3 poles	4 poles
					Code	Code
XT2 160	TMD		1.6	XT2V 160 TMD 1,6-16	1SDA067672R1	1SDA067693R1
			2	XT2V 160 TMD 2-20	1SDA067673R1	1SDA067694R1
			2.5	XT2V 160 TMD 2,5-25	1SDA067674R1	1SDA067695R1
			3.2	XT2V 160 TMD 3,2-32	1SDA067675R1	1SDA067696R1
			4	XT2V 160 TMD 4-40	1SDA067676R1	1SDA067697R1
			5	XT2V 160 TMD 5-50	1SDA067677R1	1SDA067698R1
			6.3	XT2V 160 TMD 6,3-63	1SDA067678R1	1SDA067699R1
			8	XT2V 160 TMD 8-80	1SDA067679R1	1SDA067700R1
			10	XT2V 160 TMD 10-100	1SDA067680R1	1SDA067701R1
			12.5	XT2V 160 TMD 12,5-125	1SDA067681R1	1SDA067702R1
			16	XT2V 160 TMD 16-300	Only available with the Breaking Part + Trip unit solution	
			20	XT2V 160 TMD 20-300		
			25	XT2V 160 TMD 25-300		
			32	XT2V 160 TMD 32-320		
XT2 160	TMA		40	XT2V 160 TMA 40-400	Only available with the Breaking Part + Trip unit solution	
			50	XT2V 160 TMA 50-500		
			63	XT2V 160 TMA 63-630		
			80	XT2V 160 TMA 80-800		
			100	XT2V 160 TMA 100-1000		
			125	XT2V 160 TMA 125-1250		
			160	XT2V 160 TMA 160-1600		
			125	XT2V 160 TMA 125-1250 InN=50%		
160	XT2V 160 TMA 160-1600 InN=50%					

SACE XT2V (150 kA) Ekip LS/I - Front terminals (F)

Size	lu	Trip units	In	Type	3 poles	4 poles
					Code	Code
XT2 160	Ekip LS/I		10	XT2V 160 Ekip LS/I In=10A	1SDA067971R1	1SDA068004R1
			25	XT2V 160 Ekip LS/I In=25A	Only available with the Breaking Part + Trip unit solution	
			63	XT2V 160 Ekip LS/I In=63A		
			100	XT2V 160 Ekip LS/I In=100A		
			160	XT2V 160 Ekip LS/I In=160A		

Ordering codes for XT2

Automatic circuit-breakers



XT2 - circuit-breaker

SACE XT2V (150 kA) Ekip I - Front terminals (F)

Size	lu	Trip units	In	Type	3 poles	4 poles
					Code	Code
XT2	160	Ekip I	10	XT2V 160 Ekip I In=10A	1SDA067976R1	1SDA068010R1
			25	XT2V 160 Ekip I In=25A	Only available with the Breaking Part + Trip unit solution	
			63	XT2V 160 Ekip I In=63A		
			100	XT2V 160 Ekip I In=100A		
			160	XT2V 160 Ekip I In=160A		

SACE XT2V (150 kA) Ekip LSI - Front terminals (F)

Size	lu	Trip units	In	Type	3 poles	4 poles
					Code	Code
XT2	160	Ekip LSI	10	XT2V 160 Ekip LSI In=10A	1SDA067981R1	1SDA068016R1
			25	XT2V 160 Ekip LSI In=25A	Only available with the Breaking Part + Trip unit solution	
			63	XT2V 160 Ekip LSI In=63A		
			100	XT2V 160 Ekip LSI In=100A		
			160	XT2V 160 Ekip LSI In=160A		

SACE XT2V (150 kA) Ekip LSIG - Front terminals (F)

Size	lu	Trip units	In	Type	3 poles	4 poles
					Code	Code
XT2	160	Ekip LSIG	10	XT2V 160 Ekip LSIG In=10A	1SDA067986R1	1SDA068022R1
			25	XT2V 160 Ekip LSIG In=25A	Only available with the Breaking Part + Trip unit solution	
			63	XT2V 160 Ekip LSIG In=63A		
			100	XT2V 160 Ekip LSIG In=100A		
			160	XT2V 160 Ekip LSIG In=160A		

SACE XT2V (150 kA) Ekip Dip LIG - Front terminals (F)

Size	lu	Trip units	In	Type	3 poles	4 poles
					Code	Code
XT2	160	Ekip Dip LIG	10	XT2V 160 Ekip Dip LIG In=10A	1SDA101952R1	1SDA101953R1
			25	XT2V 160 Ekip Dip LIG In=25A	Only available with the Breaking Part + Trip unit solution	
			63	XT2V 160 Ekip Dip LIG In=63A		
			100	XT2V 160 Ekip Dip LIG In=100A		
			160	XT2V 160 Ekip Dip LIG In=160A		

Motor protection circuit-breakers

SACE XT2V (150 kA) MF/MA - Front terminals (F)—
XT2 - circuit-breaker

Size	lu	Trip units	In	Type	3 poles	4 poles
					Code	Code
XT2	160	MF	1	XT2V 160 MF 1 Im=14	1SDA067790R1	
			2	XT2V 160 MF 2 Im=28	1SDA067791R1	
			4	XT2V 160 MF 4 Im=56	1SDA067792R1	
			8.5	XT2V 160 MF 8,5 Im=120	1SDA067793R1	
			12.5	XT2V 160 MF 12,5 Im=175	1SDA067794R1	
XT2	160	MA	20	XT2V 160 MA 20 Im=120...280	Only available with the Breaking Part + Trip unit solution	
			32	XT2V 160 MA 32 Im=192...448		
			52	XT2V 160 MA 52 Im=314...728		
			80	XT2V 160 MA 80 Im=480...1120		
			100	XT2V 160 MA 100 Im=600...1400		
			160	XT2V 160 MA 160 Im=960...2240		

Ordering codes for XT2

Breaking part



—
XT2 - breaking part

SACE XT2 - Breaking part

Size	Iu	Icu (415 V)	Type	3 poles	4 poles
				Code	Code
XT2	160	36	XT2N 160 Breaking part	1SDA068163R1	1SDA068168R1
	160	50	XT2S 160 Breaking part	1SDA068164R1	1SDA068169R1
	160	70	XT2H 160 Breaking part	1SDA068165R1	1SDA068170R1
	160	120	XT2L 160 Breaking part	1SDA068166R1	1SDA068171R1
	160	150	XT2V 160 Breaking part	1SDA068167R1	1SDA068172R1

Ordering codes for XT2

Trip units

Trip units - Distribution protection

Size	Type	3 poles	4 poles
		Code	Code
XT2	TMD 16-300	1SDA067226R1	1SDA067247R1
	TMD 20-300	1SDA067227R1	1SDA067248R1
	TMD 25-300	1SDA067228R1	1SDA067249R1
	TMD 32-320	1SDA067229R1	1SDA067250R1
	TMA 40-400	1SDA067230R1	1SDA067251R1
	TMA 50-500	1SDA067231R1	1SDA067252R1
	TMA 63-630	1SDA067232R1	1SDA067253R1
	TMA 80-800	1SDA067233R1	1SDA067254R1
	TMA 100-1000	1SDA067234R1	1SDA067255R1
	TMA 125-1250	1SDA067235R1	1SDA067258R1
	TMA 160-1600	1SDA067236R1	1SDA067259R1
	TMA 125-1250 InN=50%		1SDA067256R1
	TMA 160-1600 InN=50%		1SDA067257R1
	Ekip LS/I In=25A	1SDA067296R1	1SDA067329R1
	Ekip LS/I In=63A	1SDA067297R1	1SDA067330R1
	Ekip LS/I In=100A	1SDA067298R1	1SDA067331R1
	Ekip LS/I In=160A	1SDA067299R1	1SDA067333R1
	Ekip I In=25A	1SDA067301R1	1SDA067335R1
	Ekip I In=63A	1SDA067302R1	1SDA067336R1
	Ekip I In=100A	1SDA067303R1	1SDA067337R1
	Ekip I In=160A	1SDA067304R1	1SDA067339R1
	Ekip LSI In=25A	1SDA067306R1	1SDA067341R1
	Ekip LSI In=63A	1SDA067307R1	1SDA067342R1
	Ekip LSI In=100A	1SDA067308R1	1SDA067343R1
	Ekip LSI In=160A	1SDA067309R1	1SDA067345R1
	Ekip LSIG In=25A	1SDA067311R1	1SDA067347R1
	Ekip LSIG In=63A	1SDA067312R1	1SDA067348R1
	Ekip LSIG In=100A	1SDA067313R1	1SDA068052R1
	Ekip LSIG In=160A	1SDA067314R1	1SDA067350R1
	Ekip Dip LIG In=25A	1SDA100128R1	1SDA100167R1
	Ekip Dip LIG In=63A	1SDA100129R1	1SDA100168R1
	Ekip Dip LIG In=100A	1SDA100130R1	1SDA100169R1
	Ekip Dip LIG In=160A	1SDA100131R1	1SDA100170R1
Ekip Touch LSI In=40A	1SDA100100R1	1SDA100142R1	
Ekip Touch LSI In=63A	1SDA100101R1	1SDA100143R1	
Ekip Touch LSI In=100A	1SDA100102R1	1SDA100144R1	
Ekip Touch LSI In=160A	1SDA100103R1	1SDA100145R1	
Ekip Touch LSIG In=40A	1SDA100104R1	1SDA100146R1	
Ekip Touch LSIG In=63A	1SDA100105R1	1SDA100147R1	
Ekip Touch LSIG In=100A	1SDA100106R1	1SDA100148R1	
Ekip Touch LSIG In=160A	1SDA100107R1	1SDA100149R1	
Ekip Touch Measuring LSI In=40A	1SDA100108R1	1SDA100150R1	
Ekip Touch Measuring LSI In=63A	1SDA100109R1	1SDA100151R1	
Ekip Touch Measuring LSI In=100A	1SDA100110R1	1SDA100153R1	
Ekip Touch Measuring LSI In=160A	1SDA100111R1	1SDA100152R1	



Thermal magnetic trip unit



Dip trip unit



Touch trip unit

Ordering codes for XT2

Trip units



Touch trip unit

Trip units - Distribution protection

Size	Type	3 poles	4 poles
		Code	Code
XT2	Ekip Touch Measuring LSIG In=40A	1SDA100112R1	1SDA100154R1
	Ekip Touch Measuring LSIG In=63A	1SDA100113R1	1SDA100155R1
	Ekip Touch Measuring LSIG In=100A	1SDA100114R1	1SDA100156R1
	Ekip Touch Measuring LSIG In=160A	1SDA100115R1	1SDA100157R1
	Ekip Hi-Touch LSI In=40A	1SDA100116R1	1SDA100158R1
	Ekip Hi-Touch LSI In=63A	1SDA100117R1	1SDA100159R1
	Ekip Hi-Touch LSI In=100A	1SDA100118R1	1SDA100160R1
	Ekip Hi-Touch LSI In=160A	1SDA100119R1	1SDA100161R1
	Ekip Hi-Touch LSIG In=40A	1SDA100120R1	1SDA100162R1
	Ekip Hi-Touch LSIG In=63A	1SDA100121R1	1SDA100163R1
	Ekip Hi-Touch LSIG In=100A	1SDA100122R1	1SDA100164R1
	Ekip Hi-Touch LSIG In=160A	1SDA100123R1	1SDA100165R1

Trip units - Motor protection

Size	Type	3 poles	4 poles
		Code	Code
XT2	MA 20 Im=120...280	1SDA067290R1	
	MA 32 Im=192...448	1SDA067291R1	
	MA 52 Im=314...728	1SDA067292R1	
	MA 80 Im=480...1120	1SDA067293R1	
	MA 100 Im=600...1400	1SDA067294R1	
	MA 160 Im=960...2240	1SDA076538R1	
	Ekip M-LIU In=25A	1SDA067352R1	
	Ekip M-LIU In=63A	1SDA067353R1	
	Ekip M-LIU In=100A	1SDA067354R1	
	Ekip M-LIU In=160A	1SDA067355R1	
	Ekip M-LRIU In=25A	1SDA067357R1	
	Ekip M-LRIU In=63A	1SDA067358R1	
	Ekip M-LRIU In=100A	1SDA067359R1	
	Ekip M Touch LRIU In=40A	1SDA100124R1	
	Ekip M Touch LRIU In=63A	1SDA100125R1	
	Ekip M Touch LRIU In=100A	1SDA100126R1	

Trip units - Generator protection

Size	Type	3 poles	4 poles
		Code	Code
XT2	Ekip G-LS/I In=25A	1SDA067362R1	1SDA067368R1
	Ekip G-LS/I In=63A	1SDA067363R1	1SDA067369R1
	Ekip G-LS/I In=100A	1SDA067364R1	1SDA067370R1
	Ekip G-LS/I In=160A	1SDA067365R1	1SDA067372R1

Ordering codes for XT2

Breaking part + trip unit solution



XT2 - breaking part



TMA trip unit



Ekip Dip trip unit



Ekip Touch trip unit

Breaking Part	Icu Poles	N (36 kA)		S (50 kA)		H (70 kA)		L (120 kA)		V (150 kA)																
		3	4	3	4	3	4	3	4	3	4															
	3	068163		068164		068165		068166		068167																
	4	068168		068169		068170		068171		068172																
Trip units																										
	In Poles	16		20		25		32		40		50		52		63		80		100		125		160		
		3	4	3	4	3	4	3	4	3	4	3	4	3	4	3	4	3	4	3	4	3	4	3	4	
TMD	3	067226	067227	067228	067229																					
	4	067247	067248	067249	067250																					
TMA	3							067230	067231		067232	067233	067234	067235	067236											
	4							067251	067252		067253	067254	067255	067258*	067259*											
Ekip LS/I	3			067296						067297		067298		067299												
	4			067329						067330		067331		067333												
Ekip I	3			067301						067302		067303		067304												
	4			067335						067336		067337		067339												
Ekip LSI	3			067306						067307		067308		067309												
	4			067341						067342		067343		067345												
Ekip LSIG	3			067311						067312		067313		067314												
	4			067347						067348		068052		067350												
Ekip Dip LIG	3			100128						100129		100130		100131												
	4			100167						100168		100169		100170												
Ekip Touch LSI	3							100100		100101		100102		100103												
	4							100142		100143		100144		100145												
Ekip Touch LSIG	3							100104		100105		100106		100107												
	4							100146		100147		100148		100149												
Ekip Touch Measuring LSI	3							100108		100109		100110		100111												
	4							100150		100151		100152		100153												
Ekip Touch Measuring LSIG	3							100112		100113		100114		100115												
	4							100154		100155		100156		100157												
Ekip Hi-Touch LSI	3							100116		100117		100118		100119												
	4							100158		100159		100160		100161												
Ekip Hi-Touch LSIG	3							100120		100121		100122		100123												
	4							100162		100163		100164		100165												
MA	3		067290		067291					067292		067293	067294	076538												
Ekip M LIU	3			067352						067353		067354		067355												
Ekip M-LRIU				067357						067358		067359														
Ekip M Touch LRIU	3							100124		100125		100126														
Ekip G LS/I	3			067362						067363		067364		067365												
	4			067368						067369		067370		067372												

*InN=100%. Combinations available for InN=50% too. For ordering codes, please see in reference pages 'trip Units'

Note: when a single code for the complete circuit-breaker is not available, please configure the breaking part code with the trip unit code to order a factory-assembled circuit-breaker.

Ordering codes for XT3

Automatic circuit-breakers

Distribution circuit-breakers

SACE XT3N (36kA) TMD - Front terminals (F)

Size	lu	Trip units	In	Type	3 poles	4 poles
					Code	Code
XT3	250	TMD	63	XT3N 250 TMD 63-630	1SDA068053R1	1SDA068060R1
			80	XT3N 250 TMD 80-800	1SDA068054R1	1SDA068061R1
			100	XT3N 250 TMD 100-1000	1SDA068055R1	1SDA068062R1
			125	XT3N 250 TMD 125-1250	1SDA068056R1	1SDA068067R1
			160	XT3N 250 TMD 160-1600	1SDA068057R1	1SDA068068R1
			125	XT3N 250 TMD 125-1250 InN=50%		1SDA068063R1
			160	XT3N 250 TMD 160-1600 InN=50%		1SDA068064R1
			200	XT3N 250 TMD 200-2000	1SDA068058R1	1SDA068069R1
			250	XT3N 250 TMD 250-2500	1SDA068059R1	1SDA068070R1
			200	XT3N 250 TMD 200-2000 InN=50%		1SDA068065R1
			250	XT3N 250 TMD 250-2500 InN=50%		1SDA068066R1



XT3 - circuit-breaker

Motor protection circuit-breakers

SACE XT3N (36kA) MA - Front terminals (F)

Size	lu	Trip units	In	Type	3 poles	4 poles
					Code	Code
XT3	250	MA	100	XT3N 250 MA 100 Im=600...1200	1SDA068071R1	
			125	XT3N 250 MA 125 Im=750...1500	1SDA068072R1	
			160	XT3N 250 MA 160 Im=960...1920	1SDA068073R1	
			200	XT3N 250 MA 200 Im=1200...2400	1SDA068074R1	



XT3 - circuit-breaker

Generator protection circuit-breakers

SACE XT3N (36kA) TMG - Front terminals (F)

Size	lu	Trip units	In	Type	3 poles	4 poles
					Code	Code
XT3	250	TMG	63	XT3N 250 TMG 63-400	1SDA068251R1	1SDA068258R1
			80	XT3N 250 TMG 80-400	1SDA068252R1	1SDA068259R1
			100	XT3N 250 TMG 100-400	1SDA068253R1	1SDA068260R1
			125	XT3N 250 TMG 125-400	1SDA068254R1	1SDA068261R1
			160	XT3N 250 TMG 160-480	1SDA068255R1	1SDA068262R1
			200	XT3N 250 TMG 200-600	1SDA068256R1	1SDA068263R1
			250	XT3N 250 TMG 250-750	1SDA068257R1	1SDA068264R1



XT3 - circuit-breaker

Distribution circuit-breakers

SACE XT3S (50kA) TMD - Front terminals (F)

Size	lu	Trip units	In	Type	3 poles	4 poles
					Code	Code
XT3	250	TMD	63	XT3S 250 TMD 63-630	1SDA068215R1	1SDA068222R1
			80	XT3S 250 TMD 80-800	1SDA068216R1	1SDA068223R1
			100	XT3S 250 TMD 100-1000	1SDA068217R1	1SDA068224R1
			125	XT3S 250 TMD 125-1250	1SDA068218R1	1SDA068229R1
			160	XT3S 250 TMD 160-1600	1SDA068219R1	1SDA068230R1
			125	XT3S 250 TMD 125-1250 InN=50%		1SDA068225R1
			160	XT3S 250 TMD 160-1600 InN=50%		1SDA068226R1
			200	XT3S 250 TMD 200-2000	1SDA068220R1	1SDA068231R1
			250	XT3S 250 TMD 250-2500	1SDA068221R1	1SDA068232R1
			200	XT3S 250 TMD 200-2000 InN=50%		1SDA068227R1
			250	XT3S 250 TMD 250-2500 InN=50%		1SDA068228R1



XT3 - circuit-breaker

Motor protection circuit-breakers

SACE XT3S (50kA) MA - Front terminals (F)

Size	lu	Trip units	In	Type	3 poles	4 poles
					Code	Code
XT3	250	MA	100	XT3S 250 MA 100 Im=600...1200	1SDA068279R1	
			125	XT3S 250 MA 125 Im=750...1500	1SDA068280R1	
			160	XT3S 250 MA 160 Im=960...1920	1SDA068281R1	
			200	XT3S 250 MA 200 Im=1200...2400	1SDA068282R1	



XT3 - circuit-breaker

Generator protection circuit-breakers

SACE XT3S (50kA) TMG - Front terminals (F)

Size	lu	Trip units	In	Type	3 poles	4 poles
					Code	Code
XT3	250	TMG	63	XT3S 250 TMG 63-400	1SDA068265R1	1SDA068272R1
			80	XT3S 250 TMG 80-400	1SDA068266R1	1SDA068273R1
			100	XT3S 250 TMG 100-400	1SDA068267R1	1SDA068274R1
			125	XT3S 250 TMG 125-400	1SDA068268R1	1SDA068275R1
			160	XT3S 250 TMG 160-480	1SDA068269R1	1SDA068276R1
			200	XT3S 250 TMG 200-600	1SDA068270R1	1SDA068277R1
			250	XT3S 250 TMG 250-750	1SDA068271R1	1SDA068278R1



XT3 - circuit-breaker

Ordering codes for XT3

Switch-disconnectors



XT3D -
switch-disconnector

SACE XT3D - Switch-disconnectors

Size	Iu	Type	3 poles	4 poles
			Code	Code
XT3	250	XT3D 250	1SDA068210R1	1SDA068211R1

Ordering codes for XT4

Automatic circuit-breakers

Distribution circuit-breakers



XT4 - circuit-breaker

SACE XT4N (36 kA) TMD/TMA - Front terminals (F)

Size	lu	Trip units	In	Type	3 poles	4 poles
					Code	Code
XT4	160	TMD	16	XT4N 160 TMD 16-300	1SDA068076R1	1SDA068093R1
			20	XT4N 160 TMD 20-300	1SDA068080R1	1SDA068094R1
			25	XT4N 160 TMD 25-300	1SDA068081R1	1SDA068095R1
			32	XT4N 160 TMD 32-320	1SDA068082R1	1SDA068096R1
XT4	160	TMA	40	XT4N 160 TMA 40-400	1SDA068083R1	1SDA068097R1
			50	XT4N 160 TMA 50-500	1SDA068084R1	1SDA068098R1
			63	XT4N 160 TMA 63-630	1SDA068085R1	1SDA068099R1
			80	XT4N 160 TMA 80-800	1SDA068086R1	1SDA068100R1
			100	XT4N 160 TMA 100-1000	1SDA068087R1	1SDA068101R1
			125	XT4N 160 TMA 125-1250	1SDA068088R1	1SDA068107R1
			160	XT4N 160 TMA 160-1600	1SDA068089R1	1SDA068108R1
			125	XT4N 160 TMA 125-1250 InN=50%		1SDA068102R1
			160	XT4N 160 TMA 160-1600 InN=50%		1SDA068103R1
			XT4	250	TMA	200
225	XT4N 250 TMA 225-2250	1SDA068091R1				1SDA068110R1
250	XT4N 250 TMA 250-2500	1SDA068092R1				1SDA068111R1
200	XT4N 250 TMA 200-2000 InN=50%					1SDA068104R1
225	XT4N 250 TMA 225-2250 InN=50%					1SDA068105R1
250	XT4N 250 TMA 250-2500 InN=50%					1SDA068106R1

SACE XT4N (36 kA) Ekip LS/I - Front terminals (F)

Size	lu	Trip units	In	Type	3 poles	4 poles
					Code	Code
XT4	160	Ekip LS/I	40	XT4N 160 Ekip LS/I In=40A	1SDA068122R1	1SDA068142R1
			63	XT4N 160 Ekip LS/I In=63A	1SDA068123R1	1SDA068144R1
			100	XT4N 160 Ekip LS/I In=100A	1SDA068124R1	1SDA068145R1
			160	XT4N 160 Ekip LS/I In=160A	1SDA068125R1	1SDA068146R1
XT4	250	Ekip LS/I	250	XT4N 250 Ekip LS/I In=250A	1SDA068126R1	1SDA068147R1

SACE XT4N (36 kA) Ekip I - Front terminals (F)

Size	lu	Trip units	In	Type	3 poles	4 poles
					Code	Code
XT4	160	Ekip I	40	XT4N 160 Ekip I In=40A	1SDA068127R1	1SDA068148R1
			63	XT4N 160 Ekip I In=63A	1SDA068128R1	1SDA068149R1
			100	XT4N 160 Ekip I In=100A	1SDA068129R1	1SDA068150R1
			160	XT4N 160 Ekip I In=160A	1SDA068130R1	1SDA068151R1
XT4	250	Ekip I	250	XT4N 250 Ekip I In=250A	1SDA068131R1	1SDA068152R1

Ordering codes for XT4

Automatic circuit-breakers



XT4 - circuit-breaker

SACE XT4N (36 kA) Ekip LSI - Front terminals (F)

Size	lu	Trip units	In	Type	3 poles	4 poles
					Code	Code
XT4	160	Ekip LSI	40	XT4N 160 Ekip LSI In=40A	1SDA068132R1	1SDA068153R1
			63	XT4N 160 Ekip LSI In=63A	1SDA068133R1	1SDA068154R1
			100	XT4N 160 Ekip LSI In=100A	1SDA068134R1	1SDA068155R1
			160	XT4N 160 Ekip LSI In=160A	1SDA068135R1	1SDA068156R1
XT4	250	Ekip LSI	250	XT4N 250 Ekip LSI In=250A	1SDA068136R1	1SDA068157R1

SACE XT4N (36 kA) Ekip LSIG - Front terminals (F)

Size	lu	Trip units	In	Type	3 poles	4 poles
					Code	Code
XT4	160	Ekip LSIG	40	XT4N 160 Ekip LSIG In=40A	1SDA068137R1	1SDA068158R1
			63	XT4N 160 Ekip LSIG In=63A	1SDA068138R1	1SDA068159R1
			100	XT4N 160 Ekip LSIG In=100A	1SDA068139R1	1SDA068160R1
			160	XT4N 160 Ekip LSIG In=160A	1SDA068140R1	1SDA068161R1
XT4	250	Ekip LSIG	250	XT4N 250 Ekip LSIG In=250A	1SDA068141R1	1SDA068162R1

SACE XT4N (36 kA) Ekip Dip LIG - Front terminals (F)

Size	lu	Trip units	In	Type	3 poles	4 poles
					Code	Code
XT4	160	Ekip Dip LIG	40	XT4N 160 Ekip Dip LIG In=40A	1SDA100181R1	1SDA100196R1
			63	XT4N 160 Ekip Dip LIG In=63A	1SDA100182R1	1SDA100197R1
			100	XT4N 160 Ekip Dip LIG In=100A	1SDA100183R1	1SDA100198R1
			160	XT4N 160 Ekip Dip LIG In=160A	1SDA100184R1	1SDA100199R1
XT4	250	Ekip Dip LIG	250	XT4N 250 Ekip Dip LIG In=250A	1SDA100185R1	1SDA100200R1

Motor protection circuit-breakers

SACE XT4N (36 kA) MA - Front terminals (F)



XT4 - circuit-breaker

Size	lu	Trip units	In	Type	3 poles	4 poles
					Code	Code
XT4 160	MA		10	XT4N 160 MA 10 Im=50...100	1SDA068112R1	
			12,5	XT4N 160 MA 12,5 Im=62,5...125	1SDA068113R1	
			20	XT4N 160 MA 20 Im=100...200	1SDA068114R1	
			32	XT4N 160 MA 32 Im=160...320	1SDA068115R1	
			52	XT4N 160 MA 52 Im=260...520	1SDA068116R1	
			80	XT4N 160 MA 80 Im=400...800	1SDA068117R1	
			100	XT4N 160 MA 100 Im=500...1000	1SDA068118R1	
			125	XT4N 160 MA 125 Im=625...1160	1SDA068119R1	
			160	XT4N 160 MA 160 Im=800...1600	1SDA068120R1	
XT4 250	MA		200	XT4N 250 MA 200 Im=1000...2000	1SDA068121R1	

Distribution circuit-breakers

SACE XT4S (50 kA) TMD/TMA - Front terminals (F)



XT4 - circuit-breaker

Size	lu	Trip units	In	Type	3 poles	4 poles
					Code	Code
XT4 160	TMD		16	XT4S 160 TMD 16-300	1SDA068299R1	1SDA068313R1
			20	XT4S 160 TMD 20-300	1SDA068300R1	1SDA068314R1
			25	XT4S 160 TMD 25-300	1SDA068301R1	1SDA068315R1
			32	XT4S 160 TMD 32-320	1SDA068302R1	1SDA068316R1
XT4 160	TMA		40	XT4S 160 TMA 40-400	1SDA068303R1	1SDA068317R1
			50	XT4S 160 TMA 50-500	1SDA068304R1	1SDA068318R1
			63	XT4S 160 TMA 63-630	1SDA068305R1	1SDA068319R1
			80	XT4S 160 TMA 80-800	1SDA068306R1	1SDA068320R1
			100	XT4S 160 TMA 100-1000	1SDA068307R1	1SDA068321R1
			125	XT4S 160 TMA 125-1250	1SDA068308R1	1SDA068327R1
			160	XT4S 160 TMA 160-1600	1SDA068309R1	1SDA068328R1
			125	XT4S 160 TMA 125-1250 InN=50%		1SDA068322R1
			160	XT4S 160 TMA 160-1600 InN=50%		1SDA068323R1
			XT4 250	TMA		200
225	XT4S 250 TMA 225-2250	1SDA068311R1				1SDA068330R1
250	XT4S 250 TMA 250-2500	1SDA068312R1				1SDA068331R1
200	XT4S 250 TMA 200-2000 InN=50%					1SDA068324R1
225	XT4S 250 TMA 225-2250 InN=50%					1SDA068325R1
250	XT4S 250 TMA 250-2500 InN=50%					1SDA068326R1

Ordering codes for XT4

Automatic circuit-breakers



XT4 - circuit-breaker

SACE XT4S (50 kA) Ekip LS/I - Front terminals (F)

Size	Iu	Trip units	In	Type	3 poles	4 poles
					Code	Code
XT4	160	Ekip LS/I	40	XT4S 160 Ekip LS/I In=40A	1SDA068471R1	1SDA068491R1
			63	XT4S 160 Ekip LS/I In=63A	1SDA068472R1	1SDA068492R1
			100	XT4S 160 Ekip LS/I In=100A	1SDA068473R1	1SDA068493R1
			160	XT4S 160 Ekip LS/I In=160A	1SDA068474R1	1SDA068494R1
XT4	250	Ekip LS/I	250	XT4S 250 Ekip LS/I In=250A	1SDA068475R1	1SDA068495R1

SACE XT4S (50 kA) Ekip I - Front terminals (F)

Size	Iu	Trip units	In	Type	3 poles	4 poles
					Code	Code
XT4	160	Ekip I	40	XT4S 160 Ekip I In=40A	1SDA068476R1	1SDA068496R1
			63	XT4S 160 Ekip I In=63A	1SDA068477R1	1SDA068497R1
			100	XT4S 160 Ekip I In=100A	1SDA068478R1	1SDA068498R1
			160	XT4S 160 Ekip I In=160A	1SDA068479R1	1SDA068499R1
XT4	250	Ekip I	250	XT4S 250 Ekip I In=250A	1SDA068480R1	1SDA068500R1

SACE XT4S (50 kA) Ekip LSI - Front terminals (F)

Size	Iu	Trip units	In	Type	3 poles	4 poles
					Code	Code
XT4	160	Ekip LSI	40	XT4S 160 Ekip LSI In=40A	1SDA068481R1	1SDA068501R1
			63	XT4S 160 Ekip LSI In=63A	1SDA068482R1	1SDA068502R1
			100	XT4S 160 Ekip LSI In=100A	1SDA068483R1	1SDA068503R1
			160	XT4S 160 Ekip LSI In=160A	1SDA068484R1	1SDA068504R1
XT4	250	Ekip LSI	250	XT4S 250 Ekip LSI In=250A	1SDA068485R1	1SDA068505R1

SACE XT4S (50 kA) Ekip LSIG - Front terminals (F)

Size	Iu	Trip units	In	Type	3 poles	4 poles
					Code	Code
XT4	160	Ekip LSIG	40	XT4S 160 Ekip LSIG In=40A	1SDA068486R1	1SDA068506R1
			63	XT4S 160 Ekip LSIG In=63A	1SDA068487R1	1SDA068507R1
			100	XT4S 160 Ekip LSIG In=100A	1SDA068488R1	1SDA068508R1
			160	XT4S 160 Ekip LSIG In=160A	1SDA068489R1	1SDA068509R1
XT4	250	Ekip LSIG	250	XT4S 250 Ekip LSIG In=250A	1SDA068490R1	1SDA068510R1

SACE XT4S (50 kA) Ekip Dip LIG - Front terminals (F)

Size	Iu	Trip units	In	Type	3 poles	4 poles
					Code	Code
XT4	160	Ekip Dip LIG	40	XT4S 160 Ekip Dip LIG In=40A	1SDA100211R1	1SDA100226R1
			63	XT4S 160 Ekip Dip LIG In=63A	1SDA100212R1	1SDA100227R1
			100	XT4S 160 Ekip Dip LIG In=100A	1SDA100213R1	1SDA100228R1
			160	XT4S 160 Ekip Dip LIG In=160A	1SDA100214R1	1SDA100229R1
XT4	250	Ekip Dip LIG	250	XT4S 250 Ekip Dip LIG In=250A	1SDA100215R1	1SDA100230R1

Motor protection circuit-breakers

SACE XT4S (50 kA) MA - Front terminals (F)



XT4 - circuit-breaker

Size	lu	Trip units	In	Type	3 poles	4 poles
					Code	Code
XT4	160	MA	10	XT4S 160 MA 10 Im=50...100	1SDA068431R1	
			12,5	XT4S 160 MA 12,5 Im=62,5...125	1SDA068432R1	
			20	XT4S 160 MA 20 Im=100...200	1SDA068433R1	
			32	XT4S 160 MA 32 Im=160...320	1SDA068434R1	
			52	XT4S 160 MA 52 Im=260...520	1SDA068435R1	
			80	XT4S 160 MA 80 Im=400...800	1SDA068436R1	
			100	XT4S 160 MA 100 Im=500...1000	1SDA068437R1	
			125	XT4S 160 MA 125 Im=625...1160	1SDA068438R1	
			160	XT4S 160 MA 160 Im=800...1600	1SDA068439R1	
XT4	250	MA	200	XT4S 250 MA 200 Im=1000...2000	1SDA068440R1	

Ordering codes for XT4

Automatic circuit-breakers

Distribution circuit-breakers

SACE XT4H (70 kA) TMD/TMA - Front terminals (F)



XT4 - circuit-breaker

Size	lu	Trip units	In	Type	3 poles	4 poles
					Code	Code
XT4	160	TMD	16	XT4H 160 TMD 16-300	1SDA068332R1	1SDA068346R1
			20	XT4H 160 TMD 20-300	1SDA068333R1	1SDA068347R1
			25	XT4H 160 TMD 25-300	1SDA068334R1	1SDA068348R1
			32	XT4H 160 TMD 32-320	1SDA068335R1	1SDA068349R1
XT4	160	TMA	40	XT4H 160 TMA 40-400	1SDA068336R1	1SDA068350R1
			50	XT4H 160 TMA 50-500	1SDA068337R1	1SDA068351R1
			63	XT4H 160 TMA 63-630	1SDA068338R1	1SDA068352R1
			80	XT4H 160 TMA 80-800	1SDA068339R1	1SDA068353R1
			100	XT4H 160 TMA 100-1000	1SDA068340R1	1SDA068354R1
			125	XT4H 160 TMA 125-1250	1SDA068341R1	1SDA068360R1
			160	XT4H 160 TMA 160-1600	1SDA068342R1	1SDA068361R1
			125	XT4H 160 TMA 125-1250 InN=50%		1SDA068355R1
			160	XT4H 160 TMA 160-1600 InN=50%		1SDA068356R1
			XT4	250	TMA	200
225	XT4H 250 TMA 225-2250	1SDA068344R1				1SDA068363R1
250	XT4H 250 TMA 250-2500	1SDA068345R1				1SDA068364R1
200	XT4H 250 TMA 200-2000 InN=50%					1SDA068357R1
225	XT4H 250 TMA 225-2250 InN=50%					1SDA068358R1
250	XT4H 250 TMA 250-2500 InN=50%					1SDA068359R1

SACE XT4H (70 kA) Ekip LS/I - Front terminals (F)

Size	lu	Trip units	In	Type	3 poles	4 poles
					Code	Code
XT4	160	Ekip LS/I	40	XT4H 160 Ekip LS/I In=40A	1SDA068511R1	1SDA068531R1
			63	XT4H 160 Ekip LS/I In=63A	1SDA068512R1	1SDA068532R1
			100	XT4H 160 Ekip LS/I In=100A	1SDA068513R1	1SDA068533R1
			160	XT4H 160 Ekip LS/I In=160A	1SDA068514R1	1SDA068534R1
XT4	250	Ekip LS/I	250	XT4H 250 Ekip LS/I In=250A	1SDA068515R1	1SDA068535R1

SACE XT4H (70 kA) Ekip I - Front terminals (F)

Size	lu	Trip units	In	Type	3 poles	4 poles
					Code	Code
XT4	160	Ekip I	40	XT4H 160 Ekip I In=40A	1SDA068516R1	1SDA068536R1
			63	XT4H 160 Ekip I In=63A	1SDA068517R1	1SDA068537R1
			100	XT4H 160 Ekip I In=100A	1SDA068518R1	1SDA068538R1
			160	XT4H 160 Ekip I In=160A	1SDA068519R1	1SDA068539R1
XT4	250	Ekip I	250	XT4H 250 Ekip I In=250A	1SDA068520R1	1SDA068540R1



XT4 - circuit-breaker

SACE XT4H (70 kA) Ekip LSI - Front terminals (F)

Size	lu	Trip units	In	Type	3 poles	4 poles
					Code	Code
XT4	160	Ekip LSI	40	XT4H 160 Ekip LSI In=40A	1SDA068521R1	1SDA068541R1
			63	XT4H 160 Ekip LSI In=63A	1SDA068522R1	1SDA068542R1
			100	XT4H 160 Ekip LSI In=100A	1SDA068523R1	1SDA068543R1
			160	XT4H 160 Ekip LSI In=160A	1SDA068524R1	1SDA068544R1
XT4	250	Ekip LSI	250	XT4H 250 Ekip LSI In=250A	1SDA068525R1	1SDA068545R1

SACE XT4H (70 kA) Ekip LSI G - Front terminals (F)

Size	lu	Trip units	In	Type	3 poles	4 poles
					Code	Code
XT4	160	Ekip LSI G	40	XT4H 160 Ekip LSI G In=40A	1SDA068526R1	1SDA068546R1
			63	XT4H 160 Ekip LSI G In=63A	1SDA068527R1	1SDA068547R1
			100	XT4H 160 Ekip LSI G In=100A	1SDA068528R1	1SDA068548R1
			160	XT4H 160 Ekip LSI G In=160A	1SDA068529R1	1SDA068549R1
XT4	250	Ekip LSI G	250	XT4H 250 Ekip LSI G In=250A	1SDA068530R1	1SDA068550R1

SACE XT4H (70 kA) Ekip Dip LIG - Front terminals (F)

Size	lu	Trip units	In	Type	3 poles	4 poles
					Code	Code
XT4	160	Ekip Dip LIG	40	XT4H 160 Ekip Dip LIG In=40A	1SDA100241R1	1SDA100256R1
			63	XT4H 160 Ekip Dip LIG In=63A	1SDA100242R1	1SDA100257R1
			100	XT4H 160 Ekip Dip LIG In=100A	1SDA100243R1	1SDA100258R1
			160	XT4H 160 Ekip Dip LIG In=160A	1SDA100244R1	1SDA100259R1
XT4	250	Ekip Dip LIG	250	XT4H 250 Ekip Dip LIG In=250A	1SDA100245R1	1SDA100260R1

Ordering codes for XT4

Automatic circuit-breakers

Motor protection circuit-breakers



XT4 - circuit-breaker

SACE XT4H (70 kA) MA - Front terminals (F)

Size	Iu	Trip units	In	Type	3 poles	4 poles
					Code	Code
XT4	160	MA	10	XT4H 160 MA 10 Im=50...100	1SDA068441R1	
			12,5	XT4H 160 MA 12,5 Im=62,5...125	1SDA068442R1	
			20	XT4H 160 MA 20 Im=100...200	1SDA068443R1	
			32	XT4H 160 MA 32 Im=160...320	1SDA068444R1	
			52	XT4H 160 MA 52 Im=260...520	1SDA068445R1	
			80	XT4H 160 MA 80 Im=400...800	1SDA068446R1	
			100	XT4H 160 MA 100 Im=500...1000	1SDA068447R1	
			125	XT4H 160 MA 125 Im=625...1160	1SDA068448R1	
		160	XT4H 160 MA 160 Im=800...1600	1SDA068449R1		
XT4	250	MA	200	XT4H 250 MA 200 Im=1000...2000	1SDA068450R1	

Distribution circuit-breakers



XT4 - circuit-breaker

SACE XT4L (120 kA) TMD - Front terminals (F)

Size	Iu	Trip units	In	Type	3 poles	4 poles
					Code	Code
XT4	160	TMD	16	XT4L 160 TMD 16-300		Only available with the Breaking Part + Trip unit solution
			20	XT4L 160 TMD 20-300		
			25	XT4L 160 TMD 25-300		
			32	XT4L 160 TMD 32-320		

SACE XT4L (120 kA) TMA - Front terminals (F)

Size	Iu	Trip units	In	Type	3 poles	4 poles
					Code	Code
XT4	160	TMA	40	XT4L 160 TMA 40-400		Only available with the Breaking Part + Trip unit solution
			50	XT4L 160 TMA 50-500		
			63	XT4L 160 TMA 63-630		
			80	XT4L 160 TMA 80-800		
			100	XT4L 160 TMA 100-1000		
			125	XT4L 160 TMA 125-1250		
			160	XT4L 160 TMA 160-1600		
			125	XT4L 160 TMA 125-1250 InN=50%		
			160	XT4L 160 TMA 160-1600 InN=50%		
			XT4	250		
225	XT4L 250 TMA 225-2250					
250	XT4L 250 TMA 250-2500					
200	XT4L 250 TMA 200-2000 InN=50%					
225	XT4L 250 TMA 225-2250 InN=50%					
250	XT4L 250 TMA 250-2500 InN=50%					



—
XT4 - circuit-breaker

SACE XT4L (120 kA) Ekip LS/I - Front terminals (F)

Size	lu	Trip units	In	Type	3 poles	4 poles
					Code	Code
XT4	160	Ekip LS/I	40	XT4L 160 Ekip LS/I In=40A	Only available with the Breaking Part + Trip unit solution	
			63	XT4L 160 Ekip LS/I In=63A		
			100	XT4L 160 Ekip LS/I In=100A		
			160	XT4L 160 Ekip LS/I In=160A		
XT4	250	Ekip LS/I	250	XT4L 250 Ekip LS/I In=250A	Only available with the Breaking Part + Trip unit solution	

SACE XT4L (120 kA) Ekip I - Front terminals (F)

Size	lu	Trip units	In	Type	3 poles	4 poles
					Code	Code
XT4	160	Ekip I	40	XT4L 160 Ekip I In=40A	Only available with the Breaking Part + Trip unit solution	
			63	XT4L 160 Ekip I In=63A		
			100	XT4L 160 Ekip I In=100A		
			160	XT4L 160 Ekip I In=160A		
XT4	250	Ekip I	250	XT4L 250 Ekip I In=250A	Only available with the Breaking Part + Trip unit solution	

SACE XT4L (120 kA) Ekip LSI - Front terminals (F)

Size	lu	Trip units	In	Type	3 poles	4 poles
					Code	Code
XT4	160	Ekip LSI	40	XT4L 160 Ekip LSI In=40A	Only available with the Breaking Part + Trip unit solution	
			63	XT4L 160 Ekip LSI In=63A		
			100	XT4L 160 Ekip LSI In=100A		
			160	XT4L 160 Ekip LSI In=160A		
XT4	250	Ekip LSI	250	XT4L 250 Ekip LSI In=250A	Only available with the Breaking Part + Trip unit solution	

SACE XT4L (120 kA) Ekip LSIG - Front terminals (F)

Size	lu	Trip units	In	Type	3 poles	4 poles
					Code	Code
XT4	160	Ekip LSIG	40	XT4L 160 Ekip LSIG In=40A	Only available with the Breaking Part + Trip unit solution	
			63	XT4L 160 Ekip LSIG In=63A		
			100	XT4L 160 Ekip LSIG In=100A		
			160	XT4L 160 Ekip LSIG In=160A		
XT4	250	Ekip LSIG	250	XT4L 250 Ekip LSIG In=250A	Only available with the Breaking Part + Trip unit solution	

Ordering codes for XT4

Automatic circuit-breakers



XT4 - circuit-breaker

SACE XT4L (120 kA) Ekip Dip LIG - Front terminals (F)

Size	lu	Trip units	In	Type	3 poles	4 poles
					Code	Code
XT4	160	Ekip Dip LIG	40	XT4L 160 Ekip Dip LIG In=40A	Only available with the Breaking Part + Trip unit solution	
			63	XT4L 160 Ekip Dip LIG In=63A		
			100	XT4L 160 Ekip Dip LIG In=100A		
			160	XT4L 160 Ekip Dip LIG In=160A		
XT4	250	Ekip Dip LIG	250	XT4L 250 Ekip Dip LIG In=250A	Only available with the Breaking Part + Trip unit solution	

Motor protection circuit-breakers

SACE XT4L (120 kA) MA - Front terminals (F)

Size	lu	Trip units	In	Type	3 poles	4 poles
					Code	Code
XT4	160	MA	10	XT4L 160 MA 10 Im=50...100	1SDA068451R1	
			12,5	XT4L 160 MA 12,5 Im=62,5...125	1SDA068452R1	
			20	XT4L 160 MA 20 Im=100...200	1SDA068453R1	
			32	XT4L 160 MA 32 Im=160...320	1SDA068454R1	
			52	XT4L 160 MA 52 Im=260...520	1SDA068455R1	
			80	XT4L 160 MA 80 Im=400...800		Only available with the Breaking Part + Trip unit solution
			100	XT4L 160 MA 100 Im=500...1000		
			125	XT4L 160 MA 125 Im=625...1160		
			160	XT4L 160 MA 160 Im=800...1600		
XT4	250	MA	200	XT4L 250 MA 200 Im=1000...2000	Only available with the Breaking Part + Trip unit solution	



XT4 - circuit-breaker

Distribution circuit-breakers



XT4 - circuit-breaker

SACE XT4V (150 kA) TMD/TMA - Front terminals (F)

Size	lu	Trip units	In	Type	3 poles	4 poles
					Code	Code
XT4	160	TMD	16	XT4V 160 TMD 16-300	Only available with the Breaking Part + Trip unit solution	
			20	XT4V 160 TMD 20-300		
			25	XT4V 160 TMD 25-300		
			32	XT4V 160 TMD 32-320		
XT4	160	TMA	40	XT4V 160 TMA 40-400	Only available with the Breaking Part + Trip unit solution	
			50	XT4V 160 TMA 50-500		
			63	XT4V 160 TMA 63-630		
			80	XT4V 160 TMA 80-800		
			100	XT4V 160 TMA 100-1000		
			125	XT4V 160 TMA 125-1250		
			160	XT4V 160 TMA 160-1600		
			125	XT4V 160 TMA 125-1250 InN=50%		
XT4	250	TMA	200	XT4V 250 TMA 200-2000	Only available with the Breaking Part + Trip unit solution	
			225	XT4V 250 TMA 225-2250		
			250	XT4V 250 TMA 250-2500		
			200	XT4V 250 TMA 200-2000 InN=50%		
			225	XT4V 250 TMA 225-2250 InN=50%		
			250	XT4V 250 TMA 250-2500 InN=50%		

SACE XT4V (150 kA) Ekip LS/I - Front terminals (F)

Size	lu	Trip units	In	Type	3 poles	4 poles
					Code	Code
XT4	160	Ekip LS/I	40	XT4V 160 Ekip LS/I In=40A	Only available with the Breaking Part + Trip unit solution	
			63	XT4V 160 Ekip LS/I In=63A		
			100	XT4V 160 Ekip LS/I In=100A		
			160	XT4V 160 Ekip LS/I In=160A		
XT4	250	Ekip LS/I	250	XT4V 250 Ekip LS/I In=250A	Only available with the Breaking Part + Trip unit solution	

SACE XT4V (150 kA) Ekip I - Front terminals (F)

Size	lu	Trip units	In	Type	3 poles	4 poles
					Code	Code
XT4	160	Ekip I	40	XT4V 160 Ekip I In=40A	Only available with the Breaking Part + Trip unit solution	
			63	XT4V 160 Ekip I In=63A		
			100	XT4V 160 Ekip I In=100A		
			160	XT4V 160 Ekip I In=160A		
XT4	250	Ekip I	250	XT4V 250 Ekip I In=250A	Only available with the Breaking Part + Trip unit solution	

Ordering codes for XT4

Automatic circuit-breakers



XT4 - circuit-breaker

SACE XT4V (150 kA) Ekip LSI - Front terminals (F)

Size	lu	Trip units	In	Type	3 poles	4 poles
					Code	Code
XT4	160	Ekip LSI	40	XT4V 160 Ekip LSI In=40A	Only available with the Breaking Part + Trip unit solution	
			63	XT4V 160 Ekip LSI In=63A		
			100	XT4V 160 Ekip LSI In=100A		
			160	XT4V 160 Ekip LSI In=160A		
XT4	250	Ekip LSI	250	XT4V 250 Ekip LSI In=250A	Only available with the Breaking Part + Trip unit solution	

SACE XT4V (150 kA) Ekip LSIG - Front terminals (F)

Size	lu	Trip units	In	Type	3 poles	4 poles
					Code	Code
XT4	160	Ekip LSIG	40	XT4V 160 Ekip LSIG In=40A	Only available with the Breaking Part + Trip unit solution	
			63	XT4V 160 Ekip LSIG In=63A		
			100	XT4V 160 Ekip LSIG In=100A		
			160	XT4V 160 Ekip LSIG In=160A		
XT4	250	Ekip LSIG	250	XT4V 250 Ekip LSIG In=250A	Only available with the Breaking Part + Trip unit solution	

SACE XT4V (150 kA) Ekip Dip LIG - Front terminals (F)

Size	lu	Trip units	In	Type	3 poles	4 poles
					Code	Code
XT4	160	Ekip Dip LIG	40	XT4V 160 Ekip Dip LIG In=40A	Only available with the Breaking Part + Trip unit solution	
			63	XT4V 160 Ekip Dip LIG In=63A		
			100	XT4V 160 Ekip Dip LIG In=100A		
			160	XT4V 160 Ekip Dip LIG In=160A		
XT4	250	Ekip Dip LIG	250	XT4V 250 Ekip Dip LIG In=250A	Only available with the Breaking Part + Trip unit solution	

Motor protection circuit-breakers



XT4 - circuit-breaker

SACE XT4V (150 kA) MA - Front terminals (F)

Size	lu	Trip units	In	Type	3 poles	4 poles
					Code	Code
XT4	160	MA	10	XT4V 160 MA 10 Im=50...100	1SDA101954R1	
			12,5	XT4V 160 MA 12,5 Im=62,5...125	1SDA101955R1	
			20	XT4V 160 MA 20 Im=100...200	1SDA107704R1	
			32	XT4V 160 MA 32 Im=160...320	1SDA107705R1	
			52	XT4V 160 MA 52 Im=260...520	1SDA107706R1	
			80	XT4V 160 MA 80 Im=400...800		
			100	XT4V 160 MA 100 Im=500...1000		Only available with the Breaking Part + Trip unit solution
			125	XT4V 160 MA 125 Im=625...1160		
			160	XT4V 160 MA 160 Im=800...1600		
XT4	250	MA	200	XT4V 250 MA 200 Im=1000...2000		Only available with the Breaking Part + Trip unit solution

Distribution circuit-breakers



XT4 - circuit-breaker

SACE XT4X (200 kA) TMD/TMA - Front terminals (F)

Size	lu	Trip units	In	Type	3 poles	4 poles
					Code	Code
XT4	160	TMA	40	XT4X 160 TMA 40-400		Only available with the Breaking Part + Trip unit solution
			50	XT4X 160 TMA 50-500		
			63	XT4X 160 TMA 63-630		
			80	XT4X 160 TMA 80-800		
			100	XT4X 160 TMA 100-1000		
			125	XT4X 160 TMA 125-1250		
			160	XT4X 160 TMA 160-1600		
			125	XT4X 160 TMA 125-1250 InN=50%		
			160	XT4X 160 TMA 160-1600 InN=50%		
			XT4	250	TMA	
225	XT4X 250 TMA 225-2250					
250	XT4X 250 TMA 250-2500					
200	XT4X 250 TMA 200-2000 InN=50%					
225	XT4X 250 TMA 225-2250 InN=50%					
250	XT4X 250 TMA 250-2500 InN=50%					

Ordering codes for XT4

Automatic circuit-breakers



XT4 - circuit-breaker

SACE XT4X (200 kA) Ekip LS/I - Front terminals (F)

Size	lu	Trip units	In	Type	3 poles	4 poles
					Code	Code
XT4	160	Ekip LS/I	40	XT4X 160 Ekip LS/I In=40A	Only available with the Breaking Part + Trip unit solution	
			63	XT4X 160 Ekip LS/I In=63A		
			100	XT4X 160 Ekip LS/I In=100A		
			160	XT4X 160 Ekip LS/I In=160A		
XT4	250	Ekip LS/I	250	XT4X 250 Ekip LS/I In=250A	Only available with the Breaking Part + Trip unit solution	

SACE XT4X (200 kA) Ekip I - Front terminals (F)

Size	lu	Trip units	In	Type	3 poles	4 poles
					Code	Code
XT4	160	Ekip I	40	XT4X 160 Ekip I In=40A	Only available with the Breaking Part + Trip unit solution	
			63	XT4X 160 Ekip I In=63A		
			100	XT4X 160 Ekip I In=100A		
			160	XT4X 160 Ekip I In=160A		
XT4	250	Ekip I	250	XT4X 250 Ekip I In=250A	Only available with the Breaking Part + Trip unit solution	

SACE XT4X (200 kA) Ekip LSI - Front terminals (F)

Size	lu	Trip units	In	Type	3 poles	4 poles
					Code	Code
XT4	160	Ekip LSI	40	XT4X 160 Ekip LSI In=40A	Only available with the Breaking Part + Trip unit solution	
			63	XT4X 160 Ekip LSI In=63A		
			100	XT4X 160 Ekip LSI In=100A		
			160	XT4X 160 Ekip LSI In=160A		
XT4	250	Ekip LSI	250	XT4X 250 Ekip LSI In=250A	Only available with the Breaking Part + Trip unit solution	

SACE XT4X (200 kA) Ekip LSIG - Front terminals (F)

Size	lu	Trip units	In	Type	3 poles	4 poles
					Code	Code
XT4	160	Ekip LSIG	40	XT4X 160 Ekip LSIG In=40A	Only available with the Breaking Part + Trip unit solution	
			63	XT4X 160 Ekip LSIG In=63A		
			100	XT4X 160 Ekip LSIG In=100A		
			160	XT4X 160 Ekip LSIG In=160A		
XT4	250	Ekip LSIG	250	XT4X 250 Ekip LSIG In=250A	Only available with the Breaking Part + Trip unit solution	



XT4 - circuit-breaker

SACE XT4X (200 kA) Ekip Dip LIG - Front terminals (F)

Size	lu	Trip units	In	Type	3 poles	4 poles
					Code	Code
XT4	160	Ekip Dip LIG	40	XT4X 160 Ekip Dip LIG In=40A	Only available with the Breaking Part + Trip unit solution	
			63	XT4X 160 Ekip Dip LIG In=63A		
			100	XT4X 160 Ekip Dip LIG In=100A		
			160	XT4X 160 Ekip Dip LIG In=160A		
XT4	250	Ekip Dip LIG	250	XT4X 250 Ekip Dip LIG In=250A	Only available with the Breaking Part + Trip unit solution	

Motor protection circuit-breakers

SACE XT4X(200 kA) MA - Front terminals (F)



XT4 - circuit-breaker

Size	lu	Trip units	In	Type	3 poles	4 poles
					Code	Code
XT4	160	MA	10	XT4X 160 MA 10 Im=50...100	1SDA101956R1	
			12,5	XT4X 160 MA 12,5 Im=62,5...125	1SDA101957R1	
			20	XT4X 160 MA 20 Im=100...200	1SDA107707R1	
			32	XT4X 160 MA 32 Im=160...320	1SDA107708R1	
			52	XT4X 160 MA 52 Im=260...520	1SDA107709R1	
			80	XT4X 160 MA 80 Im=400...800		Only available with the Breaking Part + Trip unit solution
			100	XT4X 160 MA 100 Im=500...1000		
			125	XT4X 160 MA 125 Im=625...1160		
160	XT4X 160 MA 160 Im=800...1600					
XT4	250	MA	200	XT4X 250 MA 200 Im=1000...2000	Only available with the Breaking Part + Trip unit solution	

Ordering codes for XT4

Switch-disconnectors



—
XT4D -
switch-disconnector

SACE XT4 - Switch-disconnectors

Size	Iu	Type	3 poles	4 poles
			Code	Code
XT4D	250	XT4D 250	1SDA068212R1	1SDA068213R1

Ordering codes for XT4

Breaking part



—
XT4 - breaking part

SACE XT4 - Breaking part

Size	Iu	Icu (415 V)	Type	3 poles	4 poles
				Code	Code
XT4	160	36	XT4N 160 Breaking part	1SDA068289R1	1SDA068294R1
	250	36	XT4N 250 Breaking part	1SDA068173R1	1SDA068178R1
	160	50	XT4S 160 Breaking part	1SDA068290R1	1SDA068295R1
	250	50	XT4S 250 Breaking part	1SDA068174R1	1SDA068179R1
	160	70	XT4H 160 Breaking part	1SDA068291R1	1SDA068296R1
	250	70	XT4H 250 Breaking part	1SDA068175R1	1SDA068180R1
	160	120	XT4L 160 Breaking part	1SDA068292R1	1SDA068297R1
	250	120	XT4L 250 Breaking part	1SDA068176R1	1SDA068181R1
	160	150	XT4V 160 Breaking part	1SDA100261R1	1SDA100263R1
	250	150	XT4V 250 Breaking part	1SDA100262R1	1SDA100264R1
	160	200	XT4X 160 Breaking part	1SDA100265R1	1SDA100267R1
	250	200	XT4X 250 Breaking part	1SDA100266R1	1SDA100268R1

Ordering codes for XT4

Trip units

Trip units - Distribution protection

Size	Type	3 poles	4 poles
		Code	Code
XT4	TMD 16-300	1SDA067377R1	1SDA067465R1
	TMD 20-300	1SDA067378R1	1SDA067468R1
	TMD 25-300	1SDA067379R1	1SDA067469R1
	TMD 32-320	1SDA067380R1	1SDA067470R1
	TMA 40-400	1SDA067381R1	1SDA067471R1
	TMA 50-500	1SDA067382R1	1SDA067472R1
	TMA 63-630	1SDA067383R1	1SDA067473R1
	TMA 80-800	1SDA067384R1	1SDA067474R1
	TMA 100-1000	1SDA067385R1	1SDA067475R1
	TMA 125-1250	1SDA067386R1	1SDA067481R1
	TMA 160-1600	1SDA067387R1	1SDA067482R1
	TMA 125-1250 InN=50%		1SDA067476R1
	TMA 160-1600 InN=50%		1SDA067477R1
	TMA 200-2000	1SDA067388R1	1SDA067483R1
	TMA 225-2250	1SDA067389R1	1SDA067484R1
	TMA 250-2500	1SDA067390R1	1SDA067485R1
	TMA 200-2000 InN=50%		1SDA067478R1
	TMA 225-2250 InN=50%		1SDA067479R1
	TMA 250-2500 InN=50%		1SDA067480R1
	Ekip LS/I In=40A	1SDA067498R1	1SDA067518R1
	Ekip LS/I In=63A	1SDA067499R1	1SDA067519R1
	Ekip LS/I In=100A	1SDA067500R1	1SDA067520R1
	Ekip LS/I In=160A	1SDA067501R1	1SDA067521R1
	Ekip LS/I In=250A	1SDA067502R1	1SDA067522R1
	Ekip LSI In=40A	1SDA067508R1	1SDA067528R1
	Ekip LSI In=63A	1SDA067509R1	1SDA067529R1
	Ekip LSI In=100A	1SDA067510R1	1SDA067530R1
	Ekip LSI In=160A	1SDA067511R1	1SDA067531R1
	Ekip LSI In=250A	1SDA067512R1	1SDA067532R1
	Ekip LSIG In=40A	1SDA067513R1	1SDA067533R1
	Ekip LSIG In=63A	1SDA067514R1	1SDA067534R1
	Ekip LSIG In=100A	1SDA067515R1	1SDA067535R1
	Ekip LSIG In=160A	1SDA067516R1	1SDA067536R1
	Ekip LSIG In=250A	1SDA067517R1	1SDA067537R1
	Ekip Dip LIG In=40A	1SDA100303R1	1SDA100339R1
	Ekip Dip LIG In=63A	1SDA100304R1	1SDA100340R1
	Ekip Dip LIG In=100A	1SDA100305R1	1SDA100341R1
	Ekip Dip LIG In=160A	1SDA100306R1	1SDA100342R1
	Ekip Dip LIG In=250A	1SDA100307R1	1SDA100343R1

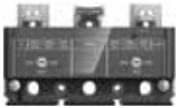

Thermal magnetic trip unit

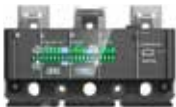

Dip trip unit



Touch trip unit

Trip units - Distribution protection

Size	Type	3 poles	4 poles
		Code	Code
XT4	Ekip Touch LSI In=100A	1SDA100279R1	1SDA100318R1
	Ekip Touch LSI In=160A	1SDA100280R1	1SDA100319R1
	Ekip Touch LSI In=250A	1SDA100281R1	1SDA100320R1
	Ekip Touch LSIG In=100A	1SDA100282R1	1SDA100321R1
	Ekip Touch LSIG In=160A	1SDA100283R1	1SDA100322R1
	Ekip Touch LSIG In=250A	1SDA100284R1	1SDA100323R1
	Ekip Touch Measuring LSI In=100A	1SDA100285R1	1SDA100324R1
	Ekip Touch Measuring LSI In=160A	1SDA100286R1	1SDA100325R1
	Ekip Touch Measuring LSI In=250A	1SDA100287R1	1SDA100326R1
	Ekip Touch Measuring LSIG In=100A	1SDA100288R1	1SDA100327R1
	Ekip Touch Measuring LSIG In=160A	1SDA100289R1	1SDA100328R1
	Ekip Touch Measuring LSIG In=250A	1SDA100290R1	1SDA100329R1
	Ekip Hi-Touch LSI In=100A	1SDA100291R1	1SDA100330R1
	Ekip Hi-Touch LSI In=160A	1SDA100292R1	1SDA100331R1
	Ekip Hi-Touch LSI In=250A	1SDA100293R1	1SDA100332R1
	Ekip Hi-Touch LSIG In=100A	1SDA100294R1	1SDA100333R1
	Ekip Hi-Touch LSIG In=160A	1SDA100295R1	1SDA100334R1
	Ekip Hi-Touch LSIG In=250A	1SDA100296R1	1SDA100335R1

Ordering codes for XT4

Trip units

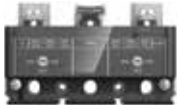

—
Thermal magnetic
trip unit



—
Touch trip unit

Trip units - Motor protection

Size	Type	3 poles	4 poles
		Code	Code
XT4	MA 80 Im=400...800	1SDA067493R1	
	MA 100 Im=600...1000	1SDA067494R1	
	MA 125 Im=625...1250	1SDA067495R1	
	MA 160 Im=800...1600	1SDA067496R1	
	MA 200 Im=1000...2000	1SDA067497R1	
	Ekip I In=40A	1SDA067503R1	
	Ekip I In=63A	1SDA067504R1	
	Ekip I In=100A	1SDA067505R1	
	Ekip I In=160A	1SDA067506R1	
	Ekip I In=250A	1SDA067507R1	
	Ekip M-LIU In=40A	1SDA068028R1	
	Ekip M-LIU In=63A	1SDA068029R1	
	Ekip M-LIU In=100A	1SDA068030R1	
	Ekip M-LIU In=160A	1SDA068031R1	
	Ekip M-LRIU In=40A	1SDA068033R1	
	Ekip M-LRIU In=63A	1SDA068034R1	
	Ekip M-LRIU In=100A	1SDA068035R1	
	Ekip M-LRIU In=160A	1SDA068036R1	
	Ekip M-LRIU In=200A	1SDA068037R1	
	Ekip M Touch LRIU In=100A XT4 3p	1SDA100297R1	
	Ekip M Touch LRIU In=160A XT4 3p	1SDA100298R1	
	Ekip M Touch LRIU In=250A XT4 3p	1SDA100299R1	

Trip units - Generator protection

Size	Type	3 poles	4 poles
		Code	Code
XT4	Ekip G-LS/I In=40A	1SDA068038R1	1SDA068043R1
	Ekip G-LS/I In=63A	1SDA068039R1	1SDA068044R1
	Ekip G-LS/I In=100A	1SDA068040R1	1SDA068045R1
	Ekip G-LS/I In=160A	1SDA068041R1	1SDA068046R1
	Ekip G-LS/I In=250A	1SDA068042R1	1SDA068047R1

Ordering codes for XT4

Breaking part + trip unit solution



XT4 Breaking part



Thermal-Magnetic Trip unit



Ekip Dip Trip Unit



Thermal-Magnetic Trip unit

Breaking Part	Icu	N (36 kA)		S (50 kA)		H (70 kA)		L (120 kA)		V (150 kA)		X (200 kA)	
		Poles	Iu										
	160	068289	068290	068291	068292	100261	100265						
	250	068173	068174	068175	068176	100262	100266						
	160	068178	068179	068180	068181	100263	100267						
	250	068294	068295	068296	068297	100264	100268						

Trip units	In	Poles															
		16	20	25	32	40	50	52	63	80	100	125	160	200	225	250	
TMD	3	067377**067378**067379**067380**															
	4	067465**067468**067469**067470**															
TMA	3				067381	067382		067383	067384	067385	067386	067387	067388	067389	067390		
	4				067471	067472		067473	067474	067475	067481*	067482*	067483*	067484*	067485*		
Ekip LS/I	3				067498		067499		067500		067501		067502				
	4				067518		067519		067520		067521		067522				
Ekip I	3				067503		067504		067505		067506		067507				
	4				067523		067524		067525		067526		067527				
Ekip LSI	3				067508		067509		067510		067511		067512				
	4				067528		067529		067530		067531		067532				
Ekip LSIG	3				067513		067514		067515		067516		067517				
	4				067533		067534		067535		067536		067537				
Ekip Dip LIG	3				100303		100304		100305		100306		100307				
	4				100339		100340		100341		100342		100343				
Ekip Touch LSI	3								100279		100280		100281				
	4								100318		100319		100320				
Ekip Touch LSIG	3								100282		100283		100284				
	4								100321		100322		100323				
Ekip Touch Measuring LSI	3								100285		100286		100287				
	4								100324		100325		100326				
Ekip Touch Measuring LSIG	3								100288		100289		100290				
	4								100327		100328		100329				
Ekip Hi-Touch LSI	3								100291		100292		100293				
	4								100330		100331		100332				
Ekip Hi-Touch LSIG	3								100294		100295		100296				
	4								100333		100334		100335				
MA	3							067493	067494	067495	067496	067497					
Ekip M LIU	3				068028		068029		068030		068031						
Ekip M LRIU					068033		068034		068035		068036	068037					
Ekip M Touch LRIU	3								100297		100298		100299				
Ekip G-LS/I	3				068038		068039		068040		068041		068042				
	4				068043		068044		068045		068046		068047				

* InN=100%. Combinations available for InN=50% too. For ordering codes, please see in reference pages 'trip Units'

** Not available with breaking part X

Note: when a single code for the complete circuit-breaker is not available, please configure the breaking part code with the trip unit code to order a factory-assembled circuit-breaker.

Ordering codes for XT5

Automatic circuit-breakers

Distribution circuit-breakers

SACE XT5N (36 kA) TMA - Front terminals (F)



XT5 - circuit-breaker

Size	lu	Trip units	In	Type	3 poles	4 poles
					Code	Code
XT5	400	TMA	320	XT5N 400 TMA 320-3200	1SDA100344R1	1SDA100383R1
			400	XT5N 400 TMA 400-4000	1SDA100345R1	1SDA100385R1
			320	XT5N 400 TMA 320-3200 InN=50%		1SDA100382R1
			400	XT5N 400 TMA 400-4000 InN=50%		1SDA100384R1
XT5	630	TMA	500	XT5N 630 TMA 500-5000	1SDA100346R1	1SDA100387R1
			630	XT5N 630 TMA 630-6300	1SDA100347R1	1SDA100389R1
			500	XT5N 630 TMA 500-5000 InN=50%		1SDA100386R1
			630	XT5N 630 TMA 630-6300 InN=50%		1SDA100388R1

SACE XT5N (36 kA) Ekip Dip LS/I - Front terminals (F)

Size	lu	Trip units	In	Type	3 poles	4 poles
					Code	Code
XT5	400	Ekip Dip LS/I	250	XT5N 400 Ekip Dip LS/I In=250	1SDA100352R1	1SDA100394R1
			320	XT5N 400 Ekip Dip LS/I In=320	1SDA100353R1	1SDA100395R1
			400	XT5N 400 Ekip Dip LS/I In=400	1SDA100354R1	1SDA100396R1
XT5	630	Ekip Dip LS/I	630	XT5N 630 Ekip Dip LS/I In=630	1SDA100355R1	1SDA100397R1

SACE XT5N (36 kA) Ekip Dip LSI - Front terminals (F)

Size	lu	Trip units	In	Type	3 poles	4 poles
					Code	Code
XT5	400	Ekip Dip LSI	250	XT5N 400 Ekip Dip LSI In=250	1SDA100356R1	1SDA100398R1
			320	XT5N 400 Ekip Dip LSI In=320	1SDA100357R1	1SDA100399R1
			400	XT5N 400 Ekip Dip LSI In=400	1SDA100358R1	1SDA100400R1
XT5	630	Ekip Dip LSI	630	XT5N 630 Ekip Dip LSI In=630	1SDA100359R1	1SDA100401R1

SACE XT5N (36 kA) Ekip Dip LSIG - Front terminals (F)

Size	lu	Trip units	In	Type	3 poles	4 poles
					Code	Code
XT5	400	Ekip Dip LSIG	250	XT5N 400 Ekip Dip LSIG In=250	1SDA100360R1	1SDA100402R1
			320	XT5N 400 Ekip Dip LSIG In=320	1SDA100361R1	1SDA100403R1
			400	XT5N 400 Ekip Dip LSIG In=400	1SDA100362R1	1SDA100404R1
XT5	630	Ekip Dip LSIG	630	XT5N 630 Ekip Dip LSIG In=630	1SDA100363R1	1SDA100405R1

SACE XT5N (36 kA) Ekip Dip LIG - Front terminals (F)

Size	lu	Trip units	In	Type	3 poles	4 poles
					Code	Code
XT5	400	Ekip Dip LIG	250	XT5N 400 Ekip Dip LIG In=250	1SDA100378R1	1SDA100410R1
			320	XT5N 400 Ekip Dip LIG In=320	1SDA100379R1	1SDA100411R1
			400	XT5N 400 Ekip Dip LIG In=400	1SDA100380R1	1SDA100412R1
XT5	630	Ekip Dip LIG	630	XT5N 630 Ekip Dip LIG In=630	1SDA100381R1	1SDA100413R1

Motor protection circuit-breakers

SACE XT5N (36 kA) MA - Front terminals (F)

Size	lu	Trip units	In	Type	3 poles	4 poles
					Code	Code
XT5	400	MA	320	XT5N 400 MA 320-3200	1SDA100364R1	
			400	XT5N 400 MA 400-4000	1SDA100365R1	
XT5	630	MA	500	XT5N 630 MA 500-5000	1SDA100366R1	

SACE XT5N (36 kA) Ekip M Dip I - Front terminals (F)

Size	lu	Trip units	In	Type	3 poles	4 poles
					Code	Code
XT5	400	Ekip M Dip I	320	XT5N 400 Ekip M Dip I In=320A	1SDA100367R1	
			400	XT5N 400 Ekip M Dip I In=400A	1SDA100368R1	
XT5	630	Ekip M Dip I	630	XT5N 630 Ekip M Dip I In=630A	1SDA100369R1	

SACE XT5N (36 kA) Ekip M Dip LIU - Front terminals (F)

Size	lu	Trip units	In	Type	3 poles	4 poles
					Code	Code
XT5	400	Ekip M Dip LIU	250	XT5N 400 Ekip M Dip LIU In=250A	1SDA100370R1	
			320	XT5N 400 Ekip M Dip LIU In=320A	1SDA100371R1	
			400	XT5N 400 Ekip M Dip LIU In=400A	1SDA100372R1	
XT5	630	Ekip M Dip LIU	500	XT5N 630 Ekip M Dip LIU In=500A	1SDA100373R1	

Generator protection circuit-breakers

SACE XT5N (36 kA) TMG - Front terminals (F)

Size	lu	Trip units	In	Type	3 poles	4 poles
					Code	Code
XT5	400	TMG	320	XT5N 400 TMG 320-1600	1SDA100374R1	1SDA100406R1
			400	XT5N 400 TMG 400-2000	1SDA100375R1	1SDA100407R1
XT5	630	TMG	500	XT5N 630 TMG 500-2500	1SDA100376R1	1SDA100408R1
			630	XT5N 630 TMG 630-3150	1SDA100377R1	1SDA100409R1



—
XT5 - circuit-breaker



—
XT5 - circuit-breaker

Ordering codes for XT5

Automatic circuit-breakers

Distribution circuit-breakers

SACE XT5S (50 kA) TMA - Front terminals (F)



XT5 - circuit-breaker

Size	lu	Trip units	In	Type	3 poles	4 poles
					Code	Code
XT5	400	TMA	320	XT5S 400 TMA 320-3200	1SDA100414R1	1SDA100453R1
			400	XT5S 400 TMA 400-4000	1SDA100415R1	1SDA100455R1
			320	XT5S 400 TMA 320-3200 InN=50%		1SDA100452R1
			400	XT5S 400 TMA 400-4000 InN=50%		1SDA100454R1
XT5	630	TMA	500	XT5S 630 TMA 500-5000	1SDA100416R1	1SDA100457R1
			630	XT5S 630 TMA 630-6300	1SDA100417R1	1SDA100459R1
			500	XT5S 630 TMA 500-5000 InN=50%		1SDA100456R1
			630	XT5S 630 TMA 630-6300 InN=50%		1SDA100458R1

SACE XT5S (50 kA) Ekip Dip LS/I - Front terminals (F)

Size	lu	Trip units	In	Type	3 poles	4 poles
					Code	Code
XT5	400	Ekip Dip LS/I	250	XT5S 400 Ekip Dip LS/I In=250	1SDA100422R1	1SDA100464R1
			320	XT5S 400 Ekip Dip LS/I In=320	1SDA100423R1	1SDA100465R1
			400	XT5S 400 Ekip Dip LS/I In=400	1SDA100424R1	1SDA100466R1
XT5	630	Ekip Dip LS/I	630	XT5S 630 Ekip Dip LS/I In=630	1SDA100425R1	1SDA100467R1

SACE XT5S (50 kA) Ekip Dip LSI - Front terminals (F)

Size	lu	Trip units	In	Type	3 poles	4 poles
					Code	Code
XT5	400	Ekip Dip LSI	250	XT5S 400 Ekip Dip LSI In=250	1SDA100426R1	1SDA100468R1
			320	XT5S 400 Ekip Dip LSI In=320	1SDA100427R1	1SDA100469R1
			400	XT5S 400 Ekip Dip LSI In=400	1SDA100428R1	1SDA100470R1
XT5	630	Ekip Dip LSI	630	XT5S 630 Ekip Dip LSI In=630	1SDA100429R1	1SDA100471R1

SACE XT5S (50 kA) Ekip Dip LSIG - Front terminals (F)

Size	lu	Trip units	In	Type	3 poles	4 poles
					Code	Code
XT5	400	Ekip Dip LSIG	250	XT5S 400 Ekip Dip LSIG In=250	1SDA100430R1	1SDA100472R1
			320	XT5S 400 Ekip Dip LSIG In=320	1SDA100431R1	1SDA100473R1
			400	XT5S 400 Ekip Dip LSIG In=400	1SDA100432R1	1SDA100474R1
XT5	630	Ekip Dip LSIG	630	XT5S 630 Ekip Dip LSIG In=630	1SDA100433R1	1SDA100475R1

SACE XT5S (50 kA) Ekip Dip LIG - Front terminals (F)

Size	lu	Trip units	In	Type	3 poles	4 poles
					Code	Code
XT5	400	Ekip Dip LIG	250	XT5S 400 Ekip Dip LIG In=250	1SDA100448R1	1SDA100480R1
			320	XT5S 400 Ekip Dip LIG In=320	1SDA100449R1	1SDA100481R1
			400	XT5S 400 Ekip Dip LIG In=400	1SDA100450R1	1SDA100482R1
XT5	630	Ekip Dip LIG	630	XT5S 630 Ekip Dip LIG In=630	1SDA100451R1	1SDA100483R1

Motor protection circuit-breakers



—
XT5 - circuit-breaker

SACE XT5S (50 kA) MA - Front terminals (F)

Size	lu	Trip units	In	Type	3 poles	4 poles
					Code	Code
XT5	400	MA	320	XT5S 400 MA 320-3200	1SDA100434R1	
			400	XT5S 400 MA 400-4000	1SDA100435R1	
XT5	630	MA	500	XT5S 630 MA 500-5000	1SDA100436R1	

SACE XT5S (50 kA) Ekip M Dip I - Front terminals (F)

Size	lu	Trip units	In	Type	3 poles	4 poles
					Code	Code
XT5	400	Ekip M Dip I	320	XT5S 400 Ekip M Dip I In=320A	1SDA100437R1	
			400	XT5S 400 Ekip M Dip I In=400A	1SDA100438R1	
XT5	630	Ekip M Dip I	630	XT5S 630 Ekip M Dip I In=630A	1SDA100439R1	

SACE XT5S (50 kA) Ekip M Dip LIU - Front terminals (F)

Size	lu	Trip units	In	Type	3 poles	4 poles
					Code	Code
XT5	400	Ekip M Dip LIU	250	XT5S 400 Ekip M Dip LIU In=250A	1SDA100440R1	
			320	XT5S 400 Ekip M Dip LIU In=320A	1SDA100441R1	
			400	XT5S 400 Ekip M Dip LIU In=400A	1SDA100442R1	
XT5	630	Ekip M Dip LIU	500	XT5S 630 Ekip M Dip LIU In=500A	1SDA100443R1	

Generator protection circuit-breakers



—
XT5 - circuit-breaker

SACE XT5S (50 kA) TMG - Front terminals (F)

Size	lu	Trip units	In	Type	3 poles	4 poles
					Code	Code
XT5	400	TMG	320	XT5S 400 TMG 320-1600	1SDA100444R1	1SDA100476R1
			400	XT5S 400 TMG 400-2000	1SDA100445R1	1SDA100477R1
XT5	630	TMG	500	XT5S 630 TMG 500-2500	1SDA100446R1	1SDA100478R1
			630	XT5S 630 TMG 630-3150	1SDA100447R1	1SDA100479R1

Ordering codes for XT5

Automatic circuit-breakers

Distribution circuit-breakers

SACE XT5H (70 kA) TMA - Front terminals (F)



XT5 - circuit-breaker

Size	lu	Trip units	In	Type	3 poles	4 poles
					Code	Code
XT5	400	TMA	320	XT5H 400 TMA 320-3200	1SDA100484R1	1SDA100519R1
			400	XT5H 400 TMA 400-4000	1SDA100485R1	1SDA100521R1
			320	XT5H 400 TMA 320-3200 InN=50%		1SDA100518R1
			400	XT5H 400 TMA 400-4000 InN=50%		1SDA100520R1
XT5	630	TMA	500	XT5H 630 TMA 500-5000	1SDA100486R1	1SDA100523R1
			630	XT5H 630 TMA 630-6300	1SDA100487R1	1SDA100525R1
			500	XT5H 630 TMA 500-5000 InN=50%		1SDA100522R1
			630	XT5H 630 TMA 630-6300 InN=50%		1SDA100524R1

SACE XT5H (70 kA) Ekip Dip LS/I - Front terminals (F)

Size	lu	Trip units	In	Type	3 poles	4 poles
					Code	Code
XT5	400	Ekip Dip LS/I	250	XT5H 400 Ekip Dip LS/I In=250	1SDA100488R1	1SDA100526R1
			320	XT5H 400 Ekip Dip LS/I In=320	1SDA100489R1	1SDA100527R1
			400	XT5H 400 Ekip Dip LS/I In=400	1SDA100490R1	1SDA100528R1
XT5	630	Ekip Dip LS/I	630	XT5H 630 Ekip Dip LS/I In=630	1SDA100491R1	1SDA100529R1

SACE XT5H (70 kA) Ekip Dip LSI - Front terminals (F)

Size	lu	Trip units	In	Type	3 poles	4 poles
					Code	Code
XT5	400	Ekip Dip LSI	250	XT5H 400 Ekip Dip LSI In=250	1SDA100492R1	1SDA100530R1
			320	XT5H 400 Ekip Dip LSI In=320	1SDA100493R1	1SDA100531R1
			400	XT5H 400 Ekip Dip LSI In=400	1SDA100494R1	1SDA100532R1
XT5	630	Ekip Dip LSI	630	XT5H 630 Ekip Dip LSI In=630	1SDA100495R1	1SDA100533R1

SACE XT5H (70 kA) Ekip Dip LSIG - Front terminals (F)

Size	lu	Trip units	In	Type	3 poles	4 poles
					Code	Code
XT5	400	Ekip Dip LSIG	250	XT5H 400 Ekip Dip LSIG In=250	1SDA100496R1	1SDA100534R1
			320	XT5H 400 Ekip Dip LSIG In=320	1SDA100497R1	1SDA100535R1
			400	XT5H 400 Ekip Dip LSIG In=400	1SDA100498R1	1SDA100536R1
XT5	630	Ekip Dip LSIG	630	XT5H 630 Ekip Dip LSIG In=630	1SDA100499R1	1SDA100537R1

SACE XT5H (70 kA) Ekip Dip LIG - Front terminals (F)

Size	lu	Trip units	In	Type	3 poles	4 poles
					Code	Code
XT5	400	Ekip Dip LIG	250	XT5H 400 Ekip Dip LIG In=250	1SDA100514R1	1SDA100542R1
			320	XT5H 400 Ekip Dip LIG In=320	1SDA100515R1	1SDA100543R1
			400	XT5H 400 Ekip Dip LIG In=400	1SDA100516R1	1SDA100544R1
XT5	630	Ekip Dip LIG	630	XT5H 630 Ekip Dip LIG In=630	1SDA100517R1	1SDA100545R1

Motor protection circuit-breakers



—
XT5 - circuit-breaker

SACE XT5H (70 kA) MA - Front terminals (F)

Size	lu	Trip units	In	Type	3 poles	4 poles
					Code	Code
XT5	400	MA	320	XT5H 400 MA 320-3200	1SDA100500R1	
			400	XT5H 400 MA 400-4000	1SDA100501R1	
XT5	630	MA	500	XT5H 630 MA 500-5000	1SDA100502R1	

SACE XT5H (70 kA) Ekip M Dip I - Front terminals (F)

Size	lu	Trip units	In	Type	3 poles	4 poles
					Code	Code
XT5	400	Ekip M Dip I	320	XT5H 400 Ekip M Dip I In=320A	1SDA100503R1	
			400	XT5H 400 Ekip M Dip I In=400A	1SDA100504R1	
XT5	630	Ekip M Dip I	630	XT5H 630 Ekip M Dip I In=630A	1SDA100505R1	

SACE XT5H (70 kA) Ekip M Dip LIU - Front terminals (F)

Size	lu	Trip units	In	Type	3 poles	4 poles
					Code	Code
XT5	400	Ekip M Dip LIU	250	XT5H 400 Ekip M Dip LIU In=250A	1SDA100506R1	
			320	XT5H 400 Ekip M Dip LIU In=320A	1SDA100507R1	
			400	XT5H 400 Ekip M Dip LIU In=400A	1SDA100508R1	
XT5	630	Ekip M Dip LIU	500	XT5H 630 Ekip M Dip LIU In=500A	1SDA100509R1	

Generator protection circuit-breakers



—
XT5 - circuit-breaker

SACE XT5H (70 kA) TMG - Front terminals (F)

Size	lu	Trip units	In	Type	3 poles	4 poles
					Code	Code
XT5	400	TMG	320	XT5H 400 TMG 320-1600	1SDA100510R1	1SDA100538R1
			400	XT5H 400 TMG 400-2000	1SDA100511R1	1SDA100539R1
XT5	630	TMG	500	XT5H 630 TMG 500-2500	1SDA100512R1	1SDA100540R1
			630	XT5H 630 TMG 630-3150	1SDA100513R1	1SDA100541R1

Ordering codes for XT5

Automatic circuit-breakers

Distribution circuit-breakers

SACE XT5L (120 kA) TMA - Front terminals (F)



XT5 - circuit-breaker

Size	lu	Trip units	In	Type	3 poles	4 poles
					Code	Code
XT5	400	TMA	320	XT5L 400 TMA 320-3200	Only available with the Breaking Part + Trip unit solution	
			400	XT5L 400 TMA 400-4000		
			320	XT5L 400 TMA 320-3200 InN=50%		
			400	XT5L 400 TMA 400-4000 InN=50%		
XT5	630	TMA	500	XT5L 630 TMA 500-5000		
			630	XT5L 630 TMA 630-6300		
			500	XT5L 630 TMA 500-5000 InN=50%		
			630	XT5L 630 TMA 630-6300 InN=50%		

SACE XT5L (120 kA) Ekip Dip LS/I - Front terminals (F)

Size	lu	Trip units	In	Type	3 poles	4 poles
					Code	Code
XT5	400	Ekip Dip LS/I	250	XT5L 400 Ekip Dip LS/I In=250	Only available with the Breaking Part + Trip unit solution	
			320	XT5L 400 Ekip Dip LS/I In=320		
			400	XT5L 400 Ekip Dip LS/I In=400		
XT5	630	Ekip Dip LS/I	630	XT5L 630 Ekip Dip LS/I In=630		

SACE XT5L (120 kA) Ekip Dip LSI - Front terminals (F)

Size	lu	Trip units	In	Type	3 poles	4 poles
					Code	Code
XT5	400	Ekip Dip LSI	250	XT5L 400 Ekip Dip LSI In=250	Only available with the Breaking Part + Trip unit solution	
			320	XT5L 400 Ekip Dip LSI In=320		
			400	XT5L 400 Ekip Dip LSI In=400		
XT5	630	Ekip Dip LSI	630	XT5L 630 Ekip Dip LSI In=630		

SACE XT5L (120 kA) Ekip Dip LSIG - Front terminals (F)

Size	lu	Trip units	In	Type	3 poles	4 poles
					Code	Code
XT5	400	Ekip Dip LSIG	250	XT5L 400 Ekip Dip LSIG In=250	Only available with the Breaking Part + Trip unit solution	
			320	XT5L 400 Ekip Dip LSIG In=320		
			400	XT5L 400 Ekip Dip LSIG In=400		
XT5	630	Ekip Dip LSIG	630	XT5L 630 Ekip Dip LSIG In=630		

SACE XT5L (120 kA) Ekip Dip LIG - Front terminals (F)

Size	lu	Trip units	In	Type	3 poles	4 poles
					Code	Code
XT5	400	Ekip Dip LIG	250	XT5L 400 Ekip Dip LIG In=250	Only available with the Breaking Part + Trip unit solution	
			320	XT5L 400 Ekip Dip LIG In=320		
			400	XT5L 400 Ekip Dip LIG In=400		
XT5	630	Ekip Dip LIG	630	XT5L 630 Ekip Dip LIG In=630		

Motor protection circuit-breakers



—
XT5 - circuit-breaker

SACE XT5L (120 kA) MA - Front terminals (F)

Size	lu	Trip units	In	Type	3 poles	4 poles
					Code	Code
XT5	400	MA	320	XT5L 400 MA 320-3200	Only available with the Breaking Part + Trip unit solution	
			400	XT5L 400 MA 400-4000		
XT5	630	MA	500	XT5L 630 MA 500-5000		

SACE XT5L (120 kA) Ekip M Dip I - Front terminals (F)

Size	lu	Trip units	In	Type	3 poles	4 poles
					Code	Code
XT5	400	Ekip M Dip I	320	XT5L 400 Ekip M Dip I In=320A	Only available with the Breaking Part + Trip unit solution	
			400	XT5L 400 Ekip M Dip I In=400A		
XT5	630	Ekip M Dip I	630	XT5L 630 Ekip M Dip I In=630A		

SACE XT5L (120 kA) Ekip M Dip LIU - Front terminals (F)

Size	lu	Trip units	In	Type	3 poles	4 poles
					Code	Code
XT5	400	Ekip M Dip LIU	250	XT5L 400 Ekip M Dip LIU In=250A	Only available with the Breaking Part + Trip unit solution	
			320	XT5L 400 Ekip M Dip LIU In=320A		
			400	XT5L 400 Ekip M Dip LIU In=400A		
XT5	630	Ekip M Dip LIU	500	XT5L 630 Ekip M Dip LIU In=500A		

Generator protection circuit-breakers



—
XT5 - circuit-breaker

SACE XT5L (120 kA) TMG - Front terminals (F)

Size	lu	Trip units	In	Type	3 poles	4 poles
					Code	Code
XT5	400	TMG	320	XT5L 400 TMG 320-1600	Only available with the Breaking Part + Trip unit solution	
			400	XT5L 400 TMG 400-2000		
XT5	630	TMG	500	XT5L 630 TMG 500-2500		
			630	XT5L 630 TMG 630-3150		

Ordering codes for XT5

Automatic circuit-breakers

Distribution circuit-breakers

SACE XT5V (150 kA) TMA - Front terminals (F)



XT5 - circuit-breaker

Size	lu	Trip units	In	Type	3 poles	4 poles
					Code	Code
XT5	400	TMA	320	XT5V 400 TMA 320-3200	Only available with the Breaking Part + Trip unit solution	
			400	XT5V 400 TMA 400-4000		
			320	XT5V 400 TMA 320-3200 InN=50%		
			400	XT5V 400 TMA 400-4000 InN=50%		
XT5	630	TMA	500	XT5V 630 TMA 500-5000		
			630	XT5V 630 TMA 630-6300		
			500	XT5V 630 TMA 500-5000 InN=50%		
			630	XT5V 630 TMA 630-6300 InN=50%		

SACE XT5V (150 kA) Ekip Dip LS/I - Front terminals (F)

Size	lu	Trip units	In	Type	3 poles	4 poles
					Code	Code
XT5	400	Ekip Dip LS/I	250	XT5V 400 Ekip Dip LS/I In=250	Only available with the Breaking Part + Trip unit solution	
			320	XT5V 400 Ekip Dip LS/I In=320		
			400	XT5V 400 Ekip Dip LS/I In=400		
XT5	630	Ekip Dip LS/I	630	XT5V 630 Ekip Dip LS/I In=630		

SACE XT5V (150 kA) Ekip Dip LSI - Front terminals (F)

Size	lu	Trip units	In	Type	3 poles	4 poles
					Code	Code
XT5	400	Ekip Dip LSI	250	XT5V 400 Ekip Dip LSI In=250	Only available with the Breaking Part + Trip unit solution	
			320	XT5V 400 Ekip Dip LSI In=320		
			400	XT5V 400 Ekip Dip LSI In=400		
XT5	630	Ekip Dip LSI	630	XT5V 630 Ekip Dip LSI In=630		

SACE XT5V (150 kA) Ekip Dip LSIG - Front terminals (F)

Size	lu	Trip units	In	Type	3 poles	4 poles
					Code	Code
XT5	400	Ekip Dip LSIG	250	XT5V 400 Ekip Dip LSIG In=250	Only available with the Breaking Part + Trip unit solution	
			320	XT5V 400 Ekip Dip LSIG In=320		
			400	XT5V 400 Ekip Dip LSIG In=400		
XT5	630	Ekip Dip LSIG	630	XT5V 630 Ekip Dip LSIG In=630		

SACE XT5V (150 kA) Ekip Dip LIG - Front terminals (F)

Size	lu	Trip units	In	Type	3 poles	4 poles
					Code	Code
XT5	400	Ekip Dip LIG	250	XT5V 400 Ekip Dip LIG In=250	Only available with the Breaking Part + Trip unit solution	
			320	XT5V 400 Ekip Dip LIG In=320		
			400	XT5V 400 Ekip Dip LIG In=400		
XT5	630	Ekip Dip LIG	630	XT5V 630 Ekip Dip LIG In=630		

Motor protection circuit-breakers

SACE XT5V (150 kA) MA - Front terminals (F)

Size	lu	Trip units	In	Type	3 poles	4 poles
					Code	Code
XT5 400	MA		320	XT5V 400 MA 320-3200	Only available with the Breaking Part + Trip unit solution	
			400	XT5V 400 MA 400-4000		
XT5 630	MA	500	XT5V 630 MA 500-5000			

SACE XT5V (150 kA) Ekip M Dip I - Front terminals (F)

Size	lu	Trip units	In	Type	3 poles	4 poles
					Code	Code
XT5 400	Ekip M Dip I		320	XT5V 400 Ekip M Dip I In=320A	Only available with the Breaking Part + Trip unit solution	
			400	XT5V 400 Ekip M Dip I In=400A		
XT5 630	Ekip M Dip I	630	XT5V 630 Ekip M Dip I In=630A			

SACE XT5V (150 kA) Ekip M Dip LIU - Front terminals (F)

Size	lu	Trip units	In	Type	3 poles	4 poles
					Code	Code
XT5 400	Ekip M Dip LIU		250	XT5V 400 Ekip M Dip LIU In=250A	Only available with the Breaking Part + Trip unit solution	
			320	XT5V 400 Ekip M Dip LIU In=320A		
			400	XT5V 400 Ekip M Dip LIU In=400A		
XT5 630	Ekip M Dip LIU	500	XT5V 630 Ekip M Dip LIU In=500A			

Generator protection circuit-breakers

SACE XT5V (150 kA) TMG - Front terminals (F)

Size	lu	Trip units	In	Type	3 poles	4 poles		
					Code	Code		
XT5 400	TMG		320	XT5V 400 TMG 320-1600	Only available with the Breaking Part + Trip unit solution			
			400	XT5V 400 TMG 400-2000				
XT5 630	TMG		500	XT5V 630 TMG 500-2500				
			630	XT5V 630 TMG 630-3150				



XT5 - circuit-breaker



XT5 - circuit-breaker

Ordering codes for XT5

Automatic circuit-breakers

Distribution circuit-breakers

SACE XT5X (200 kA) TMA - Front terminals (F)



XT5 - circuit-breaker

Size	lu	Trip units	In	Type	3 poles	4 poles
					Code	Code
XT5	400	TMA	320	XT5X 400 TMA 320-3200	Only available with the Breaking Part + Trip unit solution	
			400	XT5X 400 TMA 400-4000		
			320	XT5X 400 TMA 320-3200 InN=50%		
			400	XT5X 400 TMA 400-4000 InN=50%		
XT5	630	TMA	500	XT5X 630 TMA 500-5000		
			630	XT5X 630 TMA 630-6300		
			500	XT5X 630 TMA 500-5000 InN=50%		
			630	XT5X 630 TMA 630-6300 InN=50%		

SACE XT5X (200 kA) Ekip Dip LS/I - Front terminals (F)

Size	lu	Trip units	In	Type	3 poles	4 poles
					Code	Code
XT5	400	Ekip Dip LS/I	250	XT5X 400 Ekip Dip LS/I In=250	Only available with the Breaking Part + Trip unit solution	
			320	XT5X 400 Ekip Dip LS/I In=320		
			400	XT5X 400 Ekip Dip LS/I In=400		
XT5	630	Ekip Dip LS/I	630	XT5X 630 Ekip Dip LS/I In=630		

SACE XT5X (200 kA) Ekip Dip LSI - Front terminals (F)

Size	lu	Trip units	In	Type	3 poles	4 poles
					Code	Code
XT5	400	Ekip Dip LSI	250	XT5X 400 Ekip Dip LSI In=250	Only available with the Breaking Part + Trip unit solution	
			320	XT5X 400 Ekip Dip LSI In=320		
			400	XT5X 400 Ekip Dip LSI In=400		
XT5	630	Ekip Dip LSI	630	XT5X 630 Ekip Dip LSI In=630		

SACE XT5X (200 kA) Ekip Dip LSIG - Front terminals (F)

Size	lu	Trip units	In	Type	3 poles	4 poles
					Code	Code
XT5	400	Ekip Dip LSIG	250	XT5X 400 Ekip Dip LSIG In=250	Only available with the Breaking Part + Trip unit solution	
			320	XT5X 400 Ekip Dip LSIG In=320		
			400	XT5X 400 Ekip Dip LSIG In=400		
XT5	630	Ekip Dip LSIG	630	XT5X 630 Ekip Dip LSIG In=630		

SACE XT5X (200 kA) Ekip Dip LIG - Front terminals (F)

Size	lu	Trip units	In	Type	3 poles	4 poles
					Code	Code
XT5	400	Ekip Dip LIG	250	XT5X 400 Ekip Dip LIG In=250	Only available with the Breaking Part + Trip unit solution	
			320	XT5X 400 Ekip Dip LIG In=320		
			400	XT5X 400 Ekip Dip LIG In=400		
XT5	630	Ekip Dip LIG	630	XT5X 630 Ekip Dip LIG In=630		

Motor protection circuit-breakers

SACE XT5X (200 kA) MA - Front terminals (F)

Size	lu	Trip units	In	Type	3 poles	4 poles
					Code	Code
XT5 400	MA		320	XT5X 400 MA 320-3200	Only available with the Breaking Part + Trip unit solution	
			400	XT5X 400 MA 400-4000		
XT5 630	MA	500	XT5X 630 MA 500-5000			

SACE XT5X (200 kA) Ekip M Dip I - Front terminals (F)

Size	lu	Trip units	In	Type	3 poles	4 poles
					Code	Code
XT5 400	Ekip M Dip I		320	XT5X 400 Ekip M Dip I In=320A	Only available with the Breaking Part + Trip unit solution	
			400	XT5X 400 Ekip M Dip I In=400A		
XT5 630	Ekip M Dip I	630	XT5X 630 Ekip M Dip I In=630A			

SACE XT5X (200 kA) Ekip M Dip LIU - Front terminals (F)

Size	lu	Trip units	In	Type	3 poles	4 poles
					Code	Code
XT5 400	Ekip M Dip LIU		250	XT5X 400 Ekip M Dip LIU In=250A	Only available with the Breaking Part + Trip unit solution	
			320	XT5X 400 Ekip M Dip LIU In=320A		
			400	XT5X 400 Ekip M Dip LIU In=400A		
XT5 630	Ekip M Dip LIU	500	XT5X 630 Ekip M Dip LIU In=500A			

Generator protection circuit-breakers

SACE XT5X (200 kA) TMG - Front terminals (F)

Size	lu	Trip units	In	Type	3 poles	4 poles
					Code	Code
XT5 400	TMG		320	XT5X 400 TMG 320-1600	Only available with the Breaking Part + Trip unit solution	
			400	XT5X 400 TMG 400-2000		
XT5 630	TMG		500	XT5X 630 TMG 500-2500		
			630	XT5X 630 TMG 630-3150		



—
XT5 - circuit-breaker



—
XT5 - circuit-breaker

Ordering codes for XT5

Switch-disconnectors



XT5D -
switch-disconnector

SACE XT5D - Switch-disconnectors

Size	Iu	Type	3 poles	4 poles
			Code	Code
XT5	400	XT5D 400	1SDA100546R1	1SDA100548R1
	630	XT5D 630	1SDA100547R1	1SDA100549R1

Ordering codes for XT5

Breaking part



XT5 - breaking part

SACE XT5 - Breaking part

Size	Iu	Icu (415 V)	Type	3 poles	4 poles
				Code	Code
XT5	400	36	XT5N 400 Breaking part	1SDA100550R1	1SDA100552R1
	630	36	XT5N 630 Breaking part	1SDA100551R1	1SDA100553R1
	400	50	XT5S 400 Breaking part	1SDA100554R1	1SDA100556R1
	630	50	XT5S 630 Breaking part	1SDA100555R1	1SDA100557R1
	400	70	XT5H 400 Breaking part	1SDA100558R1	1SDA100560R1
	630	70	XT5H 630 Breaking part	1SDA100559R1	1SDA100561R1
	400	120	XT5L 400 Breaking part	1SDA100562R1	1SDA100564R1
	630	120	XT5L 630 Breaking part	1SDA100563R1	1SDA100565R1
	400	150	XT5V 400 Breaking part	1SDA100566R1	1SDA100568R1
	630	150	XT5V 630 Breaking part	1SDA100567R1	1SDA100569R1
	400	200	XT5X 400 Breaking part	1SDA100571R1	1SDA100573R1
	630	200	XT5X 630 Breaking part	1SDA100570R1	1SDA100572R1

Ordering codes for XT5

Trip units

Trip units - Distribution protection

Size	Type	3 poles	4 poles
		Code	Code
XT5	TMA 320-3200	1SDA100574R1	1SDA100655R1
	TMA 400-4000	1SDA100575R1	1SDA100656R1
	TMA 500-5000	1SDA100576R1	1SDA100657R1
	TMA 630-6300	1SDA100577R1	1SDA100658R1
	TMA 320-3200 InN=50%		1SDA100651R1
	TMA 400-4000 InN=50%		1SDA100652R1
	TMA 500-5000 InN=50%		1SDA100653R1
	TMA 630-6300 InN=50%		1SDA100654R1
	Ekip Dip LS/I In=250	1SDA100578R1	1SDA100659R1
	Ekip Dip LS/I In=320	1SDA100579R1	1SDA100660R1
	Ekip Dip LS/I In=400	1SDA100580R1	1SDA100661R1
	Ekip Dip LS/I In=630	1SDA100581R1	1SDA100662R1
	Ekip Dip LSI In=250	1SDA100582R1	1SDA100663R1
	Ekip Dip LSI In=320	1SDA100583R1	1SDA100664R1
	Ekip Dip LSI In=400	1SDA100584R1	1SDA100665R1
	Ekip Dip LSI In=630	1SDA100585R1	1SDA100666R1
	Ekip Dip LSIG In=250	1SDA100586R1	1SDA100667R1
	Ekip Dip LSIG In=320	1SDA100587R1	1SDA100668R1
	Ekip Dip LSIG In=400	1SDA100588R1	1SDA100669R1
	Ekip Dip LSIG In=630	1SDA100589R1	1SDA100670R1
	Ekip Dip LIG In=250	1SDA100647R1	1SDA100714R1
	Ekip Dip LIG In=320	1SDA100648R1	1SDA100715R1
	Ekip Dip LIG In=400	1SDA100649R1	1SDA100716R1
	Ekip Dip LIG In=630	1SDA100650R1	1SDA100717R1
	Ekip Touch LSI In=250	1SDA100590R1	1SDA100671R1
	Ekip Touch LSI In=320	1SDA100591R1	1SDA100672R1
	Ekip Touch LSI In=400	1SDA100592R1	1SDA100673R1
	Ekip Touch LSI In=630	1SDA100593R1	1SDA100674R1
	Ekip Touch LSIG In=250	1SDA100594R1	1SDA100675R1
	Ekip Touch LSIG In=320	1SDA100595R1	1SDA100676R1
	Ekip Touch LSIG In=400	1SDA100596R1	1SDA100677R1
	Ekip Touch LSIG In=630	1SDA100597R1	1SDA100678R1
	Ekip Touch Measuring LSI In=250	1SDA100598R1	1SDA100679R1
	Ekip Touch Measuring LSI In=320	1SDA100599R1	1SDA100680R1
	Ekip Touch Measuring LSI In=400	1SDA100600R1	1SDA100681R1
	Ekip Touch Measuring LSI In=630	1SDA100601R1	1SDA100682R1
	Ekip Touch Measuring LSIG In=250	1SDA100602R1	1SDA100683R1
	Ekip Touch Measuring LSIG In=320	1SDA100603R1	1SDA100684R1
	Ekip Touch Measuring LSIG In=400	1SDA100604R1	1SDA100685R1
	Ekip Touch Measuring LSIG In=630	1SDA100605R1	1SDA100686R1
Ekip Hi-Touch LSI In=250	1SDA100606R1	1SDA100687R1	
Ekip Hi-Touch LSI In=320	1SDA100607R1	1SDA100688R1	
Ekip Hi-Touch LSI In=400	1SDA100608R1	1SDA100689R1	
Ekip Hi-Touch LSI In=630	1SDA100609R1	1SDA100690R1	
Ekip Hi-Touch LSIG In=250	1SDA100610R1	1SDA100691R1	
Ekip Hi-Touch LSIG In=320	1SDA100611R1	1SDA100692R1	
Ekip Hi-Touch LSIG In=400	1SDA100612R1	1SDA100693R1	
Ekip Hi-Touch LSIG In=630	1SDA100613R1	1SDA100694R1	



Thermal magnetic trip unit



Dip trip unit



Touch trip unit

Trip units - Motor protection

Size	Type	3 poles	4 poles
		Code	Code
XT5	MA 320 Im=2240...4160	1SDA100614R1	
	MA 400 Im=2800...5200	1SDA100615R1	
	MA 500 Im=3500...6500	1SDA100616R1	
	Ekip M Dip I In=320	1SDA100617R1	
	Ekip M Dip I In=400	1SDA100618R1	
	Ekip M Dip I In=630	1SDA100619R1	
	Ekip M Dip LIU In=250	1SDA100620R1	
	Ekip M Dip LIU In=320	1SDA100621R1	
	Ekip M Dip LIU In=400	1SDA100622R1	
	Ekip M Dip LIU In=500	1SDA100623R1	
	Ekip M Touch LRIU In=250	1SDA100624R1	
	Ekip M Touch LRIU In=320	1SDA100625R1	
	Ekip M Touch LRIU In=400	1SDA100626R1	
	Ekip M Touch LRIU In=500	1SDA100627R1	

Trip units - Generator protection

Size	Type	3 poles	4 poles
		Code	Code
XT5	TMG 320-1600	1SDA100628R1	1SDA100695R1
	TMG 400-2000	1SDA100629R1	1SDA100696R1
	TMG 500-2500	1SDA100630R1	1SDA100697R1
	TMG 630-3150	1SDA100631R1	1SDA100698R1
	Ekip G Dip LS/I In=250 3p XT5	1SDA100632R1	1SDA100699R1
	Ekip G Dip LS/I In=320 3p XT5	1SDA100633R1	1SDA100700R1
	Ekip G Dip LS/I In=400 3p XT5	1SDA100634R1	1SDA100701R1
	Ekip G Dip LS/I In=630 3p XT5	1SDA100635R1	1SDA100702R1
	Ekip G Touch LSIG In=250	1SDA100636R1	1SDA100703R1
	Ekip G Touch LSIG In=320	1SDA100637R1	1SDA100704R1
	Ekip G Touch LSIG In=400	1SDA100638R1	1SDA100705R1
	Ekip G Touch LSIG In=630	1SDA100639R1	1SDA100706R1
	Ekip G Hi-Touch LSIG In=250	1SDA100640R1	1SDA100707R1
	Ekip G Hi-Touch LSIG In=320	1SDA100641R1	1SDA100708R1
	Ekip G Hi-Touch LSIG In=400	1SDA100642R1	1SDA100709R1
	Ekip G Hi-Touch LSIG In=630	1SDA100643R1	1SDA100710R1

Ordering codes for XT5

Breaking part + trip unit solution



XT5 Breaking part



Thermal-Magnetic trip unit



Ekip Dip Trip Unit



Ekip Touch trip unit

Breaking Part	Icu		N (36 kA)	S (50 kA)	H (70 kA)	L (120 kA)	V (150 kA)	X (200 kA)
	Poles	Iu						
	3	400	100550	100554	100558	100562	100566	100570
	3	630	100551	100555	100559	100563	100567	100571
	4	400	100552	100556	100560	100564	100568	100572
	4	630	100553	100557	100561	100565	100569	100573

Trip units	In		250	320	400	500	630
	Poles						
TMA	3		100574	100575	100576	100577	
	4		100655*	100656*	100657*	100658*	
Ekip Dip LS/I	3		100578	100579	100580		100581
	4		100659	100660	100661		100662
Ekip Dip LSI	3		100582	100583	100584		100585
	4		100663	100664	100665		100666
Ekip Dip LSIG	3		100586	100587	100588		100589
	4		100667	100668	100669		100670
Ekip Dip LIG	3		100647	100648	100649		100650
	4		100714	100715	100716		100717
Ekip Touch LSI	3		100590	100591	100592		100593
	4		100671	100672	100673		100674
Ekip Touch LSIG	3		100594	100595	100596		100597
	4		100675	100676	100677		100678
Ekip Touch Measuring LSI	3		100598	100599	100600		100601
	4		100679	100680	100681		100682
Ekip Touch Measuring LSIG	3		100602	100603	100604		100605
	4		100683	100684	100685		100686
Ekip Hi-Touch LSI	3		100606	100607	100608		100609
	4		100687	100688	100689		100690
Ekip Hi-Touch LSIG	3		100610	100611	100612		100613
	4		100691	100692	100693		100694
MA	3		100614	100615	100616		
Ekip M Dip I	3		100617	100618			100619
Ekip M Dip LIU	3		100620	100621	100622	100623	
Ekip M Touch LRIU	3		100624	100625	100626	100627	
TMG	3		100628	100629	100630		100631
	4		100695	100696	100697		100698
Ekip G Dip LS/I	3		100632	100633	100634		100635
	4		100699	100700	100701		100702
Ekip G Touch LSIG	3		100636	100637	100638		100639
	4		100703	100704	100705		100706
Ekip G Hi-Touch LSIG	3		100640	100641	100642		100643
	4		100707	100708	100709		100710

* InN= 100%. Combinations available for InN=50% too. For ordering codes, please see in reference pages 'trip Units'

Note: When a single code for the complete circuit-breaker is not available, please configure the breaking part code with the trip unit code to order a factory-assembled circuit-breaker

Ordering codes for XT6

Automatic circuit-breakers

Distribution circuit-breakers

SACE XT6N (36 kA) TMA - Front terminals (F)

Size	lu	Trip units	In	Type	3 poles	4 poles
					Code	Code
XT6	800	TMA	630	XT6N 800 TMA 630-6300	1SDA107561R1	1SDA107569R1
			630	XT6N 800 TMA 630-6300 InN=50%		1SDA107568R1
			800	XT6N 800 TMA 800-8000	1SDA100718R1	1SDA100731R1
			800	XT6N 800 TMA 800-8000 InN=50%		1SDA100730R1

SACE XT6N (36 kA) Ekip Dip LS/I - Front terminals (F)

Size	lu	Trip units	In	Type	3 poles	4 poles
					Code	Code
XT6	800	Ekip Dip LS/I	630	XT6N 800 Ekip Dip LS/I In=630	1SDA107562R1	1SDA107570R1
			800	XT6N 800 Ekip Dip LS/I In=800	1SDA100719R1	1SDA100732R1
XT6	1000	Ekip Dip LS/I	1000	XT6N 1000 Ekip Dip LS/I In=1000	1SDA100720R1	1SDA100733R1

SACE XT6N (36 kA) Ekip Dip LSI - Front terminals (F)

Size	lu	Trip units	In	Type	3 poles	4 poles
					Code	Code
XT6	800	Ekip Dip LSI	630	XT6N 800 Ekip Dip LSI In=630	1SDA107563R1	1SDA107571R1
			800	XT6N 800 Ekip Dip LSI In=800	1SDA100721R1	1SDA100734R1
XT6	1000	Ekip Dip LSI	1000	XT6N 1000 Ekip Dip LSI In=1000	1SDA100722R1	1SDA100735R1

SACE XT6N (36 kA) Ekip Dip LSIG - Front terminals (F)

Size	lu	Trip units	In	Type	3 poles	4 poles
					Code	Code
XT6	800	Ekip Dip LSIG	630	XT6N 800 Ekip Dip LSIG In=630	1SDA107564R1	1SDA107572R1
			800	XT6N 800 Ekip Dip LSIG In=800	1SDA100723R1	1SDA100736R1
XT6	1000	Ekip Dip LSIG	1000	XT6N 1000 Ekip Dip LSIG In=1000	1SDA100724R1	1SDA100737R1

SACE XT6N (36 kA) Ekip Dip LIG - Front terminals (F)

Size	lu	Trip units	In	Type	3 poles	4 poles
					Code	Code
XT6	800	Ekip Dip LIG	630	XT6N 800 Ekip Dip LIG In=630	1SDA107567R1	1SDA107573R1
			800	XT6N 800 Ekip Dip LIG In=800	1SDA100728R1	1SDA100738R1
XT6	1000	Ekip Dip LIG	1000	XT6N 1000 Ekip Dip LIG In=1000	1SDA100729R1	1SDA100739R1

Motor protection circuit-breakers

SACE XT6N (36 kA) Ekip M Dip I - Front terminals (F)

Size	lu	Trip units	In	Type	3 poles	4 poles
					Code	Code
XT6	800	Ekip M Dip I	630	XT6N 800 Ekip M Dip I In=630	1SDA107565R1	
			800	XT6N 800 Ekip M Dip I In=800A	1SDA100725R1	
XT6	1000	Ekip M Dip I	1000	XT6N 1000 Ekip M Dip I In=1000A	1SDA100726R1	

SACE XT6N (36 kA) Ekip M Dip LIU - Front terminals (F)

Size	lu	Trip units	In	Type	3 poles	4 poles
					Code	Code
XT6	800	Ekip M Dip LIU	630	XT6N 800 Ekip M Dip LIU In=630	1SDA107566R1	
			800	XT6N 800 Ekip M Dip LIU In=800A	1SDA100727R1	



XT6 - circuit-breaker



XT6 - circuit-breaker

Ordering codes for XT6

Automatic circuit-breakers

Distribution circuit-breakers

SACE XT6S (50 kA) TMA - Front terminals (F)

Size	lu	Trip units	In	Type	3 poles	4 poles
					Code	Code
XT6	800	TMA	630	XT6S 800 TMA 630-6300	1SDA107574R1	1SDA107582R1
			630	XT6S 800 TMA 630-6300 InN=50%		1SDA107581R1
			800	XT6S 800 TMA 800-8000	1SDA100740R1	1SDA100753R1
			800	XT6S 800 TMA 800-8000 InN=50%		1SDA100752R1

SACE XT6S (50 kA) Ekip Dip LS/I - Front terminals (F)

Size	lu	Trip units	In	Type	3 poles	4 poles
					Code	Code
XT6	800	Ekip Dip LS/I	630	XT6S 800 Ekip Dip LS/I In=630	1SDA107575R1	1SDA107583R1
			800	XT6S 800 Ekip Dip LS/I In=800	1SDA100741R1	1SDA100754R1
XT6	1000	Ekip Dip LS/I	1000	XT6S 1000 Ekip Dip LS/I In=1000	1SDA100742R1	1SDA100755R1

SACE XT6S (50 kA) Ekip Dip LSI - Front terminals (F)

Size	lu	Trip units	In	Type	3 poles	4 poles
					Code	Code
XT6	800	Ekip Dip LSI	630	XT6S 800 Ekip Dip LSI In=630	1SDA107576R1	1SDA107584R1
			800	XT6S 800 Ekip Dip LSI In=800	1SDA100743R1	1SDA100756R1
XT6	1000	Ekip Dip LSI	1000	XT6S 1000 Ekip Dip LSI In=1000	1SDA100744R1	1SDA100757R1

SACE XT6S (50 kA) Ekip Dip LSIG - Front terminals (F)

Size	lu	Trip units	In	Type	3 poles	4 poles
					Code	Code
XT6	800	Ekip Dip LSIG	630	XT6S 800 Ekip Dip LSIG In=630	1SDA107577R1	1SDA107585R1
			800	XT6S 800 Ekip Dip LSIG In=800	1SDA100745R1	1SDA100758R1
XT6	1000	Ekip Dip LSIG	1000	XT6S 1000 Ekip Dip LSIG In=1000	1SDA100746R1	1SDA100759R1

SACE XT6S (50 kA) Ekip Dip LIG - Front terminals (F)

Size	lu	Trip units	In	Type	3 poles	4 poles
					Code	Code
XT6	800	Ekip Dip LIG	630	XT6S 800 Ekip Dip LIG In=630	1SDA107580R1	1SDA107586R1
			800	XT6S 800 Ekip Dip LIG In=800	1SDA100750R1	1SDA100760R1
XT6	1000	Ekip Dip LIG	1000	XT6S 1000 Ekip Dip LIG In=1000	1SDA100751R1	1SDA100761R1

Motor protection circuit-breakers

SACE XT6S (50 kA) Ekip M Dip I - Front terminals (F)

Size	lu	Trip units	In	Type	3 poles	4 poles
					Code	Code
XT6	800	Ekip M Dip I	630	XT6S 800 Ekip M Dip I In=630	1SDA107578R1	
			800	XT6S 800 Ekip M Dip I In=800	1SDA100747R1	
XT6	1000	Ekip M Dip I	1000	XT6S 1000 Ekip M Dip I In=1000	1SDA100748R1	

SACE XT6S (50 kA) Ekip M Dip LIU - Front terminals (F)

Size	lu	Trip units	In	Type	3 poles	4 poles
					Code	Code
XT6	800	Ekip M Dip LIU	630	XT6S 800 Ekip M Dip LIU In=630	1SDA107579R1	
			800	XT6S 800 Ekip M Dip LIU In=800A	1SDA100749R1	



XT6 - circuit-breaker



XT6 - circuit-breaker

Distribution circuit-breakers

SACE XT6H (70 kA) TMA - Front terminals (F)

Size	lu	Trip units	In	Type	3 poles	4 poles
					Code	Code
XT6	800	TMA	630	XT6H 800 TMA 630-6300	1SDA107587R1	1SDA107595R1
			630	XT6H 800 TMA 630-6300 InN=50%		1SDA107594R1
			800	XT6H 800 TMA 800-8000	1SDA100762R1	1SDA100775R1
			800	XT6H 800 TMA 800-8000 InN=50%		1SDA100774R1

SACE XT6H (70 kA) Ekip Dip LS/I - Front terminals (F)

Size	lu	Trip units	In	Type	3 poles	4 poles
					Code	Code
XT6	800	Ekip Dip LS/I	630	XT6H 800 Ekip Dip LS/I In=630	1SDA107588R1	1SDA107596R1
			800	XT6H 800 Ekip Dip LS/I In=800	1SDA100763R1	1SDA100776R1
XT6	1000	Ekip Dip LS/I	1000	XT6H 1000 Ekip Dip LS/I In=1000	1SDA100764R1	1SDA100777R1

SACE XT6H (70 kA) Ekip Dip LSI - Front terminals (F)

Size	lu	Trip units	In	Type	3 poles	4 poles
					Code	Code
XT6	800	Ekip Dip LSI	630	XT6H 800 Ekip Dip LSI In=630	1SDA107589R1	1SDA107597R1
			800	XT6H 800 Ekip Dip LSI In=800	1SDA100765R1	1SDA100778R1
XT6	1000	Ekip Dip LSI	1000	XT6H 1000 Ekip Dip LSI In=1000	1SDA100766R1	1SDA100779R1

SACE XT6H (70 kA) Ekip Dip LSIG - Front terminals (F)

Size	lu	Trip units	In	Type	3 poles	4 poles
					Code	Code
XT6	800	Ekip Dip LSIG	630	XT6H 800 Ekip Dip LSIG In=630	1SDA107590R1	1SDA107598R1
			800	XT6H 800 Ekip Dip LSIG In=800	1SDA100767R1	1SDA100780R1
XT6	1000	Ekip Dip LSIG	1000	XT6H 1000 Ekip Dip LSIG In=1000	1SDA100768R1	1SDA100781R1

SACE XT6H (70 kA) Ekip Dip LIG - Front terminals (F)

Size	lu	Trip units	In	Type	3 poles	4 poles
					Code	Code
XT6	800	Ekip Dip LIG	630	XT6H 800 Ekip Dip LIG In=630	1SDA107593R1	1SDA107599R1
			800	XT6H 800 Ekip Dip LIG In=800	1SDA100772R1	1SDA100782R1
XT6	1000	Ekip Dip LIG	1000	XT6H 1000 Ekip Dip LIG In=1000	1SDA100773R1	1SDA100783R1

Motor protection circuit-breakers

SACE XT6H (70 kA) Ekip M Dip I - Front terminals (F)

Size	lu	Trip units	In	Type	3 poles	4 poles
					Code	Code
XT6	800	Ekip M Dip I	630	XT6H 800 Ekip M Dip I In=630	1SDA107591R1	
			800	XT6H 800 Ekip M Dip I In=800	1SDA100769R1	
XT6	1000	Ekip M Dip I	1000	XT6H 1000 Ekip M Dip I In=1000	1SDA100770R1	

SACE XT6H (70 kA) Ekip M Dip LIU - Front terminals (F)

Size	lu	Trip units	In	Type	3 poles	4 poles
					Code	Code
XT6	800	Ekip M Dip LIU	630	XT6H 800 Ekip M Dip LIU In=630	1SDA107592R1	
			800	XT6H 800 Ekip M Dip LIU In=800A	1SDA100771R1	



XT6 - circuit-breaker



XT6 - circuit-breaker

Ordering codes for XT6

Switch-disconnectors



—
XT6 -
switch-disconnector

SACE XT6D - Switch-disconnectors

Size	Iu	Type	3 poles	4 poles
			Code	Code
XT6	630	XT6D 630	1SDA107600R1	1SDA107601R1
	800	XT6D 800	1SDA100784R1	1SDA100786R1
	1000	XT6D 1000	1SDA100785R1	1SDA100787R1

Ordering codes for XT6

Breaking part



XT6 - breaking part

SACE XT6 - Breaking part

Size	Iu	Icu (415 V)	Type	3 poles	4 poles
				Code	Code
XT6	800	36	XT6N 800 Breaking part	1SDA100788R1	1SDA100790R1
	1000	36	XT6N 1000 Breaking part	1SDA100789R1	1SDA100791R1
	800	50	XT6S 800 Breaking part	1SDA100792R1	1SDA100794R1
	1000	50	XT6S 1000 Breaking part	1SDA100793R1	1SDA100795R1
	800	70	XT6H 800 Breaking part	1SDA100796R1	1SDA100798R1
	1000	70	XT6H 1000 Breaking part	1SDA100797R1	1SDA100799R1

Ordering codes for XT6

Trip units

Trip units - Distribution protection

Size	Type	3 poles	4 poles
		Code	Code
XT6	TMA 630-6300	1SDA107602R1	1SDA107611R1
	TMA 630-6300 InN=50%In		1SDA107610R1
	TMA 800-8000	1SDA100800R1	1SDA100815R1
	TMA 800-8000 InN=50%		1SDA100814R1
	Ekip Dip LS/I In=630	1SDA107603R1	1SDA107612R1
	Ekip Dip LS/I In=800	1SDA100801R1	1SDA100816R1
	Ekip Dip LS/I In=1000	1SDA100802R1	1SDA100817R1
	Ekip Dip LSI In=630	1SDA107604R1	1SDA107613R1
	Ekip Dip LSI In=800	1SDA100803R1	1SDA100818R1
	Ekip Dip LSI In=1000	1SDA100804R1	1SDA100819R1
	Ekip Dip LSIG In=630	1SDA107605R1	1SDA107614R1
	Ekip Dip LSIG In=800	1SDA100805R1	1SDA100820R1
	Ekip Dip LSIG In=1000	1SDA100806R1	1SDA100821R1
	Ekip Dip LIG In=630	1SDA107609R1	1SDA107616R1
	Ekip Dip LIG In=800	1SDA100812R1	1SDA100824R1
	Ekip Dip LIG In=1000	1SDA100813R1	1SDA100825R1



Thermal magnetic trip unit



Dip trip unit

Trip units - Motor protection

Size	Type	3 poles	4 poles
		Code	Code
XT6	Ekip M Dip I In=630	1SDA107606R1	
	Ekip M Dip I In=800	1SDA100807R1	
	Ekip M Dip I In=1000	1SDA100808R1	
	Ekip M Dip LIU In=630	1SDA107607R1	
	Ekip M Dip LIU In=800	1SDA100809R1	

Trip units - Generator protection

Size	Type	3 poles	4 poles
		Code	Code
XT6	Ekip G Dip LS/I In=630	1SDA107608R1	1SDA107615R1
	Ekip G Dip LS/I In=800	1SDA100810R1	1SDA100822R1
	Ekip G Dip LS/I In=1000	1SDA100811R1	1SDA100823R1

Ordering codes for XT6

Breaking part + trip unit solution



XT6 Breaking Part



XT6 Breaking Part



XT6 Breaking Part

Breaking Part	Icu		N (36 kA)	S (50 kA)	H (70 kA)
	Poles	Iu			
	3	800	100788	100792	100796
	3	1000	100789	100793	100797
	4	800	100790	100794	100798
	4	1000	100791	100795	100799

Trip units	In	630	800	1000
		Poles		
TMA	3	107602	100800	
	4	107611	100815*	
Ekip Dip LS/I	3	107603	100801	100802
	4	107612	100816	100817
Ekip Dip LSI	3	107604	100803	100804
	4	107613	100818	100819
Ekip Dip LSIG	3	107605	100805	100806
	4	107614	100820	100821
Ekip Dip LIG	3	107609	100812	100813
	4	107616	100824	100825
Ekip M Dip I	3	107606	100807	100808
Ekip M Dip LIU	3	107607	100809	
Ekip G Dip LS/I	3	107608	100810	100811
	4	107615	100822	100823

* InN=100%. Combinations available for InN=50% too. For ordering codes, please see in reference pages 'trip Units'

Note: When a single code for the complete circuit-breaker is not available, please configure the breaking part code with the trip unit code to order a factory-assembled circuit-breaker

Ordering codes for XT7/XT7 M

Automatic circuit-breakers – XT7

Distribution circuit-breakers



XT7 - circuit-breaker

SACE XT7S (50 kA) Ekip Dip LS/I - Front terminals (F)

Size	lu	Trip units	In	Type	3 poles	4 poles
					Code	Code
XT7	800	Ekip Dip LS/I	800	XT7S 800 Ekip Dip LS/I In=800A	1SDA100826R1	1SDA101114R1
	1000	Ekip Dip LS/I	1000	XT7S 1000 Ekip Dip LS/I In=1000A	1SDA100827R1	1SDA101115R1
	1250	Ekip Dip LS/I	1250	XT7S 1250 Ekip Dip LS/I In=1250A	1SDA100828R1	1SDA101116R1
	1600	Ekip Dip LS/I	1600	XT7S 1600 Ekip Dip LS/I In=1600A	1SDA100829R1	1SDA101117R1

SACE XT7S (50 kA) Ekip Dip LSI - Front terminals (F)

Size	lu	Trip units	In	Type	3 poles	4 poles
					Code	Code
XT7	800	Ekip Dip LSI	800	XT7S 800 Ekip Dip LSI In=800A	1SDA100830R1	1SDA101118R1
	1000	Ekip Dip LSI	1000	XT7S 1000 Ekip Dip LSI In=1000A	1SDA100831R1	1SDA101119R1
	1250	Ekip Dip LSI	1250	XT7S 1250 Ekip Dip LSI In=1250A	1SDA100832R1	1SDA101120R1
	1600	Ekip Dip LSI	1600	XT7S 1600 Ekip Dip LSI In=1600A	1SDA100833R1	1SDA101121R1

SACE XT7S (50 kA) Ekip Dip LSIG - Front terminals (F)

Size	lu	Trip units	In	Type	3 poles	4 poles
					Code	Code
XT7	800	Ekip Dip LSIG	800	XT7S 800 Ekip Dip LSIG In=800A	1SDA100834R1	1SDA101122R1
	1000	Ekip Dip LSIG	1000	XT7S 1000 Ekip Dip LSIG In=1000A	1SDA100835R1	1SDA101123R1
	1250	Ekip Dip LSIG	1250	XT7S 1250 Ekip Dip LSIG In=1250A	1SDA100836R1	1SDA101124R1
	1600	Ekip Dip LSIG	1600	XT7S 1600 Ekip Dip LSIG In=1600A	1SDA100837R1	1SDA101125R1

SACE XT7S (50 kA) Ekip Dip LIG - Front terminals (F)

Size	lu	Trip units	In	Type	3 poles	4 poles
					Code	Code
XT7	800	Ekip Dip LIG	800	XT7S 800 Ekip Dip LIG In=800A	1SDA100886R1	1SDA101166R1
	1000	Ekip Dip LIG	1000	XT7S 1000 Ekip Dip LIG In=1000A	1SDA100887R1	1SDA101167R1
	1250	Ekip Dip LIG	1250	XT7S 1250 Ekip Dip LIG In=1250A	1SDA100888R1	1SDA101168R1
	1600	Ekip Dip LIG	1600	XT7S 1600 Ekip Dip LIG In=1600A	1SDA100889R1	1SDA101169R1

SACE XT7S (50 kA) Ekip Touch LSI - Front terminals (F)

Size	lu	Trip units	In	Type	3 poles	4 poles
					Code	Code
XT7	800	Ekip Touch LSI	800	XT7S 800 Ekip Touch LSI In=800A	1SDA100838R1	1SDA101126R1
	1000	Ekip Touch LSI	1000	XT7S 1000 Ekip Touch LSI In=1000A	1SDA100839R1	1SDA101127R1
	1250	Ekip Touch LSI	1250	XT7S 1250 Ekip Touch LSI In=1250A	1SDA100840R1	1SDA101128R1
	1600	Ekip Touch LSI	1600	XT7S 1600 Ekip Touch LSI In=1600A	1SDA100841R1	1SDA101129R1



XT7 - circuit-breaker

SACE XT7S (50 kA) Ekip Touch LSI - Front terminals (F)

Size	lu	Trip units	In	Type	3 poles	4 poles
					Code	Code
XT7	800	Ekip Touch LSI	800	XT7S 800 Ekip Touch LSI In=800A	1SDA100842R1	1SDA101130R1
	1000	Ekip Touch LSI	1000	XT7S 1000 Ekip Touch LSI In1000A	1SDA100843R1	1SDA101131R1
	1250	Ekip Touch LSI	1250	XT7S 1250 Ekip Touch LSI In1250A	1SDA100844R1	1SDA101132R1
	1600	Ekip Touch LSI	1600	XT7S 1600 Ekip Touch LSI In1600A	1SDA100845R1	1SDA101133R1

SACE XT7S (50 kA) Ekip Touch Measuring LSI - Front terminals (F)

Size	lu	Trip units	In	Type	3 poles	4 poles
					Code	Code
XT7	800	Ekip Touch Meas.LSI	800	XT7S 800 Ekip Touch Meas.LSI In800	1SDA100846R1	1SDA101134R1
	1000	Ekip Touch Meas.LSI	1000	XT7S 1000 Ekip Touch Meas.LSI 1000	1SDA100847R1	1SDA101135R1
	1250	Ekip Touch Meas.LSI	1250	XT7S 1250 Ekip Touch Meas.LSI 1250	1SDA100848R1	1SDA101136R1
	1600	Ekip Touch Meas.LSI	1600	XT7S 1600 Ekip Touch Meas.LSI 1600	1SDA100849R1	1SDA101137R1

SACE XT7S (50 kA) Ekip Touch Measuring LSI - Front terminals (F)

Size	lu	Trip units	In	Type	3 poles	4 poles
					Code	Code
XT7	800	Ekip Touch Meas.LSIG	800	XT7S 800 Ekip Touch Meas.LSIG In800	1SDA100850R1	1SDA101138R1
	1000	Ekip Touch Meas.LSIG	1000	XT7S 1000 Ekip Touch Meas.LSIG 1000	1SDA100851R1	1SDA101139R1
	1250	Ekip Touch Meas.LSIG	1250	XT7S 1250 Ekip Touch Meas.LSIG 1250	1SDA100852R1	1SDA101140R1
	1600	Ekip Touch Meas.LSIG	1600	XT7S 1600 Ekip Touch Meas.LSIG 1600	1SDA100853R1	1SDA101141R1

SACE XT7S (50 kA) Ekip Hi-Touch LSI - Front terminals (F)

Size	lu	Trip units	In	Type	3 poles	4 poles
					Code	Code
XT7	800	Ekip Hi-Touch LSI	800	XT7S 800 Ekip Hi-Touch LSI In800A	1SDA100854R1	1SDA101142R1
	1000	Ekip Hi-Touch LSI	1000	XT7S 1000 Ekip Hi-Touch LSI 1000A	1SDA100855R1	1SDA101143R1
	1250	Ekip Hi-Touch LSI	1250	XT7S 1250 Ekip Hi-Touch LSI 1250A	1SDA100856R1	1SDA101144R1
	1600	Ekip Hi-Touch LSI	1600	XT7S 1600 Ekip Hi-Touch LSI 1600A	1SDA100857R1	1SDA101145R1

Ordering codes for XT7/XT7 M

Automatic circuit-breakers – XT7



XT7 - circuit-breaker

SACE XT7S (50 kA) Ekip Hi-Touch LSIG - Front terminals (F)

Size	lu	Trip units	In	Type	3 poles	4 poles
					Code	Code
XT7	800	Ekip Hi-Touch LSIG	800	XT7S 800 Ekip Hi-Touch LSIG In800A	1SDA100858R1	1SDA101146R1
	1000	Ekip Hi-Touch LSIG	1000	XT7S 1000 Ekip Hi-Touch LSIG 1000A	1SDA100859R1	1SDA101147R1
	1250	Ekip Hi-Touch LSIG	1250	XT7S 1250 Ekip Hi-Touch LSIG 1250A	1SDA100860R1	1SDA101148R1
	1600	Ekip Hi-Touch LSIG	1600	XT7S 1600 Ekip Hi-Touch LSIG 1600A	1SDA100861R1	1SDA101149R1

Motor protection circuit-breakers

SACE XT7S (50 kA) Ekip M Dip I - Front terminals (F)

Size	lu	Trip units	In	Type	3 poles	4 poles
					Code	Code
XT7	800	Ekip M Dip I	800	XT7S 800 Ekip M Dip I In=800A	1SDA100862R1	
	1000	Ekip M Dip I	1000	XT7S 1000 Ekip M Dip I In=1000A	1SDA100863R1	
	1250	Ekip M Dip I	1250	XT7S 1250 Ekip M Dip I In=1250A	1SDA100864R1	
	1600	Ekip M Dip I	1600	XT7S 1600 Ekip M Dip I In=1600A	1SDA100865R1	

SACE XT7S (50 kA) Ekip M Touch LRIU - Front terminals (F)

Size	lu	Trip units	In	Type	3 poles	4 poles
					Code	Code
XT7	800	Ekip M Touch LRIU	800	XT7S 800 Ekip M Touch LRIU In800A	1SDA100866R1	
	1000	Ekip M Touch LRIU	1000	XT7S 1000 Ekip M Touch LRIU In1000	1SDA100867R1	
	1250	Ekip M Touch LRIU	1250	XT7S 1250 Ekip M Touch LRIU In1250	1SDA100868R1	
	1600	Ekip M Touch LRIU	1600	XT7S 1600 Ekip M Touch LRIU In1600	1SDA100869R1	

Generator protection circuit-breakers

SACE XT7S (50 kA) Ekip G Dip LS/I - Front terminals (F)



XT7 - circuit-breaker

Size	lu	Trip units	In	Type	3 poles	4 poles
					Code	Code
XT7	800	Ekip G Dip LS/I	800	XT7S 800 Ekip G Dip LS/I In=800A	1SDA100870R1	1SDA101150R1
	1000	Ekip G Dip LS/I	1000	XT7S 1000 Ekip G Dip LS/I In1000A	1SDA100871R1	1SDA101151R1
	1250	Ekip G Dip LS/I	1250	XT7S 1250 Ekip G Dip LS/I In1250A	1SDA100872R1	1SDA101152R1
	1600	Ekip G Dip LS/I	1600	XT7S 1600 Ekip G Dip LS/I In1600A	1SDA100873R1	1SDA101153R1

SACE XT7S (50 kA) Ekip G Touch LSIG- Front terminals (F)

Size	lu	Trip units	In	Type	3 poles	4 poles
					Code	Code
XT7	800	Ekip G Touch LSIG	800	XT7S 800 Ekip G Touch LSIG In800A	1SDA100874R1	1SDA101154R1
	1000	Ekip G Touch LSIG	1000	XT7S 1000 Ekip G Touch LSIG In1000	1SDA100875R1	1SDA101155R1
	1250	Ekip G Touch LSIG	1250	XT7S 1250 Ekip G Touch LSIG In1250	1SDA100876R1	1SDA101156R1
	1600	Ekip G Touch LSIG	1600	XT7S 1600 Ekip G Touch LSIG In1600	1SDA100877R1	1SDA101157R1

SACE XT7S (50 kA) Ekip G Hi-Touch LSIG - Front terminals (F)

Size	lu	Trip units	In	Type	3 poles	4 poles
					Code	Code
XT7	800	Ekip G Hi-Touch LSIG	800	XT7S 800 Ekip G Hi-Touch LSIG 800A	1SDA100878R1	1SDA101158R1
	1000	Ekip G Hi-Touch LSIG	1000	XT7S 1000 Ekip G Hi-TouchLSIG 1000	1SDA100879R1	1SDA101159R1
	1250	Ekip G Hi-Touch LSIG	1250	XT7S 1250 Ekip G Hi-TouchLSIG 1250	1SDA100880R1	1SDA101160R1
	1600	Ekip G Hi-Touch LSIG	1600	XT7S 1600 Ekip G Hi-TouchLSIG 1600	1SDA100881R1	1SDA101161R1

Ordering codes for XT7/XT7 M

Automatic circuit-breakers – XT7

Distribution circuit-breakers



XT7 - circuit-breaker

SACE XT7H (70 kA) Ekip Dip LS/I - Front terminals (F)

Size	lu	Trip units	In	Type	3 poles	4 poles
					Code	Code
XT7	800	Ekip Dip LS/I	800	XT7H 800 Ekip Dip LS/I In=800A	1SDA100890R1	1SDA101170R1
	1000	Ekip Dip LS/I	1000	XT7H 1000 Ekip Dip LS/I In=1000A	1SDA100891R1	1SDA101171R1
	1250	Ekip Dip LS/I	1250	XT7H 1250 Ekip Dip LS/I In=1250A	1SDA100892R1	1SDA101172R1
	1600	Ekip Dip LS/I	1600	XT7H 1600 Ekip Dip LS/I In=1600A	1SDA100893R1	1SDA101173R1

SACE XT7H (70 kA) Ekip Dip LSI - Front terminals (F)

Size	lu	Trip units	In	Type	3 poles	4 poles
					Code	Code
XT7	800	Ekip Dip LSI	800	XT7H 800 Ekip Dip LSI In=800A	1SDA100894R1	1SDA101174R1
	1000	Ekip Dip LSI	1000	XT7H 1000 Ekip Dip LSI In=1000A	1SDA100895R1	1SDA101175R1
	1250	Ekip Dip LSI	1250	XT7H 1250 Ekip Dip LSI In=1250A	1SDA100896R1	1SDA101176R1
	1600	Ekip Dip LSI	1600	XT7H 1600 Ekip Dip LSI In=1600A	1SDA100897R1	1SDA101177R1

SACE XT7H (70 kA) Ekip Dip LSIG - Front terminals (F)

Size	lu	Trip units	In	Type	3 poles	4 poles
					Code	Code
XT7	800	Ekip Dip LSIG	800	XT7H 800 Ekip Dip LSIG In=800A	1SDA100898R1	1SDA101178R1
	1000	Ekip Dip LSIG	1000	XT7H 1000 Ekip Dip LSIG In=1000A	1SDA100899R1	1SDA101179R1
	1250	Ekip Dip LSIG	1250	XT7H 1250 Ekip Dip LSIG In=1250A	1SDA100900R1	1SDA101180R1
	1600	Ekip Dip LSIG	1600	XT7H 1600 Ekip Dip LSIG In=1600A	1SDA100901R1	1SDA101181R1

SACE XT7H (70 kA) Ekip Dip LIG - Front terminals (F)

Size	lu	Trip units	In	Type	3 poles	4 poles
					Code	Code
XT7	800	Ekip Dip LIG	800	XT7H 800 Ekip Dip LIG In=800A	1SDA100950R1	1SDA101222R1
	1000	Ekip Dip LIG	1000	XT7H 1000 Ekip Dip LIG In=1000A	1SDA100951R1	1SDA101223R1
	1250	Ekip Dip LIG	1250	XT7H 1250 Ekip Dip LIG In=1250A	1SDA100952R1	1SDA101224R1
	1600	Ekip Dip LIG	1600	XT7H 1600 Ekip Dip LIG In=1600A	1SDA100953R1	1SDA101225R1

SACE XT7H (70 kA) Ekip Touch LSI - Front terminals (F)

Size	lu	Trip units	In	Type	3 poles	4 poles
					Code	Code
XT7	800	Ekip Touch LSI	800	XT7H 800 Ekip Touch LSI In=800A	1SDA100902R1	1SDA101182R1
	1000	Ekip Touch LSI	1000	XT7H 1000 Ekip Touch LSI In=1000A	1SDA100903R1	1SDA101183R1
	1250	Ekip Touch LSI	1250	XT7H 1250 Ekip Touch LSI In=1250A	1SDA100904R1	1SDA101184R1
	1600	Ekip Touch LSI	1600	XT7H 1600 Ekip Touch LSI In=1600A	1SDA100905R1	1SDA101185R1



XT7 - circuit-breaker

SACE XT7H (70 kA) Ekip Touch LSI - Front terminals (F)

Size	lu	Trip units	In	Type	3 poles	4 poles
					Code	Code
XT7	800	Ekip Touch LSI	800	XT7H 800 Ekip Touch LSI In=800A	1SDA100906R1	1SDA101186R1
	1000	Ekip Touch LSI	1000	XT7H 1000 Ekip Touch LSI In1000A	1SDA100907R1	1SDA101187R1
	1250	Ekip Touch LSI	1250	XT7H 1250 Ekip Touch LSI In1250A	1SDA100908R1	1SDA101188R1
	1600	Ekip Touch LSI	1600	XT7H 1600 Ekip Touch LSI In1600A	1SDA100909R1	1SDA101189R1

SACE XT7H (70 kA) Ekip Touch Measuring LSI - Front terminals (F)

Size	lu	Trip units	In	Type	3 poles	4 poles
					Code	Code
XT7	800	Ekip Touch Meas.LSI	800	XT7H 800 Ekip Touch Meas.LSI In800	1SDA100910R1	1SDA101190R1
	1000	Ekip Touch Meas.LSI	1000	XT7H 1000 Ekip Touch Meas.LSI 1000	1SDA100911R1	1SDA101191R1
	1250	Ekip Touch Meas.LSI	1250	XT7H 1250 Ekip Touch Meas.LSI 1250	1SDA100912R1	1SDA101192R1
	1600	Ekip Touch Meas.LSI	1600	XT7H 1600 Ekip Touch Meas.LSI 1600	1SDA100913R1	1SDA101193R1

SACE XT7H (70 kA) Ekip Touch Measuring LSI - Front terminals (F)

Size	lu	Trip units	In	Type	3 poles	4 poles
					Code	Code
XT7	800	Ekip Touch Meas.LSIG	800	XT7H 800 Ekip Touch Meas.LSIG In800	1SDA100914R1	1SDA101194R1
	1000	Ekip Touch Meas.LSIG	1000	XT7H 1000 Ekip Touch Meas.LSIG 1000	1SDA100915R1	1SDA101195R1
	1250	Ekip Touch Meas.LSIG	1250	XT7H 1250 Ekip Touch Meas.LSIG 1250	1SDA100916R1	1SDA101196R1
	1600	Ekip Touch Meas.LSIG	1600	XT7H 1600 Ekip Touch Meas.LSIG 1600	1SDA100917R1	1SDA101197R1

SACE XT7H (70 kA) Ekip Hi-Touch LSI - Front terminals (F)

Size	lu	Trip units	In	Type	3 poles	4 poles
					Code	Code
XT7	800	Ekip Hi-Touch LSI	800	XT7H 800 Ekip Hi-Touch LSI In800A	1SDA100918R1	1SDA101198R1
	1000	Ekip Hi-Touch LSI	1000	XT7H 1000 Ekip Hi-Touch LSI 1000A	1SDA100919R1	1SDA101199R1
	1250	Ekip Hi-Touch LSI	1250	XT7H 1250 Ekip Hi-Touch LSI 1250A	1SDA100920R1	1SDA101200R1
	1600	Ekip Hi-Touch LSI	1600	XT7H 1600 Ekip Hi-Touch LSI 1600A	1SDA100921R1	1SDA101201R1

Ordering codes for XT7/XT7 M

Automatic circuit-breakers – XT7



XT7 - circuit-breaker

SACE XT7H (70 kA) Ekip Hi-Touch LSIG - Front terminals (F)

Size	lu	Trip units	In	Type	3 poles	4 poles
					Code	Code
XT7	800	Ekip Hi-Touch LSIG	800	XT7H 800 Ekip Hi-Touch LSIG In800A	1SDA100922R1	1SDA101202R1
	1000	Ekip Hi-Touch LSIG	1000	XT7H 1000 Ekip Hi-Touch LSIG 1000A	1SDA100923R1	1SDA101203R1
	1250	Ekip Hi-Touch LSIG	1250	XT7H 1250 Ekip Hi-Touch LSIG 1250A	1SDA100924R1	1SDA101204R1
	1600	Ekip Hi-Touch LSIG	1600	XT7H 1600 Ekip Hi-Touch LSIG 1600A	1SDA100925R1	1SDA101205R1

Motor protection circuit-breakers

SACE XT7H (70 kA) Ekip M Dip I - Front terminals (F)

Size	lu	Trip units	In	Type	3 poles	4 poles
					Code	Code
XT7	800	Ekip M Dip I	800	XT7H 800 Ekip M Dip I In=800A	1SDA100926R1	
	1000	Ekip M Dip I	1000	XT7H 1000 Ekip M Dip I In=1000A	1SDA100927R1	
	1250	Ekip M Dip I	1250	XT7H 1250 Ekip M Dip I In=1250A	1SDA100928R1	
	1600	Ekip M Dip I	1600	XT7H 1600 Ekip M Dip I In=1600A	1SDA100929R1	



XT7 - circuit-breaker

SACE XT7H (70 kA) Ekip M Touch LRIU - Front terminals (F)

Size	lu	Trip units	In	Type	3 poles	4 poles
					Code	Code
XT7	800	Ekip M Touch LRIU	800	XT7H 800 Ekip M Touch LRIU In800A	1SDA100930R1	
	1000	Ekip M Touch LRIU	1000	XT7H 1000 Ekip M Touch LRIU In1000	1SDA100931R1	
	1250	Ekip M Touch LRIU	1250	XT7H 1250 Ekip M Touch LRIU In1250	1SDA100932R1	
	1600	Ekip M Touch LRIU	1600	XT7H 1600 Ekip M Touch LRIU In1600	1SDA100933R1	

Generator protection circuit-breakers



XT7 - circuit-breaker

SACE XT7H (70 kA) Ekip G Dip LS/I - Front terminals (F)

Size	Iu	Trip units	In	Type	3 poles	4 poles
					Code	Code
XT7	800	Ekip G Dip LS/I	800	XT7H 800 Ekip G Dip LS/I In=800A	1SDA100934R1	1SDA101206R1
	1000	Ekip G Dip LS/I	1000	XT7H 1000 Ekip G Dip LS/I In1000A	1SDA100935R1	1SDA101207R1
	1250	Ekip G Dip LS/I	1250	XT7H 1250 Ekip G Dip LS/I In1250A	1SDA100936R1	1SDA101208R1
	1600	Ekip G Dip LS/I	1600	XT7H 1600 Ekip G Dip LS/I In1600A	1SDA100937R1	1SDA101209R1

SACE XT7H (70 kA) Ekip G Touch LSIG- Front terminals (F)

Size	Iu	Trip units	In	Type	3 poles	4 poles
					Code	Code
XT7	800	Ekip G Touch LSIG	800	XT7H 800 Ekip G Touch LSIG In800A	1SDA100938R1	1SDA101210R1
	1000	Ekip G Touch LSIG	1000	XT7H 1000 Ekip G Touch LSIG In1000	1SDA100939R1	1SDA101211R1
	1250	Ekip G Touch LSIG	1250	XT7H 1250 Ekip G Touch LSIG In1250	1SDA100940R1	1SDA101212R1
	1600	Ekip G Touch LSIG	1600	XT7H 1600 Ekip G Touch LSIG In1600	1SDA100941R1	1SDA101213R1

SACE XT7H (70 kA) Ekip G Hi-Touch LSIG - Front terminals (F)

Size	Iu	Trip units	In	Type	3 poles	4 poles
					Code	Code
XT7	800	Ekip G Hi-Touch LSIG	800	XT7H 800 Ekip G Hi-Touch LSIG 800A	1SDA100942R1	1SDA101214R1
	1000	Ekip G Hi-Touch LSIG	1000	XT7H 1000 Ekip G Hi-TouchLSIG 1000	1SDA100943R1	1SDA101215R1
	1250	Ekip G Hi-Touch LSIG	1250	XT7H 1250 Ekip G Hi-TouchLSIG 1250	1SDA100944R1	1SDA101216R1
	1600	Ekip G Hi-Touch LSIG	1600	XT7H 1600 Ekip G Hi-TouchLSIG 1600	1SDA100945R1	1SDA101217R1

Ordering codes for XT7/XT7 M

Automatic circuit-breakers – XT7

Distribution circuit-breakers



XT7 - circuit-breaker

SACE XT7L (120 kA) Ekip Dip LS/I - Front terminals (F)

Size	lu	Trip units	In	Type	3 poles	4 poles
					Code	Code
XT7	800	Ekip Dip LS/I	800	XT7L 800 Ekip Dip LS/I In=800A	1SDA100954R1	1SDA101226R1
	1000	Ekip Dip LS/I	1000	XT7L 1000 Ekip Dip LS/I In=1000A	1SDA100955R1	1SDA101227R1
	1250	Ekip Dip LS/I	1250	XT7L 1250 Ekip Dip LS/I In=1250A	1SDA100956R1	1SDA101228R1
	1600	Ekip Dip LS/I	1600	XT7L 1600 Ekip Dip LS/I In=1600A	1SDA100957R1	1SDA101229R1

SACE XT7L (120 kA) Ekip Dip LSI - Front terminals (F)

Size	lu	Trip units	In	Type	3 poles	4 poles
					Code	Code
XT7	800	Ekip Dip LSI	800	XT7L 800 Ekip Dip LSI In=800A	1SDA100958R1	1SDA101230R1
	1000	Ekip Dip LSI	1000	XT7L 1000 Ekip Dip LSI In=1000A	1SDA100959R1	1SDA101231R1
	1250	Ekip Dip LSI	1250	XT7L 1250 Ekip Dip LSI In=1250A	1SDA100960R1	1SDA101232R1
	1600	Ekip Dip LSI	1600	XT7L 1600 Ekip Dip LSI In=1600A	1SDA100961R1	1SDA101233R1

SACE XT7L (120 kA) Ekip Dip LSIG - Front terminals (F)

Size	lu	Trip units	In	Type	3 poles	4 poles
					Code	Code
XT7	800	Ekip Dip LSIG	800	XT7L 800 Ekip Dip LSIG In=800A	1SDA100962R1	1SDA101234R1
	1000	Ekip Dip LSIG	1000	XT7L 1000 Ekip Dip LSIG In=1000A	1SDA100963R1	1SDA101235R1
	1250	Ekip Dip LSIG	1250	XT7L 1250 Ekip Dip LSIG In=1250A	1SDA100964R1	1SDA101236R1
	1600	Ekip Dip LSIG	1600	XT7L 1600 Ekip Dip LSIG In=1600A	1SDA100965R1	1SDA101237R1

SACE XT7L (120 kA) Ekip Dip LIG - Front terminals (F)

Size	lu	Trip units	In	Type	3 poles	4 poles
					Code	Code
XT7	800	Ekip Dip LIG	800	XT7L 800 Ekip Dip LIG In=800A	1SDA101014R1	1SDA101278R1
	1000	Ekip Dip LIG	1000	XT7L 1000 Ekip Dip LIG In=1000A	1SDA101015R1	1SDA101279R1
	1250	Ekip Dip LIG	1250	XT7L 1250 Ekip Dip LIG In=1250A	1SDA101016R1	1SDA101280R1
	1600	Ekip Dip LIG	1600	XT7L 1600 Ekip Dip LIG In=1600A	1SDA101017R1	1SDA101281R1

SACE XT7L (120 kA) Ekip Touch LSI - Front terminals (F)

Size	lu	Trip units	In	Type	3 poles	4 poles
					Code	Code
XT7	800	Ekip Touch LSI	800	XT7L 800 Ekip Touch LSI In=800A	1SDA100966R1	1SDA101238R1
	1000	Ekip Touch LSI	1000	XT7L 1000 Ekip Touch LSI In=1000A	1SDA100967R1	1SDA101239R1
	1250	Ekip Touch LSI	1250	XT7L 1250 Ekip Touch LSI In=1250A	1SDA100968R1	1SDA101240R1
	1600	Ekip Touch LSI	1600	XT7L 1600 Ekip Touch LSI In=1600A	1SDA100969R1	1SDA101241R1



XT7 - circuit-breaker

SACE XT7L (120 kA) Ekip Touch LSI - Front terminals (F)

Size	lu	Trip units	In	Type	3 poles	4 poles
					Code	Code
XT7	800	Ekip Touch LSI	800	XT7L 800 Ekip Touch LSI In=800A	1SDA100970R1	1SDA101242R1
	1000	Ekip Touch LSI	1000	XT7L 1000 Ekip Touch LSI In1000A	1SDA100971R1	1SDA101243R1
	1250	Ekip Touch LSI	1250	XT7L 1250 Ekip Touch LSI In1250A	1SDA100972R1	1SDA101244R1
	1600	Ekip Touch LSI	1600	XT7L 1600 Ekip Touch LSI In1600A	1SDA100973R1	1SDA101245R1

SACE XT7L (120 kA) Ekip Touch Measuring LSI - Front terminals (F)

Size	lu	Trip units	In	Type	3 poles	4 poles
					Code	Code
XT7	800	Ekip Touch Meas.LSI	800	XT7L 800 Ekip Touch Meas.LSI In800	1SDA100974R1	1SDA101246R1
	1000	Ekip Touch Meas.LSI	1000	XT7L 1000 Ekip Touch Meas.LSI 1000	1SDA100975R1	1SDA101247R1
	1250	Ekip Touch Meas.LSI	1250	XT7L 1250 Ekip Touch Meas.LSI 1250	1SDA100976R1	1SDA101248R1
	1600	Ekip Touch Meas.LSI	1600	XT7L 1600 Ekip Touch Meas.LSI 1600	1SDA100977R1	1SDA101249R1

SACE XT7L (120 kA) Ekip Touch Measuring LSI - Front terminals (F)

Size	lu	Trip units	In	Type	3 poles	4 poles
					Code	Code
XT7	800	Ekip Touch Meas.LSIG	800	XT7L 800 Ekip Touch Meas.LSIG In800	1SDA100978R1	1SDA101250R1
	1000	Ekip Touch Meas.LSIG	1000	XT7L 1000 Ekip Touch Meas.LSIG 1000	1SDA100979R1	1SDA101251R1
	1250	Ekip Touch Meas.LSIG	1250	XT7L 1250 Ekip Touch Meas.LSIG 1250	1SDA100980R1	1SDA101252R1
	1600	Ekip Touch Meas.LSIG	1600	XT7L 1600 Ekip Touch Meas.LSIG 1600	1SDA100981R1	1SDA101253R1

SACE XT7L (120 kA) Ekip Hi-Touch LSI - Front terminals (F)

Size	lu	Trip units	In	Type	3 poles	4 poles
					Code	Code
XT7	800	Ekip Hi-Touch LSI	800	XT7L 800 Ekip Hi-Touch LSI In800A	1SDA100982R1	1SDA101254R1
	1000	Ekip Hi-Touch LSI	1000	XT7L 1000 Ekip Hi-Touch LSI 1000A	1SDA100983R1	1SDA101255R1
	1250	Ekip Hi-Touch LSI	1250	XT7L 1250 Ekip Hi-Touch LSI 1250A	1SDA100984R1	1SDA101256R1
	1600	Ekip Hi-Touch LSI	1600	XT7L 1600 Ekip Hi-Touch LSI 1600A	1SDA100985R1	1SDA101257R1

Ordering codes for XT7/XT7 M

Automatic circuit-breakers – XT7



XT7 - circuit-breaker

SACE XT7L (120 kA) Ekip Hi-Touch LSIG - Front terminals (F)

Size	lu	Trip units	In	Type	3 poles	4 poles
					Code	Code
XT7	800	Ekip Hi-Touch LSIG	800	XT7L 800 Ekip Hi-Touch LSIG In800A	1SDA100986R1	1SDA101258R1
	1000	Ekip Hi-Touch LSIG	1000	XT7L 1000 Ekip Hi-Touch LSIG 1000A	1SDA100987R1	1SDA101259R1
	1250	Ekip Hi-Touch LSIG	1250	XT7L 1250 Ekip Hi-Touch LSIG 1250A	1SDA100988R1	1SDA101260R1
	1600	Ekip Hi-Touch LSIG	1600	XT7L 1600 Ekip Hi-Touch LSIG 1600A	1SDA100989R1	1SDA101261R1

Motor protection circuit-breakers

SACE XT7L (120 kA) Ekip M Dip I - Front terminals (F)

Size	lu	Trip units	In	Type	3 poles	4 poles
					Code	Code
XT7	800	Ekip M Dip I	800	XT7L 800 Ekip M Dip I In=800A	1SDA100990R1	
	1000	Ekip M Dip I	1000	XT7L 1000 Ekip M Dip I In=1000A	1SDA100991R1	
	1250	Ekip M Dip I	1250	XT7L 1250 Ekip M Dip I In=1250A	1SDA100992R1	
	1600	Ekip M Dip I	1600	XT7L 1600 Ekip M Dip I In=1600A	1SDA100993R1	

SACE XT7L (120 kA) Ekip M Touch LRIU - Front terminals (F)

Size	lu	Trip units	In	Type	3 poles	4 poles
					Code	Code
XT7	800	Ekip M Touch LRIU	800	XT7L 800 Ekip M Touch LRIU In800A	1SDA100994R1	
	1000	Ekip M Touch LRIU	1000	XT7L 1000 Ekip M Touch LRIU In1000	1SDA100995R1	
	1250	Ekip M Touch LRIU	1250	XT7L 1250 Ekip M Touch LRIU In1250	1SDA100996R1	
	1600	Ekip M Touch LRIU	1600	XT7L 1600 Ekip M Touch LRIU In1600	1SDA100997R1	



XT7 - circuit-breaker

Generator protection circuit-breakers



XT7 - circuit-breaker

SACE XT7L (120 kA) Ekip G Dip LS/I - Front terminals (F)

Size	lu	Trip units	In	Type	3 poles	4 poles
					Code	Code
XT7	800	Ekip G Dip LS/I	800	XT7L 800 Ekip G Dip LS/I In=800A	1SDA100998R1	1SDA101262R1
	1000	Ekip G Dip LS/I	1000	XT7L 1000 Ekip G Dip LS/I In1000A	1SDA100999R1	1SDA101263R1
	1250	Ekip G Dip LS/I	1250	XT7L 1250 Ekip G Dip LS/I In1250A	1SDA101000R1	1SDA101264R1
	1600	Ekip G Dip LS/I	1600	XT7L 1600 Ekip G Dip LS/I In1600A	1SDA101001R1	1SDA101265R1

SACE XT7L (120 kA) Ekip G Touch LSIG- Front terminals (F)

Size	lu	Trip units	In	Type	3 poles	4 poles
					Code	Code
XT7	800	Ekip G Touch LSIG	800	XT7L 800 Ekip G Touch LSIG In800A	1SDA101002R1	1SDA101266R1
	1000	Ekip G Touch LSIG	1000	XT7L 1000 Ekip G Touch LSIG In1000	1SDA101003R1	1SDA101267R1
	1250	Ekip G Touch LSIG	1250	XT7L 1250 Ekip G Touch LSIG In1250	1SDA101004R1	1SDA101268R1
	1600	Ekip G Touch LSIG	1600	XT7L 1600 Ekip G Touch LSIG In1600	1SDA101005R1	1SDA101269R1

SACE XT7L (120 kA) Ekip G Hi-Touch LSIG - Front terminals (F)

Size	lu	Trip units	In	Type	3 poles	4 poles
					Code	Code
XT7	800	Ekip G Hi-Touch LSIG	800	XT7L 800 Ekip G Hi-Touch LSIG 800A	1SDA101006R1	1SDA101270R1
	1000	Ekip G Hi-Touch LSIG	1000	XT7L 1000 Ekip G Hi-TouchLSIG 1000	1SDA101007R1	1SDA101271R1
	1250	Ekip G Hi-Touch LSIG	1250	XT7L 1250 Ekip G Hi-TouchLSIG 1250	1SDA101008R1	1SDA101272R1
	1600	Ekip G Hi-Touch LSIG	1600	XT7L 1600 Ekip G Hi-TouchLSIG 1600	1SDA101009R1	1SDA101273R1

Ordering codes for XT7/XT7 M

Automatic circuit-breakers – XT7 M

Distribution circuit-breakers

SACE XT7S M (50 kA) Ekip Dip LS/I - Front terminals (F)

Size	lu	Trip units	In	Type	3 poles	4 poles
					Code	Code
XT7	800	Ekip Dip LS/I	800	XT7S M 800 Ekip Dip LS/I In=800A	1SDA101366R1	1SDA101654R1
	1000	Ekip Dip LS/I	1000	XT7S M 1000 Ekip Dip LS/I In=1000A	1SDA101367R1	1SDA101655R1
	1250	Ekip Dip LS/I	1250	XT7S M 1250 Ekip Dip LS/I In=1250A	1SDA101368R1	1SDA101656R1
	1600	Ekip Dip LS/I	1600	XT7S M 1600 Ekip Dip LS/I In=1600A	1SDA101369R1	1SDA101657R1



XT7 M - circuit-breaker

SACE XT7S M (50 kA) Ekip Dip LSI - Front terminals (F)

Size	lu	Trip units	In	Type	3 poles	4 poles
					Code	Code
XT7	800	Ekip Dip LSI	800	XT7S M 800 Ekip Dip LSI In=800A	1SDA101370R1	1SDA101658R1
	1000	Ekip Dip LSI	1000	XT7S M 1000 Ekip Dip LSI In=1000A	1SDA101371R1	1SDA101659R1
	1250	Ekip Dip LSI	1250	XT7S M 1250 Ekip Dip LSI In=1250A	1SDA101372R1	1SDA101660R1
	1600	Ekip Dip LSI	1600	XT7S M 1600 Ekip Dip LSI In=1600A	1SDA101373R1	1SDA101661R1

SACE XT7S M (50 kA) Ekip Dip LSIG - Front terminals (F)

Size	lu	Trip units	In	Type	3 poles	4 poles
					Code	Code
XT7	800	Ekip Dip LSIG	800	XT7S M 800 Ekip Dip LSIG In=800A	1SDA101374R1	1SDA101662R1
	1000	Ekip Dip LSIG	1000	XT7S M 1000 Ekip Dip LSIG In=1000A	1SDA101375R1	1SDA101663R1
	1250	Ekip Dip LSIG	1250	XT7S M 1250 Ekip Dip LSIG In=1250A	1SDA101376R1	1SDA101664R1
	1600	Ekip Dip LSIG	1600	XT7S M 1600 Ekip Dip LSIG In=1600A	1SDA101377R1	1SDA101665R1

SACE XT7S M (50 kA) Ekip Dip LIG - Front terminals (F)

Size	lu	Trip units	In	Type	3 poles	4 poles
					Code	Code
XT7	800	Ekip Dip LIG	800	XT7S M 800 Ekip Dip LIG In=800A	1SDA101426R1	1SDA101706R1
	1000	Ekip Dip LIG	1000	XT7S M 1000 Ekip Dip LIG In=1000A	1SDA101427R1	1SDA101707R1
	1250	Ekip Dip LIG	1250	XT7S M 1250 Ekip Dip LIG In=1250A	1SDA101428R1	1SDA101708R1
	1600	Ekip Dip LIG	1600	XT7S M 1600 Ekip Dip LIG In=1600A	1SDA101429R1	1SDA101709R1

SACE XT7S M (50 kA) Ekip Touch LSI - Front terminals (F)

Size	lu	Trip units	In	Type	3 poles	4 poles
					Code	Code
XT7	800	Ekip Touch LSI	800	XT7S M 800 Ekip Touch LSI In=800A	1SDA101378R1	1SDA101666R1
	1000	Ekip Touch LSI	1000	XT7S M 1000 Ekip Touch LSI In=1000A	1SDA101379R1	1SDA101667R1
	1250	Ekip Touch LSI	1250	XT7S M 1250 Ekip Touch LSI In=1250A	1SDA101380R1	1SDA101668R1
	1600	Ekip Touch LSI	1600	XT7S M 1600 Ekip Touch LSI In=1600A	1SDA101381R1	1SDA101669R1



XT7 M - circuit-breaker

SACE XT7S M (50 kA) Ekip Touch LSI - Front terminals (F)

Size	lu	Trip units	In	Type	3 poles	4 poles
					Code	Code
XT7	800	Ekip Touch LSI	800	XT7S M 800 Ekip Touch LSI In=800A	1SDA101382R1	1SDA101670R1
	1000	Ekip Touch LSI	1000	XT7S M 1000 Ekip Touch LSI In=1000A	1SDA101383R1	1SDA101671R1
	1250	Ekip Touch LSI	1250	XT7S M 1250 Ekip Touch LSI In=1250A	1SDA101384R1	1SDA101672R1
	1600	Ekip Touch LSI	1600	XT7S M 1600 Ekip Touch LSI In=1600A	1SDA101385R1	1SDA101673R1

SACE XT7S M (50 kA) Ekip Touch Measuring LSI - Front terminals (F)

Size	lu	Trip units	In	Type	3 poles	4 poles
					Code	Code
XT7	800	Ekip Touch Meas.LSI	800	XT7S M 800 Ekip Touch Meas.LSI In=800A	1SDA101386R1	1SDA101674R1
	1000	Ekip Touch Meas.LSI	1000	XT7S M 1000 Ekip Touch Meas.LSI In=1000A	1SDA101387R1	1SDA101675R1
	1250	Ekip Touch Meas.LSI	1250	XT7S M 1250 Ekip Touch Meas.LSI In=1250A	1SDA101388R1	1SDA101676R1
	1600	Ekip Touch Meas.LSI	1600	XT7S M 1600 Ekip Touch Meas.LSI In=1600A	1SDA101389R1	1SDA101677R1

SACE XT7S M (50 kA) Ekip Touch Measuring LSI - Front terminals (F)

Size	lu	Trip units	In	Type	3 poles	4 poles
					Code	Code
XT7	800	Ekip Touch Meas.LSI	800	XT7S M 800 Ekip Touch Meas.LSI In=800A	1SDA101390R1	1SDA101678R1
	1000	Ekip Touch Meas.LSI	1000	XT7S M 1000 Ekip Touch Meas.LSI In=1000A	1SDA101391R1	1SDA101679R1
	1250	Ekip Touch Meas.LSI	1250	XT7S M 1250 Ekip Touch Meas.LSI In=1250A	1SDA101392R1	1SDA101680R1
	1600	Ekip Touch Meas.LSI	1600	XT7S M 1600 Ekip Touch Meas.LSI In=1600A	1SDA101393R1	1SDA101681R1

SACE XT7S M (50 kA) Ekip Hi-Touch LSI - Front terminals (F)

Size	lu	Trip units	In	Type	3 poles	4 poles
					Code	Code
XT7	800	Ekip Hi-Touch LSI	800	XT7S M 800 Ekip Hi-Touch LSI In=800A	1SDA101394R1	1SDA101682R1
	1000	Ekip Hi-Touch LSI	1000	XT7S M 1000 Ekip Hi-Touch LSI In=1000A	1SDA101395R1	1SDA101683R1
	1250	Ekip Hi-Touch LSI	1250	XT7S M 1250 Ekip Hi-Touch LSI In=1250A	1SDA101396R1	1SDA101684R1
	1600	Ekip Hi-Touch LSI	1600	XT7S M 1600 Ekip Hi-Touch LSI In=1600A	1SDA101397R1	1SDA101685R1

Ordering codes for XT7/XT7 M

Automatic circuit-breakers – XT7 M



XT7 M - circuit-breaker

SACE XT7S M (50 kA) Ekip Hi-Touch LSIG - Front terminals (F)

Size	Iu	Trip units	In	Type	3 poles	4 poles
					Code	Code
XT7	800	Ekip Hi-Touch LSIG	800	XT7S M 800 Ekip Hi-Touch LSIG In=800A	1SDA101398R1	1SDA101686R1
	1000	Ekip Hi-Touch LSIG	1000	XT7S M 1000 Ekip Hi-Touch LSIG In=1000A	1SDA101399R1	1SDA101687R1
	1250	Ekip Hi-Touch LSIG	1250	XT7S M 1250 Ekip Hi-Touch LSIG In=1250A	1SDA101400R1	1SDA101688R1
	1600	Ekip Hi-Touch LSIG	1600	XT7S M 1600 Ekip Hi-Touch LSIG In=1600A	1SDA101401R1	1SDA101689R1

Motor protection circuit-breakers

SACE XT7S M (50 kA) Ekip M Dip I - Front terminals (F)

Size	Iu	Trip units	In	Type	3 poles	4 poles
					Code	Code
XT7	800	Ekip M Dip I	800	XT7S M 800 Ekip M Dip I In=800A	1SDA101402R1	
	1000	Ekip M Dip I	1000	XT7S M 1000 Ekip M Dip I In=1000A	1SDA101403R1	
	1250	Ekip M Dip I	1250	XT7S M 1250 Ekip M Dip I In=1250A	1SDA101404R1	
	1600	Ekip M Dip I	1600	XT7S M 1600 Ekip M Dip I In=1600A	1SDA101405R1	

SACE XT7S M (50 kA) Ekip M Touch LRIU - Front terminals (F)

Size	Iu	Trip units	In	Type	3 poles	4 poles
					Code	Code
XT7	800	Ekip M Touch LRIU	800	XT7S M 800 Ekip M Touch LRIU In=800A	1SDA101406R1	
	1000	Ekip M Touch LRIU	1000	XT7S M 1000 Ekip M Touch LRIU In=1000A	1SDA101407R1	
	1250	Ekip M Touch LRIU	1250	XT7S M 1250 Ekip M Touch LRIU In=1250A	1SDA101408R1	
	1600	Ekip M Touch LRIU	1600	XT7S M 1600 Ekip M Touch LRIU In=1600A	1SDA101409R1	



XT7 M - circuit-breaker

Generator protection circuit-breakers



XT7 M - circuit-breaker

SACE XT7S M (50 kA) Ekip G Dip LS/I - Front terminals (F)

Size	lu	Trip units	In	Type	3 poles	4 poles
					Code	Code
XT7	800	Ekip G Dip LS/I	800	XT7S M 800 Ekip G Dip LS/I In=800A	1SDA101410R1	1SDA101690R1
	1000	Ekip G Dip LS/I	1000	XT7S M 1000 Ekip G Dip LS/I In=1000A	1SDA101411R1	1SDA101691R1
	1250	Ekip G Dip LS/I	1250	XT7S M 1250 Ekip G Dip LS/I In=1250A	1SDA101412R1	1SDA101692R1
	1600	Ekip G Dip LS/I	1600	XT7S M 1600 Ekip G Dip LS/I In=1600A	1SDA101413R1	1SDA101693R1

SACE XT7S M (50 kA) Ekip G Touch LSIG- Front terminals (F)

Size	lu	Trip units	In	Type	3 poles	4 poles
					Code	Code
XT7	800	Ekip G Touch LSIG	800	XT7S M 800 Ekip G Touch LSIG In=800A	1SDA101414R1	1SDA101694R1
	1000	Ekip G Touch LSIG	1000	XT7S M 1000 Ekip G Touch LSIG In=1000	1SDA101415R1	1SDA101695R1
	1250	Ekip G Touch LSIG	1250	XT7S M 1250 Ekip G Touch LSIG In=1250	1SDA101416R1	1SDA101696R1
	1600	Ekip G Touch LSIG	1600	XT7S M 1600 Ekip G Touch LSIG In=1600	1SDA101417R1	1SDA101697R1

SACE XT7S M (50 kA) Ekip G Hi-Touch LSIG - Front terminals (F)

Size	lu	Trip units	In	Type	3 poles	4 poles
					Code	Code
XT7	800	Ekip G Hi-Touch LSIG	800	XT7S M 800 Ekip G Hi-Touch LSIG In=800A	1SDA101418R1	1SDA101698R1
	1000	Ekip G Hi-Touch LSIG	1000	XT7S M 1000 Ekip G Hi-TouchLSIG In=1000A	1SDA101419R1	1SDA101699R1
	1250	Ekip G Hi-Touch LSIG	1250	XT7S M 1250 Ekip G Hi-TouchLSIG In=1250A	1SDA101420R1	1SDA101700R1
	1600	Ekip G Hi-Touch LSIG	1600	XT7S M 1600 Ekip G Hi-TouchLSIG In=1600A	1SDA101421R1	1SDA101701R1

Ordering codes for XT7/XT7 M

Automatic circuit-breakers – XT7 M

Distribution circuit-breakers

SACE XT7H M (70 kA) Ekip Dip LS/I - Front terminals (F)

Size	lu	Trip units	In	Type	3 poles	4 poles
					Code	Code
XT7	800	Ekip Dip LS/I	800	XT7H M 800 Ekip Dip LS/I In=800A	1SDA101430R1	1SDA101710R1
	1000	Ekip Dip LS/I	1000	XT7H M 1000 Ekip Dip LS/I In=1000A	1SDA101431R1	1SDA101711R1
	1250	Ekip Dip LS/I	1250	XT7H M 1250 Ekip Dip LS/I In=1250A	1SDA101432R1	1SDA101712R1
	1600	Ekip Dip LS/I	1600	XT7H M 1600 Ekip Dip LS/I In=1600A	1SDA101433R1	1SDA101713R1



XT7 M - circuit-breaker

SACE XT7H M (70 kA) Ekip Dip LSI - Front terminals (F)

Size	lu	Trip units	In	Type	3 poles	4 poles
					Code	Code
XT7	800	Ekip Dip LSI	800	XT7H M 800 Ekip Dip LSI In=800A	1SDA101434R1	1SDA101714R1
	1000	Ekip Dip LSI	1000	XT7H M 1000 Ekip Dip LSI In=1000A	1SDA101435R1	1SDA101715R1
	1250	Ekip Dip LSI	1250	XT7H M 1250 Ekip Dip LSI In=1250A	1SDA101436R1	1SDA101716R1
	1600	Ekip Dip LSI	1600	XT7H M 1600 Ekip Dip LSI In=1600A	1SDA101437R1	1SDA101717R1

SACE XT7H M (70 kA) Ekip Dip LSIG - Front terminals (F)

Size	lu	Trip units	In	Type	3 poles	4 poles
					Code	Code
XT7	800	Ekip Dip LSIG	800	XT7H M 800 Ekip Dip LSIG In=800A	1SDA101438R1	1SDA101718R1
	1000	Ekip Dip LSIG	1000	XT7H M 1000 Ekip Dip LSIG In=1000A	1SDA101439R1	1SDA101719R1
	1250	Ekip Dip LSIG	1250	XT7H M 1250 Ekip Dip LSIG In=1250A	1SDA101440R1	1SDA101720R1
	1600	Ekip Dip LSIG	1600	XT7H M 1600 Ekip Dip LSIG In=1600A	1SDA101441R1	1SDA101721R1

SACE XT7H M (70 kA) Ekip Dip LIG - Front terminals (F)

Size	lu	Trip units	In	Type	3 poles	4 poles
					Code	Code
XT7	800	Ekip Dip LIG	800	XT7H M 800 Ekip Dip LIG In=800A	1SDA101490R1	1SDA101762R1
	1000	Ekip Dip LIG	1000	XT7H M 1000 Ekip Dip LIG In=1000A	1SDA101491R1	1SDA101763R1
	1250	Ekip Dip LIG	1250	XT7H M 1250 Ekip Dip LIG In=1250A	1SDA101492R1	1SDA101764R1
	1600	Ekip Dip LIG	1600	XT7H M 1600 Ekip Dip LIG In=1600A	1SDA101493R1	1SDA101765R1

SACE XT7H M (70 kA) Ekip Touch LSI - Front terminals (F)

Size	lu	Trip units	In	Type	3 poles	4 poles
					Code	Code
XT7	800	Ekip Touch LSI	800	XT7H M 800 Ekip Touch LSI In=800A	1SDA101442R1	1SDA101722R1
	1000	Ekip Touch LSI	1000	XT7H M 1000 Ekip Touch LSI In=1000A	1SDA101443R1	1SDA101723R1
	1250	Ekip Touch LSI	1250	XT7H M 1250 Ekip Touch LSI In=1250A	1SDA101444R1	1SDA101724R1
	1600	Ekip Touch LSI	1600	XT7H M 1600 Ekip Touch LSI In=1600A	1SDA101445R1	1SDA101725R1



XT7 M - circuit-breaker

SACE XT7H M (70 kA) Ekip Touch LSIg - Front terminals (F)

Size	lu	Trip units	In	Type	3 poles	4 poles
					Code	Code
XT7	800	Ekip Touch LSIg	800	XT7H M 800 Ekip Touch LSIg In=800A	1SDA101446R1	1SDA101726R1
	1000	Ekip Touch LSIg	1000	XT7H M 1000 Ekip Touch LSIg In=1000A	1SDA101447R1	1SDA101727R1
	1250	Ekip Touch LSIg	1250	XT7H M 1250 Ekip Touch LSIg In=1250A	1SDA101448R1	1SDA101728R1
	1600	Ekip Touch LSIg	1600	XT7H M 1600 Ekip Touch LSIg In=1600A	1SDA101449R1	1SDA101729R1

SACE XT7H M (70 kA) Ekip Touch Measuring LSI - Front terminals (F)

Size	lu	Trip units	In	Type	3 poles	4 poles
					Code	Code
XT7	800	Ekip Touch Meas.LSI	800	XT7H M 800 Ekip Touch Meas.LSI In=800A	1SDA101450R1	1SDA101730R1
	1000	Ekip Touch Meas.LSI	1000	XT7H M 1000 Ekip Touch Meas.LSI In=1000A	1SDA101451R1	1SDA101731R1
	1250	Ekip Touch Meas.LSI	1250	XT7H M 1250 Ekip Touch Meas.LSI In=1250A	1SDA101452R1	1SDA101732R1
	1600	Ekip Touch Meas.LSI	1600	XT7H M 1600 Ekip Touch Meas.LSI In=1600A	1SDA101453R1	1SDA101733R1

SACE XT7H M (70 kA) Ekip Touch Measuring LSIg - Front terminals (F)

Size	lu	Trip units	In	Type	3 poles	4 poles
					Code	Code
XT7	800	Ekip Touch Meas.LSIg	800	XT7H M 800 Ekip Touch Meas.LSIg In=800A	1SDA101454R1	1SDA101734R1
	1000	Ekip Touch Meas.LSIg	1000	XT7H M 1000 Ekip Touch Meas.LSIg In=1000A	1SDA101455R1	1SDA101735R1
	1250	Ekip Touch Meas.LSIg	1250	XT7H M 1250 Ekip Touch Meas.LSIg In=1250A	1SDA101456R1	1SDA101736R1
	1600	Ekip Touch Meas.LSIg	1600	XT7H M 1600 Ekip Touch Meas.LSIg In=1600A	1SDA101457R1	1SDA101737R1

SACE XT7H M (70 kA) Ekip Hi-Touch LSI - Front terminals (F)

Size	lu	Trip units	In	Type	3 poles	4 poles
					Code	Code
XT7	800	Ekip Hi-Touch LSI	800	XT7H M 800 Ekip Hi-Touch LSI In=800A	1SDA101458R1	1SDA101738R1
	1000	Ekip Hi-Touch LSI	1000	XT7H M 1000 Ekip Hi-Touch LSI In=1000A	1SDA101459R1	1SDA101739R1
	1250	Ekip Hi-Touch LSI	1250	XT7H M 1250 Ekip Hi-Touch LSI In=1250A	1SDA101460R1	1SDA101740R1
	1600	Ekip Hi-Touch LSI	1600	XT7H M 1600 Ekip Hi-Touch LSI In=1600A	1SDA101461R1	1SDA101741R1

Ordering codes for XT7/XT7 M

Automatic circuit-breakers – XT7 M



XT7 M - circuit-breaker

SACE XT7H M (70 kA) Ekip Hi-Touch LSIG - Front terminals (F)

Size	lu	Trip units	In	Type	3 poles	4 poles
					Code	Code
XT7	800	Ekip Hi-Touch LSIG	800	XT7H M 800 Ekip Hi-Touch LSIG In=800A	1SDA101462R1	1SDA101742R1
	1000	Ekip Hi-Touch LSIG	1000	XT7H M 1000 Ekip Hi-Touch LSIG In=1000A	1SDA101463R1	1SDA101743R1
	1250	Ekip Hi-Touch LSIG	1250	XT7H M 1250 Ekip Hi-Touch LSIG In=1250A	1SDA101464R1	1SDA101744R1
	1600	Ekip Hi-Touch LSIG	1600	XT7H M 1600 Ekip Hi-Touch LSIG In=1600A	1SDA101465R1	1SDA101745R1

Motor protection circuit-breakers

SACE XT7H M (70 kA) Ekip M Dip I - Front terminals (F)

Size	lu	Trip units	In	Type	3 poles	4 poles
					Code	Code
XT7	800	Ekip M Dip I	800	XT7H M 800 Ekip M Dip I In=800A	1SDA101466R1	
	1000	Ekip M Dip I	1000	XT7H M 1000 Ekip M Dip I In=1000A	1SDA101467R1	
	1250	Ekip M Dip I	1250	XT7H M 1250 Ekip M Dip I In=1250A	1SDA101468R1	
	1600	Ekip M Dip I	1600	XT7H M 1600 Ekip M Dip I In=1600A	1SDA101469R1	

SACE XT7H M (70 kA) Ekip M Touch LRIU - Front terminals (F)

Size	lu	Trip units	In	Type	3 poles	4 poles
					Code	Code
XT7	800	Ekip M Touch LRIU	800	XT7H M 800 Ekip M Touch LRIU In=800A	1SDA101470R1	
	1000	Ekip M Touch LRIU	1000	XT7H M 1000 Ekip M Touch LRIU In=1000A	1SDA101471R1	
	1250	Ekip M Touch LRIU	1250	XT7H M 1250 Ekip M Touch LRIU In=1250A	1SDA101472R1	
	1600	Ekip M Touch LRIU	1600	XT7H M 1600 Ekip M Touch LRIU In=1600A	1SDA101473R1	



XT7 M - circuit-breaker

Generator protection circuit-breakers



XT7 M - circuit-breaker

SACE XT7H M (70 kA) Ekip G Dip LS/I - Front terminals (F)

Size	lu	Trip units	In	Type	3 poles	4 poles
					Code	Code
XT7	800	Ekip G Dip LS/I	800	XT7H M 800 Ekip G Dip LS/I In=800A	1SDA101474R1	1SDA101746R1
	1000	Ekip G Dip LS/I	1000	XT7H M 1000 Ekip G Dip LS/I In=1000A	1SDA101475R1	1SDA101747R1
	1250	Ekip G Dip LS/I	1250	XT7H M 1250 Ekip G Dip LS/I In=1250A	1SDA101476R1	1SDA101748R1
	1600	Ekip G Dip LS/I	1600	XT7H M 1600 Ekip G Dip LS/I In=1600A	1SDA101477R1	1SDA101749R1

SACE XT7H M (70 kA) Ekip G Touch LSIG - Front terminals (F)

Size	lu	Trip units	In	Type	3 poles	4 poles
					Code	Code
XT7	800	Ekip G Touch LSIG	800	XT7H M 800 Ekip G Touch LSIG In=800A	1SDA101478R1	1SDA101750R1
	1000	Ekip G Touch LSIG	1000	XT7H M 1000 Ekip G Touch LSIG In=1000A	1SDA101479R1	1SDA101751R1
	1250	Ekip G Touch LSIG	1250	XT7H M 1250 Ekip G Touch LSIG In=1250A	1SDA101480R1	1SDA101752R1
	1600	Ekip G Touch LSIG	1600	XT7H M 1600 Ekip G Touch LSIG In=1600A	1SDA101481R1	1SDA101753R1

SACE XT7H M (70 kA) Ekip G Hi-Touch LSIG - Front terminals (F)

Size	lu	Trip units	In	Type	3 poles	4 poles
					Code	Code
XT7	800	Ekip G Hi-Touch LSIG	800	XT7H M 800 Ekip G Hi-Touch LSIG In=800A	1SDA101482R1	1SDA101754R1
	1000	Ekip G Hi-Touch LSIG	1000	XT7H M 1000 Ekip G Hi-TouchLSIG In=1000A	1SDA101483R1	1SDA101755R1
	1250	Ekip G Hi-Touch LSIG	1250	XT7H M 1250 Ekip G Hi-TouchLSIG In=1250A	1SDA101484R1	1SDA101756R1
	1600	Ekip G Hi-Touch LSIG	1600	XT7H M 1600 Ekip G Hi-TouchLSIG In=1600A	1SDA101485R1	1SDA101757R1

Ordering codes for XT7/XT7 M

Automatic circuit-breakers – XT7 M

Distribution circuit-breakers

SACE XT7L M (120 kA) Ekip Dip LS/I - Front terminals (F)

Size	lu	Trip units	In	Type	3 poles	4 poles
					Code	Code
XT7	800	Ekip Dip LS/I	800	XT7L M 800 Ekip Dip LS/I In=800A	1SDA101494R1	1SDA101766R1
	1000	Ekip Dip LS/I	1000	XT7L M 1000 Ekip Dip LS/I In=1000A	1SDA101495R1	1SDA101767R1
	1250	Ekip Dip LS/I	1250	XT7L M 1250 Ekip Dip LS/I In=1250A	1SDA101496R1	1SDA101768R1
	1600	Ekip Dip LS/I	1600	XT7L M 1600 Ekip Dip LS/I In=1600A	1SDA101497R1	1SDA101769R1

SACE XT7L M (120 kA) Ekip Dip LSI - Front terminals (F)

Size	lu	Trip units	In	Type	3 poles	4 poles
					Code	Code
XT7	800	Ekip Dip LSI	800	XT7L M 800 Ekip Dip LSI In=800A	1SDA101498R1	1SDA101770R1
	1000	Ekip Dip LSI	1000	XT7L M 1000 Ekip Dip LSI In=1000A	1SDA101499R1	1SDA101771R1
	1250	Ekip Dip LSI	1250	XT7L M 1250 Ekip Dip LSI In=1250A	1SDA101500R1	1SDA101772R1
	1600	Ekip Dip LSI	1600	XT7L M 1600 Ekip Dip LSI In=1600A	1SDA101501R1	1SDA101773R1

SACE XT7L M (120 kA) Ekip Dip LSIG - Front terminals (F)

Size	lu	Trip units	In	Type	3 poles	4 poles
					Code	Code
XT7	800	Ekip Dip LSIG	800	XT7L M 800 Ekip Dip LSIG In=800A	1SDA101502R1	1SDA101774R1
	1000	Ekip Dip LSIG	1000	XT7L M 1000 Ekip Dip LSIG In=1000A	1SDA101503R1	1SDA101775R1
	1250	Ekip Dip LSIG	1250	XT7L M 1250 Ekip Dip LSIG In=1250A	1SDA101504R1	1SDA101776R1
	1600	Ekip Dip LSIG	1600	XT7L M 1600 Ekip Dip LSIG In=1600A	1SDA101505R1	1SDA101777R1

SACE XT7L M (120 kA) Ekip Dip LIG - Front terminals (F)

Size	lu	Trip units	In	Type	3 poles	4 poles
					Code	Code
XT7	800	Ekip Dip LIG	800	XT7L M 800 Ekip Dip LIG In=800A	1SDA101554R1	1SDA101818R1
	1000	Ekip Dip LIG	1000	XT7L M 1000 Ekip Dip LIG In=1000A	1SDA101555R1	1SDA101819R1
	1250	Ekip Dip LIG	1250	XT7L M 1250 Ekip Dip LIG In=1250A	1SDA101556R1	1SDA101820R1
	1600	Ekip Dip LIG	1600	XT7L M 1600 Ekip Dip LIG In=1600A	1SDA101557R1	1SDA101821R1

SACE XT7L M (120 kA) Ekip Touch LSI - Front terminals (F)

Size	lu	Trip units	In	Type	3 poles	4 poles
					Code	Code
XT7	800	Ekip Touch LSI	800	XT7L M 800 Ekip Touch LSI In=800A	1SDA101506R1	1SDA101778R1
	1000	Ekip Touch LSI	1000	XT7L M 1000 Ekip Touch LSI In=1000A	1SDA101507R1	1SDA101779R1
	1250	Ekip Touch LSI	1250	XT7L M 1250 Ekip Touch LSI In=1250A	1SDA101508R1	1SDA101780R1
	1600	Ekip Touch LSI	1600	XT7L M 1600 Ekip Touch LSI In=1600A	1SDA101509R1	1SDA101781R1



XT7 M - circuit-breaker



XT7 M - circuit-breaker

SACE XT7L M (120 kA) Ekip Touch LSI - Front terminals (F)

Size	lu	Trip units	In	Type	3 poles	4 poles
					Code	Code
XT7	800	Ekip Touch LSI	800	XT7L M 800 Ekip Touch LSI In=800A	1SDA101510R1	1SDA101782R1
	1000	Ekip Touch LSI	1000	XT7L M 1000 Ekip Touch LSI In=1000A	1SDA101511R1	1SDA101783R1
	1250	Ekip Touch LSI	1250	XT7L M 1250 Ekip Touch LSI In=1250A	1SDA101512R1	1SDA101784R1
	1600	Ekip Touch LSI	1600	XT7L M 1600 Ekip Touch LSI In=1600A	1SDA101513R1	1SDA101785R1

SACE XT7L M (120 kA) Ekip Touch Measuring LSI - Front terminals (F)

Size	lu	Trip units	In	Type	3 poles	4 poles
					Code	Code
XT7	800	Ekip Touch Meas.LSI	800	XT7L M 800 Ekip Touch Meas.LSI In=800A	1SDA101514R1	1SDA101786R1
	1000	Ekip Touch Meas.LSI	1000	XT7L M 1000 Ekip Touch Meas.LSI In=1000A	1SDA101515R1	1SDA101787R1
	1250	Ekip Touch Meas.LSI	1250	XT7L M 1250 Ekip Touch Meas.LSI In=1250A	1SDA101516R1	1SDA101788R1
	1600	Ekip Touch Meas.LSI	1600	XT7L M 1600 Ekip Touch Meas.LSI In=1600A	1SDA101517R1	1SDA101789R1

SACE XT7L M (120 kA) Ekip Touch Measuring LSI - Front terminals (F)

Size	lu	Trip units	In	Type	3 poles	4 poles
					Code	Code
XT7	800	Ekip Touch Meas.LSIG	800	XT7L M 800 Ekip Touch Meas.LSIG In=800A	1SDA101518R1	1SDA101790R1
	1000	Ekip Touch Meas.LSIG	1000	XT7L M 1000 Ekip Touch Meas.LSIG In=1000A	1SDA101519R1	1SDA101791R1
	1250	Ekip Touch Meas.LSIG	1250	XT7L M 1250 Ekip Touch Meas.LSIG In=1250A	1SDA101520R1	1SDA101792R1
	1600	Ekip Touch Meas.LSIG	1600	XT7L M 1600 Ekip Touch Meas.LSIG In=1600A	1SDA101521R1	1SDA101793R1

SACE XT7L M (120 kA) Ekip Hi-Touch LSI - Front terminals (F)

Size	lu	Trip units	In	Type	3 poles	4 poles
					Code	Code
XT7	800	Ekip Hi-Touch LSI	800	XT7L M 800 Ekip Hi-Touch LSI In=800A	1SDA101522R1	1SDA101794R1
	1000	Ekip Hi-Touch LSI	1000	XT7L M 1000 Ekip Hi-Touch LSI In=1000A	1SDA101523R1	1SDA101795R1
	1250	Ekip Hi-Touch LSI	1250	XT7L M 1250 Ekip Hi-Touch LSI In=1250A	1SDA101524R1	1SDA101796R1
	1600	Ekip Hi-Touch LSI	1600	XT7L M 1600 Ekip Hi-Touch LSI In=1600A	1SDA101525R1	1SDA101797R1

Ordering codes for XT7/XT7 M

Automatic circuit-breakers – XT7 M



XT7 M - circuit-breaker

SACE XT7L M (120 kA) Ekip Hi-Touch LSIG - Front terminals (F)

Size	lu	Trip units	In	Type	3 poles	4 poles
					Code	Code
XT7	800	Ekip Hi-Touch LSIG	800	XT7L M 800 Ekip Hi-Touch LSIG In=800A	1SDA101526R1	1SDA101798R1
	1000	Ekip Hi-Touch LSIG	1000	XT7L M 1000 Ekip Hi-Touch LSIG In=1000A	1SDA101527R1	1SDA101799R1
	1250	Ekip Hi-Touch LSIG	1250	XT7L M 1250 Ekip Hi-Touch LSIG In=1250A	1SDA101528R1	1SDA101800R1
	1600	Ekip Hi-Touch LSIG	1600	XT7L M 1600 Ekip Hi-Touch LSIG In=1600A	1SDA101529R1	1SDA101801R1

Motor protection circuit-breakers

SACE XT7L M (120 kA) Ekip M Dip I - Front terminals (F)

Size	lu	Trip units	In	Type	3 poles	4 poles
					Code	Code
XT7	800	Ekip M Dip I	800	XT7L M 800 Ekip M Dip I In=800A	1SDA101530R1	
	1000	Ekip M Dip I	1000	XT7L M 1000 Ekip M Dip I In=1000A	1SDA101531R1	
	1250	Ekip M Dip I	1250	XT7L M 1250 Ekip M Dip I In=1250A	1SDA101532R1	
	1600	Ekip M Dip I	1600	XT7L M 1600 Ekip M Dip I In=1600A	1SDA101533R1	

SACE XT7L M (120 kA) Ekip M Touch LRIU - Front terminals (F)

Size	lu	Trip units	In	Type	3 poles	4 poles
					Code	Code
XT7	800	Ekip M Touch LRIU	800	XT7L M 800 Ekip M Touch LRIU In=800A	1SDA101534R1	
	1000	Ekip M Touch LRIU	1000	XT7L M 1000 Ekip M Touch LRIU In=1000A	1SDA101535R1	
	1250	Ekip M Touch LRIU	1250	XT7L M 1250 Ekip M Touch LRIU In=1250A	1SDA101536R1	
	1600	Ekip M Touch LRIU	1600	XT7L M 1600 Ekip M Touch LRIU In=1600A	1SDA101537R1	



XT7 M - circuit-breaker

Generator protection circuit-breakers



XT7 M - circuit-breaker

SACE XT7L M (120 kA) Ekip G Dip LS/I - Front terminals (F)

Size	lu	Trip units	In	Type	3 poles	4 poles
					Code	Code
XT7	800	Ekip G Dip LS/I	800	XT7L M 800 Ekip G Dip LS/I In=800A	1SDA101538R1	1SDA101802R1
	1000	Ekip G Dip LS/I	1000	XT7L M 1000 Ekip G Dip LS/I In1000A	1SDA101539R1	1SDA101803R1
	1250	Ekip G Dip LS/I	1250	XT7L M 1250 Ekip G Dip LS/I In1250A	1SDA101540R1	1SDA101804R1
	1600	Ekip G Dip LS/I	1600	XT7L M 1600 Ekip G Dip LS/I In1600A	1SDA101541R1	1SDA101805R1

SACE XT7L M (120 kA) Ekip G Touch LSIG- Front terminals (F)

Size	lu	Trip units	In	Type	3 poles	4 poles
					Code	Code
XT7	800	Ekip G Touch LSIG	800	XT7L M 800 Ekip G Touch LSIG In=800A	1SDA101542R1	1SDA101806R1
	1000	Ekip G Touch LSIG	1000	XT7L M 1000 Ekip G Touch LSIG In=1000	1SDA101543R1	1SDA101807R1
	1250	Ekip G Touch LSIG	1250	XT7L M 1250 Ekip G Touch LSIG In=1250	1SDA101544R1	1SDA101808R1
	1600	Ekip G Touch LSIG	1600	XT7L M 1600 Ekip G Touch LSIG In=1600	1SDA101545R1	1SDA101809R1

SACE XT7L M (120 kA) Ekip G Hi-Touch LSIG - Front terminals (F)

Size	lu	Trip units	In	Type	3 poles	4 poles
					Code	Code
XT7	800	Ekip G Hi-Touch LSIG	800	XT7L M 800 Ekip G Hi-Touch LSIG In=800A	1SDA101546R1	1SDA101810R1
	1000	Ekip G Hi-Touch LSIG	1000	XT7L M 1000 Ekip G Hi-TouchLSIG In=1000A	1SDA101547R1	1SDA101811R1
	1250	Ekip G Hi-Touch LSIG	1250	XT7L M 1250 Ekip G Hi-TouchLSIG In=1250A	1SDA101548R1	1SDA101812R1
	1600	Ekip G Hi-Touch LSIG	1600	XT7L M 1600 Ekip G Hi-TouchLSIG In=1600A	1SDA101549R1	1SDA101813R1

Ordering codes for XT7/XT7 M

Switch-disconnectors – XT7/XT7 M



XT7 -
switch-disconnector

SACE XT7/XT7 M - Switch-disconnectors

Size	Iu	Type	3 poles	4 poles
			Code	Code
XT7	1000	XT7D 1000	1SDA101906R1	1SDA101909R1
	1250	XT7D 1250	1SDA101907R1	1SDA101910R1
	1600	XT7D 1600	1SDA101908R1	1SDA101911R1
XT7 M	1000	XT7D M 1000	1SDA101912R1	1SDA101915R1
	1250	XT7D M 1250	1SDA101913R1	1SDA101916R1
	1600	XT7D M 1600	1SDA101914R1	1SDA101917R1

Ordering codes for XT7/XT7 M

Trip units – XT7/XT7 M

Trip Units - BASIC*

Trip units - Distribution protection



Ekip Dip Trip unit

Size	Type	3/4 poles
		Code
XT7/XT7 M	Ekip Dip LS/I	1SDA101918R1
	Ekip Dip LIG	1SDA101933R1

Trip units - Motor protection

Size	Type	3 poles
		Code
XT7/XT7 M	Ekip M Dip I	1SDA101927R1

Trip units - Generator protection

Size	Type	3/4 poles
		Code
XT7/XTM	Ekip G Dip LS/I	1SDA101929R1

Trip Units - OTHERS*

Trip units - Distribution protection



Ekip Dip Trip unit



Ekip Touch Trip unit

Size	Type	3/4 poles
		Code
XT7/XT7 M	Ekip Dip LSI	1SDA101919R1
	Ekip Dip LSIG	1SDA101920R1
	Ekip Touch LSI	1SDA101921R1
	Ekip Touch LSIG	1SDA101922R1
	Ekip Touch Measuring LSI	1SDA101923R1
	Ekip Touch Measuring LSIG	1SDA101924R1
	Ekip Hi-Touch LSI	1SDA101925R1
	Ekip Hi-Touch LSIG	1SDA101926R1

Trip units - Motor protection

Size	Type	3 poles
		Code
XT7/XT7 M	Ekip M Touch LRIU	1SDA101928R1

Trip units - Generator protection

Size	Type	3/4 poles
		Code
XT7/XTM	Ekip G Touch LSIG	1SDA101930R1
	Ekip G Hi-Touch LSIG	1SDA101931R1

* All the trip units can be interchanged only if are part of the same family: BASIC trip unit can not be upgraded with the others, the others can not be replaced with the basic. Dedicated rating plug are available (see table pag.8/132)

Ordering codes for accessories

Execution and installation

Fixed parts

Fixed part of plug-in (P) circuit-breaker



Fixed part of plug-in circuit-breaker

Size	Type	3 poles	4 poles
XT1	P FP EF	1SDA068183R1	1SDA068185R1
XT1	P FP HR/VR ⁽¹⁾	1SDA068184R1	1SDA068186R1
XT2	P FP EF	1SDA068187R1	1SDA068190R1
XT2	P FP HR/VR ⁽¹⁾	1SDA068189R1	1SDA068191R1
XT3	P FP EF	1SDA068192R1	1SDA068194R1
XT3	P FP HR/VR ⁽¹⁾	1SDA068193R1	1SDA068195R1
XT4	P FP EF	1SDA068196R1	1SDA068198R1
XT4	P FP HR/VR ⁽¹⁾	1SDA068197R1	1SDA068199R1
XT5	P FP 400A EF	1SDA104668R1	1SDA104672R1
XT5	P FP 400A HR/VR ⁽¹⁾	1SDA104670R1	1SDA104674R1
XT5	P FP 400A VR/VR	1SDA112961R1	1SDA112963R1
XT5	P FP 630A EF	1SDA104676R1	1SDA104679R1
XT5	P FP 630A HR	1SDA104677R1	1SDA104680R1
XT5	P FP 630A VR	1SDA104678R1	1SDA104681R1

(1) The terminals are factory-mounted in the horizontal position (HR)

Fixed part of plug-in (P) frame configurable

Size	Type	3 poles	4 poles
XT5	P FP 400A frame configurable	1SDA112953R1	1SDA112954R1
XT5	P FP 630A frame configurable	1SDA112955R1	1SDA112956R1

Fixed part of withdrawable (W) circuit-breaker



Fixed part of withdrawable circuit-breaker

Size	Type	3 poles	4 poles
XT2	W FP EF	1SDA068200R1	1SDA068202R1
XT2	W FP HR/VR ⁽¹⁾	1SDA068201R1	1SDA068203R1
XT4	W FP EF	1SDA068204R1	1SDA068206R1
XT4	W FP HR/VR ⁽¹⁾	1SDA068205R1	1SDA068207R1
XT5	W FP 400A EF	1SDA104682R1	1SDA104686R1
XT5	W FP 400A HR/VR ⁽¹⁾	1SDA104684R1	1SDA104688R1
XT5	W FP 400A VR/VR	1SDA112965R1	1SDA112967R1
XT5	W FP 630A EF	1SDA104690R1	1SDA104693R1
XT5	W FP 630A HR	1SDA104691R1	1SDA104694R1
XT5	W FP 630A VR	1SDA104692R1	1SDA104695R1
XT6 ⁽²⁾	W FP EF	1SDA104696R1	1SDA104699R1
XT6 ⁽²⁾	W FP HR	1SDA104697R1	1SDA104700R1
XT6 ⁽²⁾	W FP VR	1SDA104698R1	1SDA104701R1
XT7-XT7 M	W FP EF	1SDA104702R1	1SDA104704R1
XT7-XT7 M	W FP HR	1SDA104703R1	1SDA104705R1

(1) The terminals are factory-mounted in the horizontal position (HR)

(2) In max = 800A, not suitable for XT6 1000A



Fixed part of withdrawable XT7-XT7 M

Fixed part of withdrawable (W) frame configurable

Size	Type	3 poles	4 poles
XT5	XT5 W FP 400A frame configurable	1SDA112957R1	1SDA112958R1
XT5	XT5 W FP 630A frame configurable	1SDA112959R1	1SDA112960R1
XT6	XT6 W FP frame configurable	1SDA112969R1	1SDA112970R1

Conversion kits

Conversion kit to convert circuit-breaker from fixed to moving part of a plug-in unit



Conversion kit for turning a fixed circuit-breaker into the moving part of a plug-in circuit-breaker

Size	Type	3 poles	4 poles
XT1	P MP Kit	1SDA066276R1	1SDA066277R1
XT2	P MP Kit	1SDA066278R1	1SDA066279R1
XT3	P MP Kit	1SDA066280R1	1SDA066281R1
XT4	P MP Kit	1SDA066282R1	1SDA066283R1
XT5	P MP Kit 400A	1SDA104707R1	1SDA104708R1
XT5	P MP Kit 630A	1SDA104709R1	1SDA104710R1

Conversion kit to convert circuit-breaker from fixed to moving part of a withdrawable unit



Conversion kit for turning a fixed circuit-breaker into the moving part of a withdrawable circuit-breaker

Size	Type	3 poles	4 poles
XT2	W MP Kit	1SDA066284R1	1SDA066285R1
XT4	W MP Kit	1SDA066286R1	1SDA066287R1
XT5	W MP Kit 400A	1SDA104711R1	1SDA104712R1
XT5	W MP Kit 630A	1SDA104713R1	1SDA104714R1
XT6	W MP Kit	1SDA104715R1	1SDA104716R1
XT7-XT7 M	W MP Kit	1SDA104717R1	1SDA104718R1

Conversion kit to convert circuit-breaker fixed part from plug-in to a withdrawable unit



Conversion kit for turning a fixed part of plug-in version into a fixed part of withdrawable version circuit-breaker

Size	Type	Code
XT2	XT2 FP P>W Kit	1SDA066288R1
XT4	XT4 FP P>W Kit	1SDA066289R1
XT5	XT5 FP P>W Kit	1SDA104706R1

Conversion kit to convert an RC from fixed to a plug-in unit

Size	Type	Code
XT2	XT2 P MP RC Sel 4p Kit	1SDA066290R1
XT4	XT4 P MP RC Sel 4p Kit	1SDA066291R1
XT5	XT5 400A P MP RC Sel 4p Kit	1SDA104719R1
XT5	XT5 630A P MP RC Sel 4p Kit	1SDA104720R1

Conversion kit to convert an RC from a plug-in into a withdrawable unit

Size	Type	Code
XT2	XT2 W MP RC Sel 4p Kit	1SDA066292R1
XT4	XT4 W MP RC Sel 4p Kit	1SDA067115R1
XT5	XT5 400A W MP RC Sel 4p Kit	1SDA104721R1
XT5	XT5 630A W MP RC Sel 4p Kit	1SDA104722R1

Ordering codes for accessories

Execution and installation

Plug and socket adapters

Socket plug connector on rear of the panel

Size	Type	Code
XT1...XT6	Socket-plug panel connector with 3PINS	1SDA066409R1
XT1...XT6	Socket-plug panel connector with 6PINS	1SDA066410R1
XT1...XT6	Socket-plug panel connector with 9PINS	1SDA066411R1
XT1...XT6	Socket-plug panel connector with 15PINS	1SDA066412R1



Fixed part socket-plug connector

Fixed part socket-plug connector

Size	Type	Code
XT2-XT4-XT5-XT6	Socket-plug connector for Moving Part 12PINS	1SDA066413R1
XT2-XT4-XT5-XT6	Socket-plug connector for Fixed Part 12PINS	1SDA066414R1



Socket-plug panel connector

Bracket for fixing on DIN-rail

Bracket for fixing onto DIN-rail

Size	Type	3 poles	4 poles
XT1	KIT DIN50022	1SDA066652R1	1SDA066419R1
XT1	KIT DIN50022 + RC Low 200mm		1SDA067134R1
XT1	KIT DIN50022 +RC Sel/RC Inst	1SDA067135R1	1SDA067135R1
XT2	KIT DIN50022	1SDA080704R1	1SDA080325R1
XT3	KIT DIN50022	1SDA066420R1	1SDA066421R1
XT3	KIT DIN50022 + RC Inst / RC Sel	1SDA067139R1	1SDA067139R1
XT4	KIT DIN50022	1SDA080326R1	1SDA080327R1



DIN guide

Floor fixing plate

Cable rack

Size	Type	Code
XT7-XT7 M	Floor fixing plate for fixed unit	1SDA076020R1

Cable rack

Cable rack

Size	Type	Code
XT5-XT6	Cable rack for fixed and plug-in circuit-breaker	1SDA104729R1

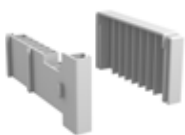

Cable rack

Ordering codes for accessories

Power connection

Terminals for circuit-breaker

Terminals for circuit-breaker



Front extended terminal - EF



Front extended spread terminal - ES



FCCu terminal



FCCuAl external terminal



FCCuAl internal terminal

Size	Type	pcs (1/2 kit for 3p)	pcs (1/2 kit for 4p)
XT1	F Front terminals	1SDA066849R1	1SDA066850R1
XT1	EF Extended front terminals	1SDA066865R1	1SDA066866R1
XT1	ES Extended spread front terminals	1SDA066889R1	1SDA066890R1
XT1	FC CuAl terminals for CuAl cables 1x1.5...70mm ²	1SDA067151R1	1SDA067152R1
XT1	FC CuAl terminals for CuAl cables 1x35...95mm ²	1SDA067155R1	1SDA067156R1
XT1	FC CuAl terminals for CuAl cables 1x120...240mm ² + ADP	1SDA067159R1 ⁽¹⁾	1SDA067160R1 ⁽¹⁾
XT1	FC Cu terminals for Cu cables	1SDA066905R1	1SDA066906R1
XT1	MC Multi-cable terminals 6x2.5...35mm ²	1SDA066921R1	1SDA066922R1
XT1	R Rear adjustable terminals	1SDA066937R1	1SDA066938R1
XT1	R-RC Rear terminals for residual current		1SDA066953R1
XT1	FB Flexible busbar terminals	1SDA066957R1	1SDA066958R1
XT2	F Front terminals	1SDA066853R1	1SDA066854R1
XT2	EF Extended front terminals	1SDA066869R1	1SDA066870R1
XT2	ES Extended spread front terminals	1SDA066893R1	1SDA066894R1
XT2	FC CuAl terminals for CuAl cables 1x1...95mm ²	1SDA067163R1	1SDA067164R1
XT2	FC CuAl terminals for CuAl cables 1x70...185mm ²	1SDA067167R1	1SDA067168R1
XT2	FC CuAl terminals for CuAl cables 1x120...240mm ² + ADP	1SDA067171R1 ⁽¹⁾	1SDA067172R1 ⁽¹⁾
XT2	FC CuAl terminals for CuAl cables 2x35... 95 mm ²	1SDA067175R1	1SDA067176R1
XT2	FC Cu terminals for Cu cables	1SDA066909R1	1SDA066910R1
XT2	MC Multi-cable terminals 6x2.5...35mm ²	1SDA066925R1	1SDA066926R1
XT2	R Rear adjustable terminals	1SDA066941R1	1SDA066942R1
XT2	FB Flexible busbar terminals	1SDA066961R1	1SDA066962R1
XT3	F Front terminals	1SDA066857R1	1SDA066858R1
XT3	EF Extended front terminals	1SDA066873R1	1SDA066874R1
XT3	ES Extended spread front terminals	1SDA066897R1	1SDA066898R1
XT3	FC CuAl terminals for CuAl cables 1x185mm ²	1SDA067179R1	1SDA067180R1
XT3	FC CuAl terminals for CuAl cables 1x120...240mm ² + ADP	1SDA067183R1 ⁽¹⁾	1SDA067184R1 ⁽¹⁾
XT3	FC CuAl terminals for CuAl cables 2x35...120mm ²	1SDA067187R1	1SDA067188R1
XT3	FC CuAl terminals for CuAl cables 1x35...150mm ²	1SDA066274R1	1SDA066275R1
XT3	FC Cu terminals for Cu cables	1SDA066913R1	1SDA066914R1
XT3	MC Multi-cable terminals 6x2.5...35mm ²	1SDA066929R1	1SDA066930R1
XT3	R Rear adjustable terminals	1SDA066945R1	1SDA066946R1
XT3	FB Flexible busbar terminals	1SDA066965R1	1SDA066966R1
XT3	R-RC Rear terminal for RC Inst-Sel		1SDA066954R1
XT4	F Front terminals	1SDA066861R1	1SDA066862R1
XT4	EF Extended front terminals	1SDA066877R1	1SDA066878R1
XT4	ES Extended spread front terminals	1SDA066901R1	1SDA066902R1
XT4	FC CuAl terminals for CuAl cables 1x1...150mm ²	1SDA067191R1	1SDA067192R1
XT4	FC CuAl terminals for CuAl cables 1x120...240mm ² + ADP	1SDA067195R1 ⁽¹⁾	1SDA067196R1 ⁽¹⁾
XT4	FC CuAl terminals for CuAl cables 2x35...150mm ²	1SDA067199R1	1SDA067200R1
XT4	FC Cu terminals for Cu cables	1SDA066917R1	1SDA066918R1
XT4	MC Multi-cable terminals 6x2.5...35mm ²	1SDA066933R1	1SDA066934R1
XT4	R Rear adjustable terminals	1SDA066949R1	1SDA066950R1
XT4	FB Flexible busbar terminals	1SDA066969R1	1SDA066970R1

Ordering codes for accessories

Power connection



Multi-cable terminal (MC)



Rear horizontal terminals (R)

Terminals for circuit-breaker

Size	Type	pcs (1/2 kit for 3p)	pcs (1/2 kit for 4p)
XT5	F Front terminals	1SDA104730R1	1SDA104731R1
XT5	EF Extended front terminals	1SDA104734R1	1SDA104735R1
XT5	ES Extended spread front terminals	1SDA104738R1	1SDA104739R1
XT5	XT5 FC CuAl 1x35...185mm ²	1SDA104746R1	1SDA104747R1
XT5	FC CuAl 1x120...240mm ²	1SDA104742R1	1SDA104743R1
XT5	FC CuAl 1x185...300mm ²	1SDA104744R1	1SDA104745R1
XT5	XT5 FC CuAl 2x70...240mm ²	1SDA104748R1	1SDA104749R1
XT5	R Rear adjustable terminals	1SDA104760R1	1SDA104761R1
XT6	F Front terminals	1SDA104732R1	1SDA104733R1
XT6	EF Extended front terminals 800A	1SDA104736R1	1SDA104737R1
XT6	EF Extended front terminals 1000A	1SDA10473R1	1SDA10474R1
XT6	XT6 ES Extended spread front terminals Upper	1SDA104740R1	1SDA104741R1
XT6	XT6 ES Extended spread front terminals Lower	1SDA113127R1	1SDA104741R1
XT6	FC CuAl 2x120...240mm ²	1SDA104750R1	1SDA104751R1
XT6	FC CuAl 3x70...185mm ²	1SDA104752R1	1SDA104753R1
XT6	FC CuAl 4x70...150mm ²	1SDA104754R1	1SDA104755R1
XT6	R Rear adjustable terminals	1SDA104762R1	1SDA104763R1

Terminals loose supply for fixed circuit-breaker

Size	Type	3 pcs (1/2 kit for 3p)	4 pcs (1/2 kit for 4p)
XT7-XT7 M	F Front terminals	1SDA073973R1	1SDA073974R1
XT7-XT7 M	EF Extended front terminals	1SDA073967R1	1SDA073968R1
XT7-XT7 M	ES Extended spread front terminals	1SDA073979R1	1SDA073980R1
XT7-XT7 M	XT7-XT7M ES Extended spread front terminals	1SDA076076R1	1SDA073980R1
XT7-XT7 M	FC CuAl 2x240mm ²	1SDA104756R1	1SDA104757R1
XT7-XT7 M	FC CuAl 4x240mm ²	1SDA104758R1	1SDA104759R1
XT7-XT7 M	XT7-XT7 M FC CuAl 3x380mm ²	1SDA113119R1	1SDA113120R1
XT7-XT7 M	HR/VR – Rear terminals	1SDA073989R1	1SDA073990R1

Terminals installed for fixed circuit-breaker

Size	Type	3 pcs (1/2 kit for 3p)	4 pcs (1/2 kit for 4p)
XT7-XT7 M	EF Extended front terminals Upper	1SDA073963R1	1SDA073964R1
XT7-XT7 M	EF Extended front terminals Lower	1SDA073965R1	1SDA073966R1
XT7-XT7 M	ES Extended spread front terminals Upper	1SDA073975R1	1SDA073976R1
XT7-XT7 M	ES Extended spread front terminals Lower	1SDA073977R1	1SDA073978R1
XT7-XT7 M	HR-Rear horizontal terminals Upper	1SDA073981R1	1SDA073982R1
XT7-XT7 M	HR-Rear horizontal terminals Lower	1SDA073983R1	1SDA073984R1
XT7-XT7 M	VR-Rear vertical terminals Upper	1SDA073985R1	1SDA073986R1
XT7-XT7 M	VR-Rear vertical terminals Lower	1SDA073987R1	1SDA073988R1
XT7-XT7 M	FC CuAl 4x120...240mm ² Upper	1SDA073997R1	1SDA073998R1
XT7-XT7 M	FC CuAl 4x120...240mm ² Lower	1SDA073999R1	1SDA074000R1
XT7-XT7 M	FC CuAl 2x185...240mm ² XT7 Upper INST	1SDA107753R1	1SDA107755R1
XT7-XT7 M	FC CuAl 2x185...240mm ² XT7 Lower INST	1SDA107754R1	1SDA107756R1
XT7-XT7 M	FC CuAl 3x240...380mm ² Upper	1SDA113121R1	1SDA113122R1
XT7-XT7 M	FC CuAl 3x240...380mm ² Lower	1SDA113123R1	1SDA113124R1

Terminals for fixed parts

Terminals for the fixed parts



—
EF terminal for
fixed part



—
HR terminals for
fixed part

Size	Type	pcs (1/2 kit for 3p)	pcs (1/2 kit for 4p)
XT1	EF – Front extended terminals	1SDA066260R1	1SDA066261R1
XT1	HR/VR – Rear terminals	1SDA066268R1	1SDA066269R1
XT2	EF – Front extended terminals	1SDA066262R1	1SDA066263R1
XT2	HR/VR – Rear terminals	1SDA066270R1	1SDA066271R1
XT3	EF – Front extended terminals	1SDA066264R1	1SDA066265R1
XT3	HR/VR – Rear terminals	1SDA066272R1	1SDA066273R1
XT4	EF – Front extended terminals	1SDA066266R1	1SDA066267R1
XT4	HR/VR – Rear terminals	1SDA066272R1	1SDA066273R1
XT5	EF – Front extended terminals 400A	1SDA104764R1	1SDA104765R1
XT5	HR/VR – Rear terminals IEC 400A	1SDA104775R1	1SDA104778R1
XT5	HR/VR – Rear terminals (same length) 400A	1SDA104774R1	1SDA104777R1
XT5	EF – Front extended terminals 630A	1SDA104766R1	1SDA104767R1
XT5	HR – Rear horizontal terminals 630A	1SDA104770R1	1SDA104771R1
XT5	VR – Rear vertical terminals 630A	1SDA104780R1	1SDA104781R1
XT6	EF – Front extended terminals	1SDA104768R1	1SDA104769R1
XT6	HR – Rear horizontal terminals	1SDA104772R1	1SDA104773R1
XT6	VR – Rear vertical terminals	1SDA104782R1	1SDA104783R1

Terminals loose supply for fixed parts

Size	Type	3 pcs (1/2 kit for 3p)	4 pcs (1/2 kit for 4p)
XT7-XT7 M	EF – Front extended terminals	1SDA073943R1	1SDA073944R1
XT7-XT7 M	ES – Front extended spread terminals	1SDA073955R1	1SDA073956R1
XT7-XT7 M	HR/VR – Rear terminals	1SDA107715R1	1SDA107716R1
XT7-XT7 M	SHR – Rear spread horizontal terminals	1SDA073961R1	1SDA073962R1
XT7-XT7 M	FC CuAl 4x240mm ² terminals	1SDA073995R1	1SDA073996R1

Terminals installed for fixed parts

Size	Type	3 pcs (1/2 kit for 3p)	4 pcs (1/2 kit for 4p)
XT7-XT7 M	EF Extended front terminals Upper	1SDA073939R1	1SDA073940R1
XT7-XT7 M	EF Extended front terminals Lower	1SDA073941R1	1SDA073942R1
XT7-XT7 M	ES Extended spread front terminals Upper	1SDA073951R1	1SDA073952R1
XT7-XT7 M	ES Extended spread front terminals Lower	1SDA073953R1	1SDA073954R1
XT7-XT7 M	SHR-Rear spread horizontal terminals Upper	1SDA073957R1	1SDA073958R1
XT7-XT7 M	SHR-Rear spread horizontal terminals Lower	1SDA073959R1	1SDA073960R1
XT7-XT7 M	FC CuAl 4x4/0 AWG - 500kcmil Upper	1SDA073991R1	1SDA073993R1
XT7-XT7 M	FC CuAl 4x4/0 AWG - 500kcmil Lower	1SDA073992R1	1SDA073994R1

Fixed part adapters

Adapter for mounting the terminals of the fixed circuit-breaker on the fixed part



—
Fixed part adapter

Size	Type	3 poles	4 poles
XT1	XT1 ADP adapter fixed part (2 pieces)	1SDA066305R1	1SDA066306R1
XT2	XT2 ADP adapter fixed part (2 pieces)	1SDA066307R1	1SDA066308R1
XT3	XT3 ADP adapter fixed part (2 pieces)	1SDA066309R1	1SDA066310R1
XT4	XT4 ADP adapter fixed part (2 pieces)	1SDA066311R1	1SDA066312R1
XT5	XT5 400A ADP adapter fixed part (2 pieces)	1SDA104723R1	1SDA104724R1
XT5	XT5 630A ADP adapter fixed part (2 pieces)	1SDA104725R1	1SDA104726R1
XT6	XT6 ADP adapter fixed part (2 pieces)	1SDA104727R1	1SDA104728R1

Note: when using an ADP with the F/EF/MC terminal, also order the "Kit F Front Terminals"

Ordering codes for accessories

Signaling

Auxiliary contacts - AUX

Auxiliary contacts - AUX

Size	Type	Fixed/Plug-in
Uncabled version		
XT1-XT3	AUX 250V AC	1SDA066422R1
XT1-XT3	AUX 24V DC	1SDA066423R1
Cabled version		
XT1	AUX-C 3Q 250V AC Left	1SDA066426R1
XT1-XT3	AUX-C 1Q+1SY 250V	1SDA066431R1
XT1-XT3	AUX-C 2Q+1SY 250V	1SDA066433R1
XT1-XT3	AUX-C 1Q+1SY 24V DC	1SDA066446R1
XT3	AUX-C 3Q+1SY 250V	1SDA066434R1
XT3	AUX-C 3Q+1SY 24V DC	1SDA066448R1
XT3	AUX-C 3Q 250V AC Left	1SDA066428R1



AUX uncabled

Auxiliary contacts - AUX

Size	Type	Fixed/Plug-in	Withdrawable
Uncabled version			
XT2-XT4	AUX 250V AC	1SDA066422R1	
XT2-XT4	AUX-S51 250V AC	1SDA066424R1	
XT2-XT4	AUX 24V DC	1SDA066423R1	
XT2-XT4	AUX-S51 24V DC	1SDA066425R1	
Cabled version			
XT2-XT4	AUX-C 3Q 250V AC Left	1SDA066427R1	
XT2-XT4	AUX-C 1Q+1SY 250V AC	1SDA066431R1	1SDA066432R1
XT2-XT4	AUX-C 2Q+1SY 250V AC	1SDA066433R1	
XT2-XT4	AUX-C 2Q+2SY+1SA 250V AC	1SDA066438R1	1SDA066439R1
XT2-XT4	AUX-C 3Q+1SY 250V AC	1SDA066434R1	1SDA066435R1
XT2-XT4	AUX-C 3Q+2SY 250V AC	1SDA066436R1	1SDA066437R1
XT2-XT4	AUX-S51-C 250V AC	1SDA066429R1	1SDA066430R1
XT2-XT4	AUX-C 1Q+1SY 24V DC	1SDA066446R1	1SDA066447R1
XT2-XT4	AUX-C 3Q+1SY 24V DC	1SDA066448R1	1SDA066449R1
XT2-XT4	AUX-S51-C 24V DC	1SDA067116R1	1SDA067117R1
XT2-XT4	AUX-C 1Q+1SY 400V AC	1SDA066444R1	1SDA066445R1
XT2-XT4	AUX-C 2Q 400V AC	1SDA066440R1	1SDA066443R1



AUX cabled



AUX for withdrawable version

Auxiliary contacts - AUX

Size	Type	Fixed/Plug-in	Withdrawable
Uncabled version			
XT5	AUX 250V AC	1SDA066422R1	
XT5	AUX 24V DC	1SDA066423R1	
Cabled version			
XT5	AUX-C 1Q+1SY 250V AC left	1SDA104787R1	
XT5	AUX-C 1Q+1SY 250V AC	1SDA066431R1	1SDA104789R1
XT5	AUX-C 2Q+1SY 250V AC	1SDA066433R1	1SDA104796R1
XT5	AUX-C 3Q+1SY 250V AC	1SDA066434R1	1SDA104798R1
XT5	AUX-S51-C 250V AC	1SDA066429R1	1SDA104791R1
XT5	AUX-S52-C 250V AC	1SDA104800R1	1SDA104793R1
XT5	AUX-C 1Q+1SY 24V DC left	1SDA104786R1	
XT5	AUX-C 1Q+1SY 24V DC	1SDA066446R1	1SDA104788R1
XT5	AUX-C 3Q+1SY 24V DC	1SDA066448R1	1SDA104797R1
XT5	AUX-S51-C 24V DC	1SDA067116R1	1SDA104790R1
XT5	AUX-S52-C 24V DC	1SDA104799R1	1SDA104792R1
XT5	AUX-C 1Q+1SY 400V AC	1SDA104784R1	1SDA104785R1
XT5	AUX-C 2Q 400V AC	1SDA104795R1	1SDA104794R1

Auxiliary contacts - AUX

Size	Type	Fixed/Plug-in	Withdrawable
Uncabled version			
XT6	AUX 250V AC	1SDA066422R1	
XT6	AUX 24V DC	1SDA066423R1	
Cabled version			
XT6	AUX-C 1Q+1SY 250V AC	1SDA066431R1	1SDA104802R1
XT6	AUX-C 2Q+1SY 250V AC	1SDA066433R1	1SDA104807R1
XT6	AUX-C 3Q+1SY 250V AC	1SDA066434R1	1SDA104809R1
XT6	AUX-S51-C 250V AC	1SDA066429R1	1SDA104804R1
XT6	AUX-S52-C 250V AC	1SDA104800R1	1SDA104806R1
XT6	AUX-C 1Q+1SY 24V DC	1SDA066446R1	1SDA104801R1
XT6	AUX-C 3Q+1SY 24V DC	1SDA066448R1	1SDA104808R1
XT6	AUX-S51-C 24V DC	1SDA067116R1	1SDA104803R1
XT6	AUX-S52-C 24V DC	1SDA104799R1	1SDA104805R1

Ordering codes for accessories

Signaling



Open/close auxiliary contacts - AUX



Terminal for auxiliary connection

Auxiliary contacts - AUX

Size	Type	Fixed/ Withdrawable
XT7-XT7 M	AUX 4Q 400V	1SDA073750R1
XT7-XT7 M	AUX 4Q 24Vdc	1SDA073751R1
XT7-XT7 M	AUX 2Q 400VAC + 2Q 24VDC	1SDA073752R1
XT7-XT7 M	AUX S51 250V	1SDA073776R1
XT7-XT7 M	AUX S51 24V	1SDA073777R1
XT7	AUX 1SY 400V	1SDA104813R1
XT7	AUX 1SY 24V	1SDA104812R1
XT7	AUX 1S52 250V	1SDA104811R1
XT7	AUX 1S52 24V	1SDA104810R1
XT7 M	AUX 15Q 400V	1SDA073758R1
XT7 M	AUX 15Q 24V	1SDA073759R1
XT7 M	RTC 250V	1SDA073770R1
XT7 M	RTC 24V	1SDA073771R1
XT7 M	AUX S33 M/2 250V	1SDA104825R1
XT7 M	AUX S33 M/2 24V	1SDA104824R1

Terminals for auxiliary connection

Size	Type	Code
XT7-XT7 M	Terminals 10 pcs	1SDA073906R1

Auxiliary position contacts - AUP

Auxiliary position contacts -AUP

Size	Type	Code
XT1-XT3	AUP-I – Four racked-in contacts 250V AC	1SDA066450R1
XT1-XT3	AUP-I – Four racked-in contacts 24V DC	1SDA066451R1
XT2-XT4	AUP-I – Four racked-in contacts 250V AC	1SDA066450R1
XT2-XT4	AUP-I – Four racked-in contacts 24V DC	1SDA066451R1
XT2-XT4	AUP-R – Two racked-out contacts 250V AC	1SDA066452R1
XT2-XT4	AUP-R – Two racked-out contacts 24V DC	1SDA066453R1
XT5-XT6	AUP-I – Three Racked-in contacts 250V AC	1SDA104815R1
XT5-XT6	AUP-I – Three Racked-in contacts 24V DC	1SDA104816R1
XT5-XT6	AUP-T – One Test contact 250V AC	1SDA104820R1
XT5-XT6	AUP-T – One Test contact 24V DC	1SDA104819R1
XT5-XT6	AUP-R – One Racked-out contact 250V AC	1SDA104817R1
XT5-XT6	AUP-R – One Racked-out contact 24V DC	1SDA104818R1
XT7-XT7 M	AUP 6 contacts 24V	1SDA073763R1
XT7-XT7 M	AUP 6 contacts 400V	1SDA073762R1



—
Auxiliary position
contact - AUP

Early auxiliary contacts - AUE

Auxiliary contacts - AUX

Size	Type	Fixed/Plug-in	Withdrawable
XT1-XT3	AUE - Two contacts in rotary handle RHx (closed)	1SDA066454R1	
XT1-XT3	AUE - Two contacts in rotary handle RHx (open)	1SDA067118R1	
XT2-XT4	AUE - Two contacts in rotary handle RHx (closed)	1SDA066454R1	1SDA066455R1
XT2-XT4	AUE - Two contacts in rotary handle RHx (open)	1SDA067118R1	1SDA067119R1
XT5-XT6	AUE - Two contacts in rotary handle RHx (closed)	1SDA104821R1	1SDA104822R1
XT7	AUE - Two contacts in circuit-breaker (closed) ⁽¹⁾	1SDA104823R1	1SDA104823R1

(1) Contacts that can work only with a rotary handle



—
Early auxiliary contacts
in the handle - AUE

Ordering codes for accessories

Operating mechanism

Rotary handle operating mechanism

Rotary handles XT1-XT3



Direct rotary handle - RHD



Transmitted rotary handle - RHE

Size	Type	Fixed/Plug-in
XT1-XT3	RHD Normal direct handle	1SDA066475R1
XT1-XT3	RHD Direct emergency handle	1SDA066477R1
XT1-XT3	RHE Normal transmitted handle	1SDA066479R1
XT1-XT3	RHE Emergency transmitted handle	1SDA066481R1
XT1-XT3	RHS-L Normal left lateral handle	1SDA066579R1
XT1-XT3	RHS-L Emergency left lateral handle	1SDA066580R1
XT1-XT3	RHS-R Normal right lateral handle	1SDA066581R1
XT1-XT3	RHS-R Emergency right lateral handle	1SDA066582R1
Spare parts for transmitted handle		
XT1-XT3	RHE_B Base for transmitted Handle	1SDA066483R1
XT1-XT3	RHE_S Rod of 500mm	1SDA066576R1
XT1-XT3	RHE_H Normal transmitted handle	1SDA066577R1
XT1-XT3	RHE_H Emergency transmitted handle	1SDA066578R1
XT1-XT3	LH Normal large handle	1SDA066583R1
XT1-XT3	LH Large emergency handle	1SDA066585R1

Flange Handle XT1

Size	Type	Fixed
XT1	Flange handle kit L=4' NEMA 1, 3, 12, 4	1SDA080334R1
XT1	Flange handle kit L=6' NEMA 1, 3, 12, 4	1SDA080335R1
XT1	Flange handle kit L=10' NEMA 1, 3, 12, 4	1SDA080337R1
XT1	Flange handle kit L=4' NEMA 4X	1SDA082010R1
XT1	Flange handle kit L=6' NEMA 4X	1SDA082011R1
XT1	Flange handle kit L=10' NEMA 4X	1SDA082012R1
Spare parts for flange handle		
XT1	FH_H handle NEMA 1, 3, 12, 4	1SDA080346R1
XT1	FH_H handle NEMA 4X	1SDA082022R1

Flange Handle XT3

Size	Type	Fixed
XT3	Flange handle kit L=4' NEMA 1, 3, 12, 4	1SDA080342R1
XT3	XT4 Flange handle kit L=6' NEMA 1, 3, 12, 4	1SDA080343R1
XT3	XT4 Flange handle kit L=10' NEMA 1, 3, 12, 4	1SDA080345R1
XT3	XT4 Flange handle kit L=4' NEMA 4X	1SDA082016R1
XT3	XT4 Flange handle kit L=6' NEMA 4X	1SDA082017R1
XT3	XT4 Flange handle kit L=10' NEMA 4X	1SDA082018R1
Spare parts for flange handle		
XT3	XT4 FH_H handle NEMA 1, 3, 12, 4	1SDA080346R1
XT3	XT4 FH_H handle NEMA 4X	1SDA082022R1



Large handle - LH



Lateral handle - RHS

Rotary handles XT2-XT4

Size	Type	Fixed/Plug-in	Withdrawable
XT2-XT4	XT2-XT4 RHD Normal direct handle	1SDA069053R1	1SDA066476R1
XT2-XT4	XT2-XT4 RHD Direct emergency handle	1SDA069054R1	1SDA066478R1
XT2-XT4	XT2-XT4 RHE Normal transmitted handle	1SDA069055R1	1SDA066480R1
XT2-XT4	XT2-XT4 RHE Emergency transmitted handle	1SDA069056R1	1SDA066482R1
XT2-XT4	XT2-XT4 RHS-L Normal left lateral handle	1SDA069058R1	
XT2-XT4	XT2-XT4 RHS-L Emergency left lateral handle	1SDA069059R1	
XT2-XT4	XT2-XT4 RHS-R Normal right lateral handle	1SDA069060R1	
XT2-XT4	XT2-XT4 RHS-R Emergency right lateral handle	1SDA069061R1	
Spare parts for transmitted handles			
XT2-XT4	RHE_B Base for transmitted handle	1SDA069057R1	1SDA066484R1
XT2-XT4	RHE_S Rod of 500mm	1SDA066576R1	
XT2-XT4	Telescopic Rod kit	1SDA104869R1	
XT2-XT4	RHE_H Normal transmitted handle	1SDA066577R1	
XT2-XT4	RHE_H Emergency transmitted handle	1SDA066578R1	
XT2-XT4	LH Normal large handle	1SDA066583R1	
XT2-XT4	LH Large emergency handle	1SDA066585R1	

Flange Handle XT2

Size	Type	Fixed
XT2	Flange handle kit L=4' NEMA 1, 3, 12, 4	1SDA080334R1
XT2	Flange handle kit L=6' NEMA 1, 3, 12, 4	1SDA080335R1
XT2	Flange handle kit L=10' NEMA 1, 3, 12, 4	1SDA080337R1
XT2	Flange handle kit L=4' NEMA 4X	1SDA082010R1
XT2	Flange handle kit L=6' NEMA 4X	1SDA082011R1
XT2	Flange handle kit L=10' NEMA 4X	1SDA082012R1
Spare parts for flange handle		
XT2	FH_H handle NEMA 1, 3, 12, 4	1SDA080346R1
XT2	FH_H handle NEMA 4X	1SDA082022R1

Flange Handle XT4

Size	Type	Fixed
XT4	Flange handle kit L=4' NEMA 1, 3, 12, 4	1SDA080342R1
XT4	Flange handle kit L=6' NEMA 1, 3, 12, 4	1SDA080343R1
XT4	Flange handle kit L=10' NEMA 1, 3, 12, 4	1SDA080345R1
XT4	Flange handle kit L=4' NEMA 4X	1SDA082016R1
XT4	Flange handle kit L=6' NEMA 4X	1SDA082017R1
XT4	Flange handle kit L=10' NEMA 4X	1SDA082018R1
Spare parts for flange handle		
XT4	FH_H handle NEMA 1, 3, 12, 4	1SDA080346R1
XT4	FH_H handle NEMA 4X	1SDA082022R1

Ordering codes for accessories

Operating mechanism



Direct rotary handle - RHD



Transmitted rotary handle - RHE



Conversion kit RHE -> RHS

Rotary handles XT5

Size	Type	Fixed/Plug-in	Withdrawable
XT5	RHD Normal direct handle	1SDA104826R1	1SDA104828R1
XT5	RHD Normal direct handle + 2PLL	1SDA104827R1	1SDA104829R1
XT5	RHD Direct emergency handle	1SDA104830R1	1SDA104831R1
XT5	RHE Normal transmitted handle	1SDA104843R1	1SDA104844R1
XT5	RHE Emergency transmitted handle	1SDA104849R1	1SDA104850R1
Spare parts for transmitted handle			
XT5	RHE_B Base for transmitted handle	1SDA104845R1	1SDA104847R1
XT5	RHE_B Base for transmitted handle + 2PLL	1SDA104846R1	1SDA104848R1
XT5	RHE_S Rod of 500mm	1SDA113118R1	
XT5	Telescopic Rod kit	1SDA104869R1	
XT5	RHE_H Normal transmitted handle	1SDA104851R1	
XT5	RHE_H Emergency transmitted handle	1SDA104852R1	
XT5	Conversion kit RHE->RHS	1SDA104870R1	

Rotary handles XT6

Size	Type	Fixed/Plug-in	Withdrawable
XT6	RHD Normal direct handle	1SDA104832R1	1SDA104834R1
XT6	RHD Normal direct handle + 2PLL	1SDA104833R1	1SDA104835R1
XT6	RHD Direct emergency handle	1SDA104836R1	1SDA104837R1
XT6	RHE Normal transmitted handle	1SDA104853R1	1SDA104854R1
XT6	RHE Emergency transmitted handle	1SDA104859R1	1SDA104860R1
Spare parts for transmitted handle			
XT6	RHE_B Base for transmitted handle	1SDA104855R1	1SDA104857R1
XT6	RHE_B Base for transmitted handle + 2PLL	1SDA104856R1	1SDA104858R1
XT6	RHE_S Rod of 500mm	1SDA113118R1	
XT6	Telescopic Rod kit	1SDA104869R1	
XT6	RHE_H Normal transmitted handle	1SDA104867R1	
XT6	RHE_H Emergency transmitted handle	1SDA104868R1	



—
Direct rotary handle
+ 2PLL XT7 - RHD



—
Transmitted rotary
handle + 2PLL XT7 - RHE

Rotary handles XT7

Size	Type	Fixed	Withdrawable
XT7	RHD Normal direct handle	1SDA104838R1	1SDA104838R1
XT7	RHD Normal direct handle + 2PLL	1SDA104839R1	1SDA104839R1
XT7	RHD Direct emergency handle	1SDA104840R1	1SDA104840R1
XT7	RHE Normal transmitted handle	1SDA104863R1	1SDA104863R1
XT7	RHE Emergency transmitted handle	1SDA104866R1	1SDA104866R1
Spare parts for transmitted handle			
XT7	RHE_B Base for transmitted handle	1SDA104864R1	1SDA104864R1
XT7	RHE_B Base for transmitted handle + 2PLL	1SDA104865R1	1SDA104865R1
XT7	RHE_S Rod of 500mm	1SDA064104R1	
XT7	RHE_H Normal transmitted handle	1SDA104867R1	
XT7	RHE_H Emergency transmitted handle	1SDA104868R1	

Toggle Extension

Size	Type	Fixed/Plug-in	Withdrawable
XT5...XT7	Toggle extension XT5-XT6-XT7	1SDA104875R1	

Front for operating lever mechanism - FLD

Front for operating lever mechanism - FLD



—
Front for operating
lever mechanism - FLD

Size	Type	Fixed/Plug-in	Withdrawable
XT2-XT4	Front for locks - FLD	1SDA066635R1	1SDA066636R1
XT5	Front for locks - FLD	1SDA104871R1	1SDA104872R1
XT6	Front for locks - FLD	1SDA104873R1	1SDA104874R1

Ordering codes for accessories

Remote control

Shunt Opening Release

Shunt opening release - SOR



SOR uncabled

Size	Type	Fixed/Plug-in	Withdrawable
Uncabled version			
XT1...XT4	SOR 12V DC	1SDA066313R1	
XT1...XT4	SOR 24-30V AC/DC	1SDA066314R1	
XT1...XT4	SOR 48-60V AC/DC	1SDA066315R1	
XT1...XT4	SOR 110...127V AC / 110...125V DC	1SDA066316R1	
XT1...XT4	SOR 220...240V AC / 220...250V DC	1SDA066317R1	
XT1...XT4	SOR 380-440V AC	1SDA066318R1	
XT1...XT4	SOR 480-525V AC	1SDA066319R1	
Cabled version			
XT1-XT3	SOR-C 12V DC	1SDA066321R1	
XT1-XT3	SOR-C 24-30V AC/DC	1SDA066322R1	
XT1-XT3	SOR-C 48-60V AC/DC	1SDA066323R1	
XT1-XT3	SOR-C 110-127V AC / 110-125V DC	1SDA066324R1	
XT1-XT3	SOR-C 220-240V AC / 220-250V DC	1SDA066325R1	
XT1-XT3	SOR-C 380-440V AC	1SDA066326R1	
XT1-XT3	SOR-C 480-525V AC	1SDA066327R1	
XT2-XT4	SOR-C 12V DC	1SDA066321R1	1SDA066328R1
XT2-XT4	SOR-C 24-30V AC/DC	1SDA066322R1	1SDA066329R1
XT2-XT4	SOR-C 48-60V AC/DC	1SDA066323R1	1SDA066330R1
XT2-XT4	SOR-C 110-127V AC / 110-125V DC	1SDA066324R1	1SDA066331R1
XT2-XT4	SOR-C 220-240V AC / 220-250V DC	1SDA066325R1	1SDA066332R1
XT2-XT4	SOR-C 380-440V AC	1SDA066326R1	1SDA066333R1
XT2-XT4	SOR-C 480-525V AC	1SDA066327R1	1SDA066334R1



SOR cabled



SOR for withdrawable version

Shunt opening release -YO

Size	Type	Fixed/Plug-in	Withdrawable
Uncabled version			
XT5-XT6	YO 12V DC	1SDA104924R1	
XT5-XT6	YO 24...60V AC/DC	1SDA104925R1	
XT5-XT6	YO 110..240V AC - 110..250V DC	1SDA104926R1	
XT5-XT6	YO 380...440V AC		
XT5-XT6	YO 440...525V AC		
Cabled version			
XT5	YO 12V DC	1SDA104932R1	1SDA104928R1
XT5	YO 24...60V AC/DC	1SDA104933R1	1SDA104929R1
XT5	YO 110..240V AC - 110..250V DC	1SDA104934R1	1SDA104930R1
XT5	YO 380...440V AC		
XT5	YO 440...525V AC		
XT6	YO 12V DC	1SDA104932R1	1SDA104936R1
XT6	YO 24...60V AC/DC	1SDA104933R1	1SDA104937R1
XT6	YO 110..240 Vac - 110..250V DC	1SDA104934R1	1SDA104938R1
XT6	YO 380...440V AC		
XT6	YO 440...525V AC		



YO uncabled



— Shunt opening release - YO

Shunt opening release -YO

Size	Type	Code
XT7-XT7 M	YO 24V AC/DC	1SDA073668R1
XT7-XT7 M	YO 30V AC/DC	1SDA073669R1
XT7-XT7 M	YO 48V AC/DC	1SDA073670R1
XT7-XT7 M	YO 60V AC/DC	1SDA073671R1
XT7-XT7 M	YO 110-120V AC/DC	1SDA073672R1
XT7-XT7 M	YO 120-127V AC/DC	1SDA073673R1
XT7-XT7 M	YO 220-240V AC/DC	1SDA073674R1
XT7-XT7 M	YO 240-250V AC/DC	1SDA073675R1
XT7-XT7 M	YO 380-400V AC	1SDA073677R1
XT7-XT7 M	YO 415-440V AC	1SDA073678R1
XT7-XT7 M	YO 480-500V AC	1SDA073679R1

Undervoltage release



— UVR uncabled

Undervoltage release - UVR

Size	Type	Fixed/Plug-in	Withdrawable
Uncabled version			
XT1...XT4	UVR 24-30V AC/DC	1SDA066389R1	
XT1...XT4	UVR 48V AC/DC	1SDA069064R1	
XT1...XT4	UVR 60V AC/DC	1SDA066390R1	
XT1...XT4	UVR 110...127V AC / 110...125V DC	1SDA066391R1	
XT1...XT4	UVR 220...240V AC / 220...250V DC	1SDA066392R1	
XT1...XT4	UVR 380-440V AC	1SDA066393R1	
XT1...XT4	UVR 480-525V AC	1SDA066394R1	
Cabled version			
XT1-XT3	UVR-C 24-30V AC/DC	1SDA066396R1	
XT1-XT3	UVR 48V AC/DC	1SDA069065R1	
XT1-XT3	UVR 60V AC/DC	1SDA066397R1	
XT1-XT3	UVR 110...127V AC / 110...125V DC	1SDA066398R1	
XT1-XT3	UVR 220...240V AC / 220...250V DC	1SDA066399R1	
XT1-XT3	UVR 380-440V AC	1SDA066400R1	
XT1-XT3	UVR 480-525V AC	1SDA066401R1	
XT2-XT4	UVR-C 24-30V AC/DC	1SDA066396R1	1SDA066403R1
XT2-XT4	UVR 48V AC/DC	1SDA069065R1	1SDA069066R1
XT2-XT4	UVR 60V AC/DC	1SDA066397R1	1SDA066404R1
XT2-XT4	UVR 110...127V AC / 110...125V DC	1SDA066398R1	1SDA066405R1
XT2-XT4	UVR 220...240V AC / 220...250V DC	1SDA066399R1	1SDA066406R1
XT2-XT4	UVR 380-440V AC	1SDA066400R1	1SDA066407R1
XT2-XT4	UVR 480-525V AC	1SDA066401R1	1SDA066408R1



— UVR cabled



— UVR for withdrawable

Ordering codes for accessories

Remote control



—
YU uncabled

Undervoltage release -YU

Size	Type	Fixed/Plug-in	Withdrawable
Uncabled version			
XT5-XT6	YU 12V DC	1SDA104940R1	
XT5-XT6	YU 24...30V AC/DC	1SDA104941R1	
XT5-XT6	YU 48...60V AC/DC	1SDA104942R1	
XT5-XT6	YU 110..127V AC - 110..125V DC	1SDA104943R1	
XT5-XT6	YU 220..240V AC - 220..250V DC	1SDA104944R1	
XT5-XT6	YU 380...440V AC	1SDA104945R1	
XT5-XT6	YU 480...525V AC	1SDA104946R1	
Cabled version			
XT5	YU-C 12V DC	1SDA104954R1	1SDA104947R1
XT5	YU-C 24...30V AC/DC	1SDA104955R1	1SDA104948R1
XT5	YU-C 48...60V AC/DC	1SDA104956R1	1SDA104949R1
XT5	YU-C 110..127V AC - 110..125V DC	1SDA104957R1	1SDA104950R1
XT5	YU-C 220..240V AC - 220..250V DC	1SDA104958R1	1SDA104951R1
XT5	YU-C 380...440V AC	1SDA104959R1	1SDA104952R1
XT5	YU-C 480...525V AC	1SDA104960R1	1SDA104953R1
XT6	YU-C 12V DC	1SDA104954R1	1SDA104961R1
XT6	YU-C 24...30V AC/DC	1SDA104955R1	1SDA104962R1
XT6	YU-C 48...60V AC/DC	1SDA104956R1	1SDA104963R1
XT6	YU-C 110..127V AC - 110..125V DC	1SDA104957R1	1SDA104964R1
XT6	YU-C 220..240V AC - 220..250V DC	1SDA104958R1	1SDA104965R1
XT6	YU-C 380...440V AC	1SDA104959R1	1SDA104966R1
XT6	YU-C 480...525V AC	1SDA104960R1	1SDA104967R1

Undervoltage release -YU

Size	Type	Code
XT7-XT7 M	YU 24V AC/DC	1SDA073694R1
XT7-XT7 M	YU 30V AC/DC	1SDA073695R1
XT7-XT7 M	YU 48V AC/DC	1SDA073696R1
XT7-XT7 M	YU 60V AC/DC	1SDA073697R1
XT7-XT7 M	YU 110-120V AC/DC	1SDA073698R1
XT7-XT7 M	YU 120-127V AC/DC	1SDA073699R1
XT7-XT7 M	YU 220-240V AC/DC	1SDA073700R1
XT7-XT7 M	YU 240-250V AC/DC	1SDA073701R1
XT7-XT7 M	YU 380-400V AC	1SDA073703R1
XT7-XT7 M	YU 415-440V AC	1SDA073704R1
XT7-XT7 M	YU 480-500V AC	1SDA073705R1



—
Undervoltage
release - YU



Closing release - YC

Closing release -YC

Size	Type	Code
XT7-XT7 M	YC 24V AC/DC	1SDA073681R1
XT7-XT7 M	YC 30V AC/DC	1SDA073682R1
XT7-XT7 M	YC 48V AC/DC	1SDA073683R1
XT7-XT7 M	YC 60V AC/DC	1SDA073684R1
XT7-XT7 M	YC 110-120V AC/DC	1SDA073685R1
XT7-XT7 M	YC 120-127V AC/DC	1SDA073686R1
XT7-XT7 M	YC 220-240V AC/DC	1SDA073687R1
XT7-XT7 M	YC 240-250V AC/DC	1SDA073688R1
XT7-XT7 M	YC 380-400V AC	1SDA073690R1
XT7-XT7 M	YC 415-440V AC	1SDA073691R1
XT7-XT7 M	YC 480-500V AC	1SDA073692R1

Shunt opening test unit**SOR/YO test unit**

Size	Type	Code
XT1...XT7M	YO/YC test unit	1SDA082751R1

Delay device for undervoltage release - UVD**Delay device for undervoltage release -UVD**

Time delay device for undervoltage release - UVD

Size	Type	Code
XT1...XT4	UVD 24...30V AC/DC	1SDA051357R1
XT1...XT4	UVD 48...60V AC/DC	1SDA051358R1
XT1...XT4	UVD 110...125V AC/DC	1SDA051360R1
XT1...XT4	UVD 220...250V AC/DC	1SDA051361R1
XT5-XT6	UVD 24..30V	1SDA101983R1
XT5-XT6	UVD 48..60V	1SDA101984R1
XT5-XT6	UVD 110..125V	1SDA101981R1
XT5-XT6	UVD 220..250V	1SDA101982R1
XT7 - XT7 M	UVD 24/30V	1SDA038316R1
XT7 - XT7 M	UVD 48V	1SDA038317R1
XT7 - XT7 M	UVD 60V	1SDA038318R1
XT7 - XT7 M	UVD 110/127V	1SDA038319R1
XT7 - XT7 M	UVD 220/250V	1SDA038320R1

Connectors for shunt opening and undervoltage release for withdrawable version**Connectors for shunt opening and undervoltage release for withdrawable version**

Fixed/Moving part connector for withdrawable

Size	Type	Code
Connector of 4th pole for withdrawable version		
XT2-XT4	Connector 4th pole SOR	1SDA066415R1
XT2-XT4	Connector 4th pole UVR	1SDA066418R1
Connector of 3rd pole for withdrawable version		
XT5	Connector 3rd pole YO	1SDA104968R1
XT5	Connector 3rd pole YU	1SDA104970R1

Ordering codes for accessories

Remote control



Remote reset - YR

Remote reset - YR

Remote reset - YR

Size	Type	Code
XT7 M	YR 24V DC	1SDA073744R1
XT7 M	YR 110V AC/DC	1SDA073745R1
XT7 M	YR 220V AC/DC	1SDA073746R1

Motor operator

Direct action motor operator - MOD

Size	Type	Code
XT1-XT3	MOD 24V DC	1SDA066457R1
XT1-XT3	MOD 48...60V DC	1SDA066458R1
XT1-XT3	MOD 110...125V AC/DC	1SDA066459R1
XT1-XT3	MOD 220...250V AC/DC	1SDA066460R1
XT1-XT3	MOD 380...440V AC	1SDA066461R1
XT1-XT3	MOD 480...525V AC	1SDA066462R1



Motor operator - MOD

Stored energy motor operator - MOE

Size	Type	Code
XT2-XT4	XT2-XT4 MOE 24V DC	1SDA066463R1
XT2-XT4	XT2-XT4 MOE 48...60V DC	1SDA066464R1
XT2-XT4	XT2-XT4 MOE 110...125V AC/DC	1SDA066465R1
XT2-XT4	XT2-XT4 MOE 220...250V AC/DC	1SDA066466R1
XT2-XT4	XT2-XT4 MOE 380...440V AC	1SDA066467R1
XT2-XT4	XT2-XT4 MOE 480...525V AC	1SDA066468R1
XT5	XT5 MOE 24V DC	1SDA104879R1
XT5	XT5 MOE 48...60V DC	1SDA104881R1
XT5	XT5 MOE 110...125V AC/DC	1SDA104883R1
XT5	XT5 MOE 220...250V AC/DC	1SDA104885R1
XT5	XT5 MOE 380V AC	1SDA104887R1
XT6	XT6 MOE 24V DC	1SDA104889R1
XT6	XT6 MOE 48...60V DC	1SDA104891R1
XT6	XT6 MOE 110...125V AC/DC	1SDA104893R1
XT6	XT6 MOE 220...250V AC/DC	1SDA104895R1
XT6	XT6 MOE 380V AC	1SDA104897R1



Motor operator - MOE



Motor operator - MOE

Electronic stored energy motor operator - MOE-E

Size	Type	Code
XT2-XT4	XT2-XT4 MOE-E 24V DC	1SDA066469R1
XT2-XT4	XT2-XT4 MOE-E 48...60V DC	1SDA066470R1
XT2-XT4	XT2-XT4 MOE-E 110...125V AC/DC	1SDA066471R1
XT2-XT4	XT2-XT4 MOE-E 220...250V AC/DC	1SDA066472R1
XT2-XT4	XT2-XT4 MOE-E 380...440V AC	1SDA066473R1
XT2-XT4	XT2-XT4 MOE-E 480...525V AC	1SDA066474R1
XT5	XT5 MOE-E 24V DC	1SDA104899R1
XT5	XT5 MOE-E 48...60V DC	1SDA104901R1
XT5	XT5 MOE-E 110...125V AC/DC	1SDA104903R1
XT5	XT5 MOE-E 220...250V AC/DC	1SDA104905R1
XT5	XT5 MOE-E 380V AC	1SDA104907R1

Spring charging motor - M

Spring charging motor - M

Size	Type	Code
XT7 M	M 24-30 V AC/DC	1SDA104919R1
XT7 M	M 48-60 V AC/DC	1SDA104920R1
XT7 M	M 100-130 V AC/DC	1SDA104921R1
XT7 M	M 220-250 V AC/DC	1SDA104922R1
XT7 M	M 380-415 V AC/DC	1SDA104923R1

Ordering codes for accessories

Safety and protection

Terminals covers and phase separators



Terminal cover

Insulating terminal covers

Size	Type	3 poles	4 poles
XT1	LTC Low terminal covers	1SDA066655R1	1SDA066656R1
XT1	HTC High terminal covers	1SDA066664R1	1SDA066665R1
XT2	LTC Low terminal covers	1SDA066657R1	1SDA066659R1
XT2	HTC High terminal covers	1SDA066666R1	1SDA066667R1
XT3	LTC Low terminal covers	1SDA066660R1	1SDA066661R1
XT3	HTC High terminal covers	1SDA066668R1	1SDA066669R1
XT4	LTC Low terminal covers	1SDA066662R1	1SDA066663R1
XT4	HTC High terminal covers	1SDA066670R1	1SDA066671R1
XT5	LTC Low terminal covers	1SDA105018R1	1SDA105019R1
XT5	HTC High terminal covers	1SDA105025R1	1SDA105026R1
XT5	HTC_BS High terminal covers with back shield	1SDA105043R1	1SDA105044R1
XT5	HTC_ES High terminal covers for ES	1SDA105031R1	1SDA105032R1
XT5	HTC_ES_BS High terminal covers for ES with back shield	1SDA105037R1	1SDA105038R1
XT5	HTC - XT5 FP RC 4p		1SDA105024R1
XT6	LTC Low terminal covers	1SDA105020R1	1SDA105021R1
XT6	HTC High terminal covers	1SDA105027R1	1SDA105028R1
XT6	HTC_BS High terminal covers with back shield	1SDA105045R1	1SDA105046R1
XT6	HTC_ES High terminal covers for ES	1SDA105033R1	1SDA105034R1
XT6	HTC_ES_BS High terminal covers for ES with back shield	1SDA105039R1	1SDA105040R1
XT7-XT7 M	LTC Low terminal covers	1SDA107475R1	1SDA107476R1
XT7-XT7 M	LTC Low terminal covers for W	1SDA105022R1	1SDA105023R1
XT7-XT7 M	HTC High terminal covers	1SDA105029R1	1SDA105030R1
XT7-XT7 M	HTC_BS High terminal covers with back shield	1SDA105047R1	1SDA105048R1
XT7-XT7 M	HTC_ES High terminal covers for ES	1SDA105035R1	1SDA105036R1
XT7-XT7 M	HTC_ES_BS High terminal covers for ES with back shield	1SDA105041R1	1SDA105042R1

Insulating plates

Size	Type	3 poles	4 poles
XT5	Terminal insulating plate XT5 fixed	1SDA112971R1	1SDA112972R1

Sealable screws for terminal covers

Size	Type	Code
XT1...XT4	Kit with two sealable screws	1SDA066672R1



Sealable screw



Phase separators for circuit-breaker

Size	Type	4 pcs	6 pcs
XT1-XT3	PB Height 25mm	1SDA066674R1	1SDA066679R1
XT1-XT3	PB Height 100mm	1SDA066676R1	1SDA066681R1
XT1-XT3	PB Height 200mm	1SDA066678R1	1SDA066683R1
XT2-XT4	PB Height 25mm	1SDA069062R1	1SDA069063R1
XT2-XT4	PB Height 100mm	1SDA066675R1	1SDA066680R1
XT2-XT4	PB Height 200mm	1SDA066677R1	1SDA066682R1
XT5	PB Height 25mm	1SDA105006R1	1SDA105007R1
XT5	PB Height 100mm	1SDA105002R1	1SDA105003R1
XT5	PB Height 200mm	1SDA105004R1	1SDA105005R1
XT6	PB Height 100mm	1SDA105010R1	1SDA105011R1
XT6	PB Height 200mm	1SDA105012R1	1SDA105013R1
XT7-XT7 M	PB Height 100mm	1SDA073877R1	1SDA073878R1
XT7-XT7 M	PB Height 200mm	1SDA073879R1	1SDA073880R1

Phase separators for fixed parts

Size	Type	4 pcs	6 pcs
XT1	PS - Rear phase separators for FP	1SDA068953R1	1SDA068954R1
XT2	PS - Rear phase separators for FP	1SDA068953R1	1SDA068954R1
XT3	PS - Rear phase separators for FP	1SDA068953R1	1SDA068954R1
XT4	PS - Rear phase separators for FP	1SDA068953R1	1SDA068954R1
XT5	PS - Rear phase separators for FP	1SDA105008R1	1SDA105009R1
Size	Type	2 pcs	3 pcs
XT7-XT7M	PS - Phase separators for FP W	1SDA076164R1	1SDA076165R1

Ordering codes for accessories

Safety and protection

IP Protection

IP Protection for rotary handles



IP54 protection for RHE

Size	Type	Code
XT1...XT4	IP54 protection for RHE	1SDA066587R1
XT5	IP54 protection for RHD	1SDA104876R1
XT6	IP54 protection for RHD	1SDA104877R1
XT7	IP54 protection for RHD	1SDA104878R1

IP Protection for motor operators



IP54 protection for XT7 M

Size	Type	Code
XT5	IP54 Flange with different keys for MOE	1SDA105105R1
XT5	IP54 Flange with the same keys for MOE	1SDA105106R1
XT6	IP54 Flange with different keys for MOE	1SDA105107R1
XT6	IP54 Flange with the same keys for MOE	1SDA105108R1
XT7 M	IP54 Flange with different keys	1SDA073866R1
XT7 M	IP54 Flange with the same keys	1SDA073868R1

MOC

Mechanical operation counter - MOC



Mechanical operation counter - MOC

Size	Type	Code
XT7 M	Mechanical operation counter	1SDA101969R1

Keylocks and padlocks

Keylock/padlock for fixed part of withdrawable



—
Keylock/padlock
for fixed part



—
Key lock in racked-in/
test/racked-out
position - KLP



—
Padlock in racked-in/
test/racked-out
position - PLP

Size	Type	Code
XT2-XT4	KL-D Keylock FP, Giussani different keys	1SDA066293R1
XT2-XT4	KL-S Keylock FP, Giussani same keys N.20005	1SDA066294R1
XT2-XT4	KL-D Keylock FP, Ronis 1228 different keys	1SDA066298R1
XT2-XT4	KL-S Keylock FP, Ronis 1228 same keys Type A keys	1SDA066300R1
XT5-XT6	KL-D Keylock FP, Giussani different keys	1SDA105112R1
XT5-XT6	KL-S Keylock FP, Giussani same keys N.20005	1SDA105113R1
XT5-XT6	KL-D Keylock FP, Ronis 1228 different keys	1SDA105109R1
XT5-XT6	KL-S Keylock FP, Ronis 1228 same keys Type A keys	1SDA105114R1
XT5-XT6	KL_A Ronis Arrangement 1104 FP	1SDA105110R1
XT5-XT6	KL_A STI Arrangement FP	1SDA105111R1
XT7-XT7 M	KLP-A Bl. Racked in/out Castell XT7-XT7 M 1st key	1SDA073836R1
XT7-XT7 M	KLP-A Bl. Racked in/out Castell XT7-XT7 M 2nd key	1SDA073837R1
XT7-XT7 M	KLP-A Bl. Racked in/out RonProf Kirk XT7-XT7 M 1st key	1SDA073834R1
XT7-XT7 M	KLP-A Bl. Racked in/out RonProf Kirk XT7-XT7 M 2nd key	1SDA073835R1
XT7-XT7 M	KLP-A Pos.lock Ronis-STI 1key	1SDA085737R1
XT7-XT7 M	KLP-A Pos.lock Ronis-STI 2key	1SDA085738R1
XT7-XT7 M	KLP-D Bl. Racked in/out XT7-XT7 M 1st key	1SDA073822R1
XT7-XT7 M	KLP-D Bl. Racked in/out XT7-XT7 M 2nd key	1SDA073828R1
XT7-XT7 M	KLP-S Bl. Racked in/out N.20005 XT7-XT7 M 1st key	1SDA073823R1
XT7-XT7 M	KLP-S Bl. Racked in/out N.20005 XT7-XT7 M 2nd key	1SDA073829R1
XT7-XT7 M	KLP-S Bl. Racked in/out N.20006 XT7-XT7 M 1st key	1SDA073824R1
XT7-XT7 M	KLP-S Bl. Racked in/out N.20006 XT7-XT7 M 2nd key	1SDA073830R1
XT7-XT7 M	KLP-S Bl. Racked in/out N.20007 XT7-XT7 M 1st key	1SDA073825R1
XT7-XT7 M	KLP-S Bl. Racked in/out N.20007 XT7-XT7 M 2nd key	1SDA073831R1
XT7-XT7 M	KLP-S Bl. Racked in/out N.20008 XT7-XT7 M 1st key	1SDA073826R1
XT7-XT7 M	KLP-S Bl. Racked in/out N.20008 XT7-XT7 M 2nd key	1SDA073832R1
XT7-XT7 M	KLP-S Bl. Racked in/out N.20009 XT7-XT7 M 1st key	1SDA073827R1
XT7-XT7 M	KLP-S Bl. Racked in/out N.20009 XT7-XT7 M 2nd key	1SDA073833R1
XT7-XT7 M	Suppl. locks in racked-out XT7-XT7 M	1SDA073838R1
XT7-XT7 M	PLP Bl. padlocks Racked in/out D=4/6/8mm	1SDA073840R1

Ordering codes for accessories

Safety and protection



Fixed padlock in the open position - PLL



Padlock in the open position - PLC



Removable padlock in the open position

Circuit-breaker padlock

Size	Type	Code
XT1-XT3	PLL Removable lock with padlocks in open position	1SDA066588R1
XT1-XT3	PLL Fixed lock with padlocks in open position	1SDA066589R1
XT1-XT3	PLL Fixed lock with padlocks in open/closed position	1SDA066591R1
XT2-XT4	PLL Fixed lock with padlocks in open position	1SDA066590R1
XT2-XT4	PLL Fixed lock with padlocks in open/closed position	1SDA066592R1
XT5	PLL Removable lock with padlocks in open position	1SDA105100R1
XT5	PLL Fixed lock with padlocks in open position	1SDA105099R1
XT5	PLL Fixed lock with padlocks in open/closed position	1SDA105098R1
XT6	Removable lock with padlocks in open position	1SDA105103R1
XT6	PLL Fixed lock with padlocks in open position	1SDA105102R1
XT6	PLL Fixed lock with padlocks in open/closed position	1SDA105101R1
XT7	PLL Fixed lock with padlocks in open position	1SDA105104R1
XT7 M	PLC Padlocks in open position D=4mm	1SDA073800R1
XT7 M	PLC Padlocks in open position D=7mm	1SDA073801R1
XT7 M	PLC Padlocks in open position D=8mm	1SDA073802R1

Keylock for circuit-breaker - KLC

Size	Type	Code
XT1	KLC Ronis key lock open, different keys, removable in open position	1SDA066593R1
XT1	KLC Ronis key lock open, same Type A keys, removable in open position	1SDA066594R1
XT1	KLC Ronis key lock open, same Type B keys, removable in open position	1SDA066595R1
XT1	KLC Ronis key lock open, same Type C keys, removable in open position	1SDA066596R1
XT1	KLC Ronis key lock open, same Type D keys, removable in open position	1SDA066597R1
XT1	KLC Ronis key lock open, same keys, removable in both position	1SDA066598R1
XT3	KLC Ronis key lock open, different keys, removable in open position	1SDA066605R1
XT3	KLC Ronis key lock open, same Type A keys, removable in open position	1SDA066606R1
XT3	KLC Ronis key lock open, same Type B keys, removable in open position	1SDA066607R1
XT3	KLC Ronis key lock open, same Type C keys, removable in open position	1SDA066608R1
XT3	KLC Ronis key lock open, same Type D keys, removable in open position	1SDA066609R1
XT3	KLC Ronis key lock open, same keys, removable in both position	1SDA066610R1



Key lock on the circuit-breaker



—
Keylock on the
circuit-breaker

Keylock for circuit-breaker - KLC

Size	Type	Code
XT2-XT4	KLC Ronis key lock open, different keys, removable in open position	1SDA066599R1
XT2-XT4	KLC Ronis key lock open, same Type A keys, removable in open position	1SDA066600R1
XT2-XT4	KLC Ronis key lock open, same Type B keys, removable in open position	1SDA066601R1
XT2-XT4	KLC Ronis key lock open, same Type C keys, removable in open position	1SDA066602R1
XT2-XT4	KLC Ronis key lock open, same Type D keys, removable in open position	1SDA066603R1
XT2-XT4	KLC Ronis key lock open, same keys, removable in both position	1SDA066604R1
XT5-XT6	KLC Ronis key lock open, different keys, removable in open position	1SDA105066R1
XT5-XT6	KLC Ronis key lock open, same Type A keys, removable in open position	1SDA105062R1
XT5-XT6	KLC Ronis key lock open, same Type B keys, removable in open position	1SDA105063R1
XT5-XT6	KLC Ronis key lock open, same Type C keys, removable in open position	1SDA105064R1
XT5-XT6	KLC Ronis key lock open, same Type D keys, removable in open position	1SDA105065R1
XT5-XT6	KLC Ronis key lock open, same keys, removable in both position	1SDA105061R1
XT5-XT6	KLC-A Kirk key lock	1SDA105067R1
XT5-XT6	KLC-A Ronis 1104 key lock	1SDA105068R1
XT5-XT6	KLC-A STI key lock	1SDA105069R1
XT7	KLC Ronis key lock open, different keys, removable in open position	1SDA105075R1
XT7	KLC Ronis key lock open, same Type A keys, removable in open position	1SDA105071R1
XT7	KLC Ronis key lock open, same Type B keys, removable in open position	1SDA105072R1
XT7	KLC Ronis key lock open, same Type C keys, removable in open position	1SDA105073R1
XT7	KLC Ronis key lock open, same Type D keys, removable in open position	1SDA105074R1
XT7	KLC Ronis key lock open, same keys, removable in both position	1SDA105070R1
XT7	KLC-A Kirk key lock	1SDA105076R1
XT7	KLC-A Ronis 1104 key lock	1SDA105077R1
XT7	KLC-A STI key lock	1SDA105078R1
XT7	KLC-A Castell key lock	1SDA105149R1
XT7 M	KLC-D Key lock open	1SDA107494R1
XT7 M	KLC-S Key lock open N.20005	1SDA107495R1
XT7 M	KLC-S Key lock open N.20006	1SDA107496R1
XT7 M	KLC-S Key lock open N.20007	1SDA107497R1
XT7 M	KLC-S Key lock open N.20008	1SDA107498R1
XT7 M	KLC-S Key lock open N.20009	1SDA107499R1
XT7 M	KLC-A Castell key lock open ⁽¹⁾	1SDA107500R1
XT7 M	KLC-A Kirk key lock open	1SDA101967R1
XT7 M	KLC-A Ronis 1104 - STI key lock open	1SDA101968R1



—
Key lock in open
position - KLC

(1) Arrangement factory mounted only

Ordering codes for accessories

Safety and protection



Key lock on the handle

Keylock for the RH / FLD

Size	Type	Code
XT1...XT4	RHL Ronis key lock open, different keys – RHx/FLD	1SDA066617R1
XT1...XT4	RHL Ronis key lock open, same Type A keys – RHx/FLD	1SDA066618R1
XT1...XT4	RHL Ronis key lock open, same Type B keys - RHx/FLD	1SDA066619R1
XT1...XT4	RHL Ronis key lock open, same Type C keys - RHx/FLD	1SDA066620R1
XT1...XT4	RHL Ronis key lock open, same Type D keys - RHx/FLD	1SDA066621R1
XT1...XT4	RHL Ronis key lock open/closed, different keys - RHx	1SDA066622R1
XT1...XT4	RHL Ronis key lock open/closed, different keys - FLD	1SDA069182R1
XT5	RHL Ronis key lock open, different keys – RHx/FLD	1SDA105081R1
XT5	RHL Ronis key lock open, same Type A keys – RHx/FLD	1SDA105082R1
XT5	RHL Ronis key lock open, same Type B keys - RHx/FLD	1SDA105083R1
XT5	RHL Ronis key lock open, same Type C keys - RHx/FLD	1SDA105084R1
XT5	RHL Ronis key lock open, same Type D keys - RHx/FLD	1SDA105085R1
XT5	RHL Ronis key lock open/closed, different keys – RHx/FLD	1SDA105080R1
XT6	RHL Ronis key lock open, different keys – FLD	1SDA105091R1
XT6	RHL Ronis key lock open, same Type A keys – FLD	1SDA105086R1
XT6	RHL Ronis key lock open, same Type B keys - FLD	1SDA105087R1
XT6	RHL Ronis key lock open, same Type C keys - FLD	1SDA105088R1
XT6	RHL Ronis key lock open, same Type D keys - FLD	1SDA105089R1
XT6	RHL Ronis key lock open/closed, different keys – FLD	1SDA105090R1
XT6 - XT7	RHL Ronis key lock open, different keys – RHx	1SDA105091R1
XT6 - XT7	RHL Ronis key lock open, same Type A keys – RHx	1SDA105086R1
XT6 - XT7	RHL Ronis key lock open, same Type B keys - RHx	1SDA105087R1
XT6 - XT7	RHL Ronis key lock open, same Type C keys - RHx	1SDA105088R1
XT6 - XT7	RHL Ronis key lock open, same Type D keys - RHx	1SDA105089R1
XT6 - XT7	RHL Ronis key lock open/closed, different keys – RHx	1SDA105090R1

Keylock on the panel door with RHE

Size	Type	Code
XT4...XT7	RHL Ronis key lock open, different keys on the panel door	1SDA105079R1



Key lock on the motor

Keylock on the motor

Size	Type	Code
XT1-XT3	MOL-D Ronis key lock open, different keys	1SDA066623R1
XT1-XT3	MOL-S Ronis key lock open, same Type A keys	1SDA066624R1
XT1-XT3	MOL-S Ronis key lock open, same Type B keys	1SDA066625R1
XT1-XT3	MOL-S Ronis key lock open, same Type C keys	1SDA066626R1
XT1-XT3	MOL-S Ronis key lock open, same Type D keys	1SDA066627R1
XT2-XT4	MOL-D Ronis key lock open, different keys	1SDA066629R1
XT2-XT4	MOL-S Ronis key lock open, same Type A keys	1SDA066630R1
XT2-XT4	MOL-S Ronis key lock open, same Type B keys	1SDA066631R1
XT2-XT4	MOL-S Ronis key lock open, same Type C keys	1SDA066632R1
XT2-XT4	MOL-S Ronis key lock open, same Type D keys	1SDA066633R1
XT2-XT4	MOL-M Key lock against manual operation	1SDA066634R1
XT5-XT6	MOL-D KE.LO. RONIS SEV.1228xMOE	1SDA105092R1
XT5-XT6	MOL-M KEY LOCK RONIS SEV. x MOE	1SDA105093R1
XT5-XT6	MOL-S KE.LO. RONIS EQ.A 1228xMOE	1SDA105094R1
XT5-XT6	MOL-S KE.LO. RONIS EQ.B 1228xMOE	1SDA105095R1
XT5-XT6	MOL-S KE.LO. RONIS EQ.C 1228xMOE	1SDA105096R1
XT5-XT6	MOL-S KE.LO. RONIS EQ.D 1228xMOE	1SDA105097R1

Sealable lock on thermal setting

Size	Type	Code
XT1-XT3	Lock on thermal setting for TMD trip unit	1SDA066651R1

Protection device for opening and closing pushbuttons - PBC

Protection device for opening and closing pushbuttons - PBC

Size	Type	Code
XT7 M	PBC Prot. Pushbuttons AP/CH	1SDA073854R1
XT7 M	PBC Prot. Pushbuttons AP/CH D=4mm	1SDA073857R1
XT7 M	PBC Prot. Pushbuttons AP/CH D=7mm	1SDA073856R1
XT7 M	PBC Prot. Pushbuttons AP/CH D=8mm	1SDA073855R1

Lock to prevent door opening when the circuit-breaker is in the closed position - DLC

Lock to prevent door opening when the circuit-breaker is in the closed position - DLC

Size	Type	Code
XT7-XT7 M	DLC interlock direct door for fixed to wall	1SDA079779R1
XT7-XT7 M	DLC interlock direct door for fixed to floor	1SDA079780R1
XT7-XT7 M	DLC interlock direct door for fixed part withdrawable	1SDA079781R1
XT7-XT7 M	DLC interlock cable door for fixed to wall	1SDA081032R1
XT7-XT7 M	DLC interlock cable door for fixed to floor	1SDA081033R1
XT7-XT7 M	DLC interlock cable door for fixed part withdrawable	1SDA081034R1

Ordering codes for accessories

Safety and protection

Flanges

Flanges for circuit breakers and frontal accessories



—
Flange for circuit-breaker



—
Flange for circuit-breaker for the withdrawable version



—
Flange for circuit-breaker

Size	Type	3 poles	4 poles
XT1	Small flange for circuit-breaker	1SDA068657R1	1SDA068657R1
XT1	Large flange for circuit-breaker	1SDA068639R1	1SDA068640R1
XT1	Flange MOD	1SDA068648R1	1SDA068648R1
XT1	Flange for direct handle RHD	1SDA068651R1	1SDA068651R1
XT1	Flange for residual current RC Sel / Inst	1SDA068653R1	1SDA068654R1
XT2	Small flange for circuit-breaker	1SDA068657R1	1SDA068657R1
XT2	Large flange for circuit-breaker	1SDA068641R1	1SDA068642R1
XT2	Flange for MOE/MOE-E/FLD	1SDA068649R1	1SDA068649R1
XT2	Flange for MOE/MOE-E/FLD W	1SDA068650R1	1SDA068650R1
XT2	Flange for direct handle RHD	1SDA068651R1	1SDA068651R1
XT2	Flange for direct handle RHD W	1SDA068652R1	1SDA068652R1
XT2	Flange for residual current RC Sel		1SDA066647R1
XT2	Flange for residual current RC Sel W		1SDA066648R1
XT3	Small flange for circuit-breaker	1SDA068657R1	1SDA068657R1
XT3	Large flange for circuit-breaker	1SDA068644R1	1SDA068645R1
XT3	Flange for MOD	1SDA068648R1	1SDA068648R1
XT3	Flange for direct handle RHD	1SDA068651R1	1SDA068651R1
XT3	Flange for residual current RC Sel/RC Inst	1SDA068655R1	1SDA068656R1
XT4	Small flange for circuit-breaker	1SDA068657R1	1SDA068657R1
XT4	Large flange for circuit-breaker	1SDA068646R1	1SDA068647R1
XT4	Flange for MOE/MOE-E/FLD	1SDA068649R1	1SDA068649R1
XT4	Flange for MOE/MOE-E/FLD W	1SDA068650R1	1SDA068650R1
XT4	Flange for direct handle RHD	1SDA068651R1	1SDA068651R1
XT4	Flange for direct handle RHD W	1SDA068652R1	1SDA068652R1
XT4	Flange for residual current RC Sel		1SDA066649R1
XT4	Flange for residual current RC Sel W		1SDA066650R1
XT5	Flange for circuit-breaker	1SDA105139R1	1SDA105139R1
XT5	Flange for MOE/MOE-E/FLD/RHD	1SDA105137R1	1SDA105137R1
XT5	Flange for MOE/MOE-E/FLD/RHD W	1SDA105138R1	1SDA105138R1
XT5	Flange for residual current RC Sel		1SDA105135R1
XT5	Flange for residual current RC Sel W		1SDA105136R1
XT6	Flange for circuit-breaker	1SDA105142R1	1SDA105142R1
XT6	Flange for MOE/FLD/RHD	1SDA105140R1	1SDA105140R1
XT6	Flange for MOE/FLD/RHD W	1SDA105141R1	1SDA105141R1
XT7	Flange for RHD	1SDA105143R1	1SDA105143R1
XT7-XT7 M	IP30 Flange XT7-XT7 M	1SDA073862R1	1SDA073862R1
XT7-XT7 M	IP30 Flange XT7-XT7 M W	1SDA073863R1	1SDA073863R1

Ordering codes for accessories

Interlocks and switching devices

Automatic transfer devices

Rear mechanical interlock



Rear mechanical interlock - MIR-H



Plate for rear mechanical interlock

Size	Type	Code
XT1-XT2-XT3-XT4 chassis		
XT1...XT4	MIR-H	1SDA066637R1
XT1...XT4	MIR-V	1SDA066638R1
XT1	Plate XT1 F	1SDA066639R1
XT1	Plate XT1 P	1SDA066640R1
XT2	Plate XT2 F	1SDA066641R1
XT2	Plate XT2 P/W	1SDA066642R1
XT3	Plate XT3 F	1SDA066643R1
XT3	Plate XT3 P	1SDA066644R1
XT4	Plate XT4 F	1SDA066645R1
XT4	Plate XT4 P/W	1SDA066646R1
XT5 chassis		
XT5	MIR-H	1SDA105117R1
XT5	MIR-V	1SDA105119R1
XT5	Plate XT5 F	1SDA105122R1
XT5	Plate XT5 P/W 400A	1SDA105123R1
XT5	Plate XT5 P/W 630A	1SDA105124R1
XT4	Plate for XT4 F with XT5 MIR	1SDA105121R1
XT4	Plate for XT4 P/W with XT5 MIR	1SDA105125R1
XT6 chassis		
XT6	MIR-H	1SDA105118R1
XT6	MIR-V	1SDA105120R1
XT6	Plate XT6 F	1SDA105126R1
XT6	Plate XT6 W	1SDA105127R1
XT5	Plate for XT5 F with XT6 MIR	1SDA101988R1
XT5	Plate for XT5 P/W 400A with XT6 MIR	1SDA101989R1
XT5	late for XT5 P/W 630A with XT6 MIR	1SDA101990R1

Note: If the CB interlocked has a stored energy motor operator (MOE/MOE-E) a key lock between the MOL-D and MOL-S is mandatory

Cable interlock

Size	Type	Code
XT7-XT7 M	Type A horizontal	1SDA073881R1
XT7-XT7 M	Type A vertical	1SDA073885R1
XT7-XT7 M	Support for mechanical interlock FP Type A	1SDA073896R1
XT7-XT7 M	Support for mechanical interlock for fixed CB Type A - floor mounted	1SDA073893R1
XT7-XT7 M	Support for mechanical interlock for fixed CB Type A - wall mounted	1SDA073894R1
XT7-XT7 M	Type B, C, D horizontal	1SDA073882R1
XT7-XT7 M	Type B, C, D vertical	1SDA073886R1
XT7-XT7 M	Support for mechanical interlock FP Type C	1SDA101985R1
XT7-XT7 M	Support for mechanical interlock for fixed CB Type C - floor mounted	1SDA101986R1
XT7-XT7 M	Support for mechanical interlock for fixed CB Type C - wall mounted	1SDA101987R1
XT7-XT7 M	Support for mechanical interlock FP Type B-D	1SDA105128R1
XT7-XT7 M	Support for mechanical interlock for fixed CB Type B-D - floor mounted	1SDA105129R1
XT7-XT7 M	Support for mechanical interlock for fixed CB Type B-D - wall mounted	1SDA105130R1

ATS021 - ATS022 Automatic transfer devices

Size	Type	Code
XT1...XT7 M	ATS021 Automatic multi voltage transfer device	1SDA065523R1
XT1...XT7 M	ATS022 Automatic advanced control transfer device	1SDA065524R1



ATS021-ATS022 Automatic transfer devices

Ordering codes for accessories

Residual current devices

Residual current devices

Residual current devices



RC Inst / RC Sel



RC Sel

Size	Type	3 poles	4 poles
XT1	RC Sel Low 200mm		1SDA067121R1
XT1	XT1 RC Inst	1SDA067122R1	1SDA067124R1
XT1	XT1 RC Sel	1SDA067123R1	1SDA067125R1
XT2	XT2 RC Sel		1SDA067126R1
XT3	XT3 RC Inst	1SDA067127R1	1SDA067129R1
XT3	XT3 RC Sel	1SDA067128R1	1SDA067130R1
XT3	XT3 RC B-Type		1SDA067132R1
XT4	XT4 RC Sel		1SDA067131R1
XT5	XT5 RC Sel ⁽¹⁾		1SDA105131R1
XT5	XT5 RC Sel "Alarm Only" ⁽¹⁾		1SDA105132R1

(1) This can also be mounted on a three-poles circuit-breaker

Panel type residual current delay



Panel type residual current delay - RCQ020/A

Size	Type	Code
XT1...XT7 M	RCQ020/A 115-230V AC	1SDA065979R1
XT1...XT7 M	RCQ020/A 415V AC	1SDA065980R1
XT1...XT7 M	RCQ020/P 110-690 V AC	1SDA069390R1
XT1...XT7 M	Toroid closed Ø 60mm	1SDA037394R1
XT1...XT7 M	Toroid closed Ø 110mm	1SDA037395R1
XT1...XT7 M	Toroid closed Ø 185mm	1SDA050543R1

Note: Opening coil and undervoltage coil to be ordered separately



Toroid

Ordering codes for accessories

Accessories for electronic Ekip LSI, Ekip LSIG and Ekip M-LRIU trip units

Ekip LSI, Ekip LSIG and Ekip M-LRIU trip units

Accessories for electronic Ekip Dip trip units (Ekip LSI, Ekip LSIG and Ekip M-LRIU)



Ekip Display

Size	Type	Fixed/Plug-in	Withdrawable
XT2-XT4	Ekip Display	1SDA068659R1	1SDA068659R1
XT2-XT4	Ekip LED Meter	1SDA068660R1	1SDA068660R1
XT2-XT4	Ekip Com	1SDA068661R1	1SDA068662R1
XT2-XT4	HMI030 interface on front of panel	1SDA063143R1	1SDA063143R1

Connection kits



Ekip LED Meter

Size	Type	Fixed/Plug-in	Withdrawable
XT2-XT4	Kit of 24V DC auxiliary voltage for electronic trip units	1SDA066980R1	1SDA066981R1
XT2-XT4	Kit for external neutral connection	1SDA066984R1	1SDA066985R1
XT4	Kit for external neutral voltage connection	1SDA069651R1	1SDA069652R1

Ordering codes for accessories

Accessories for electronic Ekip Touch trip units

Ekip Cartridge



Ekip Cartridge

Size	Type	Code
XT2-XT4-XT5	Ekip Cartridge 2 slots XT2-XT4-XT5	1SDA105203R1
XT2-XT4-XT5	Ekip Cartridge 4 slots XT2-XT4-XT5	1SDA105204R1

Power Supply modules



Ekip Supply

Size	Type	Code
XT2...XT5- XT7-XT7 M	Ekip Supply 110-240V AC/DC	1SDA074172R1
XT2...XT5- XT7-XT7 M	Ekip Supply 24-48V DC	1SDA074173R1

Connectivity Modules

Internal modules



Ekip COM

Size	Type	Fixed/Plug-in	Withdrawable
XT2-XT4	Ekip Com Ethernet	1SDA105173R1	1SDA105173R1
XT2-XT4	Ekip Com Hub	1SDA105160R1	1SDA105160R1
XT2-XT4	Ekip Com IEC61850	1SDA105174R1	1SDA105174R1
XT2-XT4	Ekip Com Modbus RTU	1SDA105175R1	1SDA105176R1
XT2-XT4	Ekip Com Modbus TCP	1SDA105177R1	1SDA105177R1
XT2-XT4	Ekip Com Profinet	1SDA105180R1	1SDA105180R1
XT2-XT4	Ekip Link	1SDA105197R1	1SDA105197R1
XT2-XT4	Ekip Com STA Modbus TCP*	1SDA105183R1	1SDA105184R1
XT2-XT4	Ekip Com STA Modbus RTU*	1SDA105181R1	1SDA105182R1
XT5	Ekip Com Ethernet	1SDA105185R1	1SDA105185R1
XT5	Ekip Com Hub	1SDA105161R1	1SDA105161R1
XT5	Ekip Com IEC61850	1SDA105186R1	1SDA105186R1
XT5	Ekip Com Modbus RTU	1SDA105187R1	1SDA105188R1
XT5	Ekip Com Modbus TCP	1SDA105189R1	1SDA105189R1
XT5	Ekip Com Profinet	1SDA105192R1	1SDA105192R1
XT5	Ekip Link	1SDA105198R1	1SDA105198R1
XT5	Ekip Com STA Modbus TCP*	1SDA105195R1	1SDA105196R1
XT5	Ekip Com STA Modbus RTU*	1SDA105193R1	1SDA105194R1

*Ekip Com STA internal modules are also available for other trip units. For more information see chapter 4 "Communication and Connectivity", section "Internal modules"



Ekip Link

Cartridge and XT7 modules

Size	Type	Code
XT2-XT4-XT5-XT7-XT7 M	Ekip Com Modbus RTU Tmax XT	1SDA105166R1
XT2-XT4-XT5-XT7-XT7 M	Ekip Com Modbus TCP Tmax XT	1SDA105167R1
XT2-XT4-XT5-XT7-XT7 M	Ekip Com Profibus Tmax XT	1SDA105170R1
XT2-XT4-XT5-XT7-XT7 M	Ekip Com Profinet Tmax XT	1SDA105171R1
XT2-XT4-XT5-XT7-XT7 M	Ekip Com Devicenet Tmax XT	1SDA105162R1
XT2-XT4-XT5-XT7-XT7 M	Ekip Com Ethernet/IP Tmax XT	1SDA105163R1
XT2-XT4-XT5-XT7-XT7 M	Ekip Com IEC61850 Tmax XT	1SDA105165R1
XT2-XT4-XT5-XT7-XT7 M	Ekip Link Tmax XT	1SDA105172R1
XT2-XT4-XT5-XT7-XT7 M	Ekip Com Hub Tmax XT	1SDA105164R1
XT2-XT4-XT5-XT7-XT7 M	Ekip Com R Modbus RTU	1SDA074157R1
XT2-XT4-XT5-XT7-XT7 M	Ekip Com R Modbus TCP	1SDA107402R1
XT2-XT4-XT5-XT7-XT7 M	Ekip Com R Profibus	1SDA074159R1
XT2-XT4-XT5-XT7-XT7 M	Ekip Com R Profinet	1SDA107403R1
XT2-XT4-XT5-XT7-XT7 M	Ekip Com R DeviceNet™	1SDA074161R1
XT2-XT4-XT5-XT7-XT7 M	Ekip Com R EtherNet/IP™	1SDA107404R1
XT2-XT4-XT5-XT7-XT7 M	Ekip Com R IEC61850	1SDA107405R1
XT7 M	Ekip Com Actuator	1SDA074166R1

Ordering codes for accessories

Accessories for electronic Ekip Touch trip units

Signaling Modules

Internal modules

Size	Type	Fixed/Plug-in	Withdrawable
XT5	EKIP Signalling 1K-1 XT5 INT	1SDA105201R1	1SDA105202R1



Ekip 2K Signalling

Cartridge and XT7 modules

Size	Type	Code
XT2-XT4-XT5-XT7-XT7 M	Ekip Signalling 2K-1	1SDA074167R1
XT2-XT4-XT5-XT7-XT7 M	Ekip Signalling 2K-2	1SDA074168R1
XT2-XT4-XT5-XT7-XT7 M	Ekip Signalling 2K-3	1SDA074169R1
XT2-XT4-XT5-XT7-XT7 M	Ekip Signalling 3T-1 AI - Temp PT1000	1SDA085693R1
XT2-XT4-XT5-XT7-XT7 M	Ekip Signalling 3T-2 AI - Temp PT1000	1SDA085694R1
XT2-XT4-XT5-XT7-XT7 M	Ekip Signalling 10K*	1SDA074171R1

*External device



Ekip 10K Signalling

Other modules

Measuring modules

Size	Type	Code
XT7-XT7 M	Ekip Measuring module	1SDA105210R1
XT7-XT7 M	Voltage socket for neutral on right side L1 L2 L3 N	1SDA076244R1



Ekip Measuring

Internal maintenance module

Size	Type	Fixed/Plug-in	Withdrawable
XT5	EKIP Maintenance module XT5 INT	1SDA105199R1	1SDA105200R1

Synchrocheck module

Size	Type	Code
XT2-XT4-XT5-XT7-XT7 M	Ekip Synchrocheck	1SDA074183R1

Contactor interface module

Size	Type	Code
XT2-XT4-XT5- XT7-XT7 M	Ekip CI	1SDA105205R1

External 3T signaling probe module

Size	Type	Code
XT2-XT4-XT5- XT7-XT7 M	External probe PT1000 3mt	1SDA085695R1

Options for Ekip electrical trip units

Size	Type	Code
XT7-XT7 M	Upper internal installed voltage outlets	1SDA074216R1
XT7-XT7 M	External installed voltage outlets	1SDA074217R1
XT7-XT7 M	Arrangement for cables with lower internal voltage outlets	1SDA074213R1
XT7-XT7 M	Arrangement for cables with upper internal voltage outlets	1SDA074214R1
XT7-XT7 M	Arrangement for cables with external voltage outlets	1SDA074215R1
XT7-XT7 M	RTC Ekip 24V	1SDA073772R1
XT7-XT7 M	AUP Ekip auxiliary position contact	1SDA073768R1



Ekip RTC contacts

Connection kits

Size	Type	Fixed/Plug-in	Withdrawable
XT2-XT4	Con.Kit 24V/IntBus/ExtNeut/Sel	1SDA101979R1	1SDA105206R1
XT2-XT4	Kit for external neutral voltage connection	1SDA101978R1	
XT2-XT4	Kit zone selectivity XT2-XT4 Ekip Touch	1SDA113126R1	
XT5	Kit for external neutral voltage connection	1SDA107391R1	1SDA107392R1
XT5	Kit Ext NE C+V sensor XT5 Ekip Touch	1SDA107393R1	1SDA107393R1
XT5	Kit Ext NE C sensor XT5 Ekip Touch	1SDA107394R1	1SDA107394R1
XT5	Kit Ext NE V sensor XT5 Ekip Touch	1SDA107395R1	1SDA107395R1
XT5	Kit Ext NE sensor XT5 Ekip Dip	1SDA107396R1	1SDA107396R1
XT5	Kit zone selectivity XT5 Ekip Touch	1SDA113125R1	1SDA107397R1
XT5	Connection Kit 24Vdc/Internal Bus XT5 W		1SDA105207R1
XT2-XT4-XT5	Terminal block din rails with 5 positions	1SDA101976R1	1SDA101976R1
XT2-XT4-XT5	Terminal block din rails with 10 positions	1SDA101977R1	1SDA101977R1

Ordering codes for accessories

Accessories for electronic Ekip Touch trip units

Advanced functionality

Packages

Size	Type	Code
XT2-XT4	Measuring package for XT2-XT4	1SDA105208R1
XT2-XT4	Adaptive protection for XT2-XT4	1SDA105221R1
XT2-XT4	Frequency protection for XT2-XT4	1SDA105215R1
XT2-XT4	Power protection for XT2-XT4	1SDA105217R1
XT2-XT4	ROCOF protection for XT2-XT4	1SDA105219R1
XT2-XT4	Advanced voltages protection for XT2-XT4	1SDA105213R1
XT2-XT4	Voltages protection for XT2-XT4	1SDA105211R1
XT5-XT7-XT7 M	Datalogger for XT5-XT7	1SDA105224R1
XT5-XT7-XT7 M	Network analyzer for XT5-XT7	1SDA105226R1
XT5-XT7-XT7 M	Measuring package for XT5-XT7	1SDA105209R1
XT5-XT7-XT7 M	Adaptive protection for XT5-XT7	1SDA105222R1
XT5-XT7-XT7 M	Frequency protection for XT5-XT7	1SDA105216R1
XT5-XT7-XT7 M	Power protection for XT5-XT7	1SDA105218R1
XT5-XT7-XT7 M	ROCOF protection for XT5-XT7	1SDA105220R1
XT5-XT7-XT7 M	Advanced voltages protection for XT5-XT7	1SDA105214R1
XT5-XT7-XT7 M	Voltages protection for XT5-XT7	1SDA105212R1

Solutions

Size	Type	Code
XT2-XT4-XT5-XT7-XT7 M	IPS - Interface protection	1SDA082919R1
XT2-XT4-XT5-XT7-XT7 M	Load shedding - adaptive	1SDA082921R1
XT2-XT4-XT5-XT7-XT7 M	Load shedding - predictive	1SDA082922R1
XT2-XT4-XT5-XT7-XT7 M	Synchro reclosing	1SDA082923R1
XT2-XT4-XT5-XT7-XT7 M	ATS License main-tie-main closed	1SDA082886R1
XT2-XT4-XT5-XT7-XT7 M	ATS License main-main closed	1SDA082888R1
XT2-XT4-XT5-XT7-XT7 M	ATS License main-tie-main open	1SDA082887R1
XT2-XT4-XT5-XT7-XT7 M	ATS License main-main open	1SDA082889R1
XT2-XT4-XT5-XT7-XT7 M	Ekip Power controller	1SDA074212R1

Metering functionality

Size	Type	Code
XT2-XT4	Class 1 Power & Energy Metering ⁽¹⁾	1SDA107492R1
XT5-XT7	Class 1 Power & Energy Metering ⁽¹⁾	1SDA107493R1

(1) Factory mounted only

Display and supervision systems

Display and supervision systems



Ekip Multimeter Display

Size	Type	Code
XT2-XT4-XT5-XT7-XT7 M	Ekip Programming	1SDA076154R1
XT2-XT4-XT5-XT7-XT7 M	Ekip Multimeter display on front of switchboard	1SDA074192R1
XT2-XT4-XT5-XT7-XT7 M	Ekip Control panel for 10 circuit-breakers	1SDA074311R1
XT2-XT4-XT5-XT7-XT7 M	Ekip Control panel for 30 circuit-breakers	1SDA074312R1
XT2-XT4-XT5-XT7-XT7 M	Ekip View software for 30 circuit-breakers	1SDA074298R1
XT2-XT4-XT5-XT7-XT7 M	Ekip View software for 60 circuit-breakers	1SDA074299R1
XT2-XT4-XT5-XT7-XT7 M	Ekip View software for unlimited circuit-breakers	1SDA074300R1

Ordering codes for accessories

Other accessories for trip units

Test and configuration

Test and configuration

Size	Type	Code
XT2-XT4-XT5- XT6-XT7-XT7 M	Ekip TT - Trip test unit	1SDA066988R1
XT2-XT4-XT5- XT6-XT7-XT7 M	Ekip T&P - Programming and test unit	1SDA066989R1
XT2-XT4-XT5- XT6-XT7-XT7 M	Ekip Bluetooth key	1SDA101980R1

Current sensor

Current sensor for neutral conductor outside the circuit-breaker

Size	Type	Code
XT2	CT External neutral 10A Ekip Dip	1SDA067211R1
XT2	CT External neutral 25A Ekip Dip	1SDA067212R1
XT2	CT External neutral 63A Ekip Dip	1SDA069142R1
XT2	CT External neutral 100A Ekip Dip	1SDA069143R1
XT2	CT External neutral 160A Ekip Dip	1SDA069144R1
XT2	CS External neutral $\leq 63A$ Ekip Touch	1SDA101970R1
XT2	CS External neutral $\geq 100A$ Ekip Touch	1SDA105150R1
XT2	CS External neutral $\leq 63A$ Ekip Touch with voltage	1SDA107398R1
XT2	CS External neutral $\geq 100A$ Ekip Touch with voltage	1SDA107399R1
XT4	CT External neutral 40A Ekip Dip	1SDA066975R1
XT4	CT External neutral 63A Ekip Dip	1SDA066976R1
XT4	CT External neutral 100A Ekip Dip	1SDA066977R1
XT4	CT External neutral 160A Ekip Dip	1SDA066978R1
XT4	CT External neutral 250A Ekip Dip	1SDA066979R1
XT4	CS External neutral IEC Ekip Touch	1SDA105151R1
XT4	CS External neutral Ekip Touch with voltage	1SDA107400R1
XT5	CT External neutral 250A Ekip Dip	1SDA101966R1
XT5	CT External neutral 320A Ekip Dip	1SDA105153R1
XT5	CT External neutral 400A Ekip Dip	1SDA105154R1
XT5	CT External neutral 630A Ekip Dip	1SDA105156R1
XT5	CS External neutral Ekip Touch	1SDA105157R1
XT5	CS External neutral Ekip Touch with voltage	1SDA107401R1
XT6	CT External neutral 630A Ekip Dip	1SDA107672R1
XT6	CT External neutral 800A Ekip Dip	1SDA105158R1
XT6	CT External neutral 1000A Ekip Dip	1SDA105159R1
XT7-XT7 M	CS External neutral up to 2000A	1SDA073736R1



Current sensor



Homopolar sensor

Homopolar toroid for the earthing conductor of the main power supply

Size	Type	Code
XT7-XT7 M	Homopolar toroid 100A	1SDA073743R1
XT7-XT7 M	Homopolar toroid 250A	1SDA076248R1
XT7-XT7 M	Homopolar toroid 400A	1SDA076249R1
XT7-XT7 M	Homopolar toroid 800A	1SDA076250R1
XT7-XT7 M	Toroid RC 3p	1SDA073741R1



Toroid RC

Rating plug for Ekip trip units



Rating plug

Rating plug

Size	Type	Loose supply	Installed
XT5	Rating plug In=250A	1SDA101991R1	
XT5	Rating plug In=320A	1SDA101994R1	
XT5	Rating plug In=400A	1SDA101995R1	
XT5	Rating plug In=500A	1SDA101997R1	
XT5	Rating plug In=630A	1SDA102000R1	
Ekip Dip LS/I, Ekip Dip LIG, Ekip M-I, Ekip Dip G-LS/I - BASIC Trip Units			
XT7-XT7 M	Rating plug In=630 A XT7-XT7 M	1SDA107617R1	1SDA107623R1
XT7-XT7 M	Rating plug In=800 A XT7-XT7 M	1SDA102011R1	1SDA102013R1
XT7-XT7 M	Rating plug In=1000 A XT7-XT7 M	1SDA102014R1	1SDA102016R1
XT7-XT7 M	Rating plug In=1250 A XT7-XT7 M	1SDA102018R1	1SDA102019R1
XT7-XT7 M	Rating plug In=1600 A XT7-XT7 M	1SDA102020R1	
Ekip Dip LSI, Ekip Dip LSIG, Ekip Touch all			
XT7-XT7 M	Rating plug In=630 A XT7-XT7 M	1SDA107619R1	1SDA107621R1
XT7-XT7 M	Rating plug In=800 A XT7-XT7 M	1SDA102001R1	1SDA102003R1
XT7-XT7 M	Rating plug In=1000 A XT7-XT7 M	1SDA102004R1	1SDA102006R1
XT7-XT7 M	Rating plug In=1250 A XT7-XT7 M	1SDA102008R1	1SDA102009R1
XT7-XT7 M	Rating plug In=1600 A XT7-XT7 M	1SDA102010R1	
XT7-XT7 M	Rating plug RC In=800A XT7-XT7 M	1SDA102021R1	1SDA102022R1
XT7-XT7 M	Rating plug RC In=1250A XT7-XT7 M	1SDA102023R1	1SDA102024R1

ABB SACE S.p.A.
Electrification business
Smart Power business line

5, Via Pescaria
I-24123 Bergamo - Italy
Phone: +39 035 395.111

go.abb/xt



Stay tuned. Discover more by visiting the webpage reserved to SACE Tmax XT and be always up-to-date with the latest edition of the catalogue.